

# Ersa Rework & Inspection Systems

We take care of excellent worldwide joints

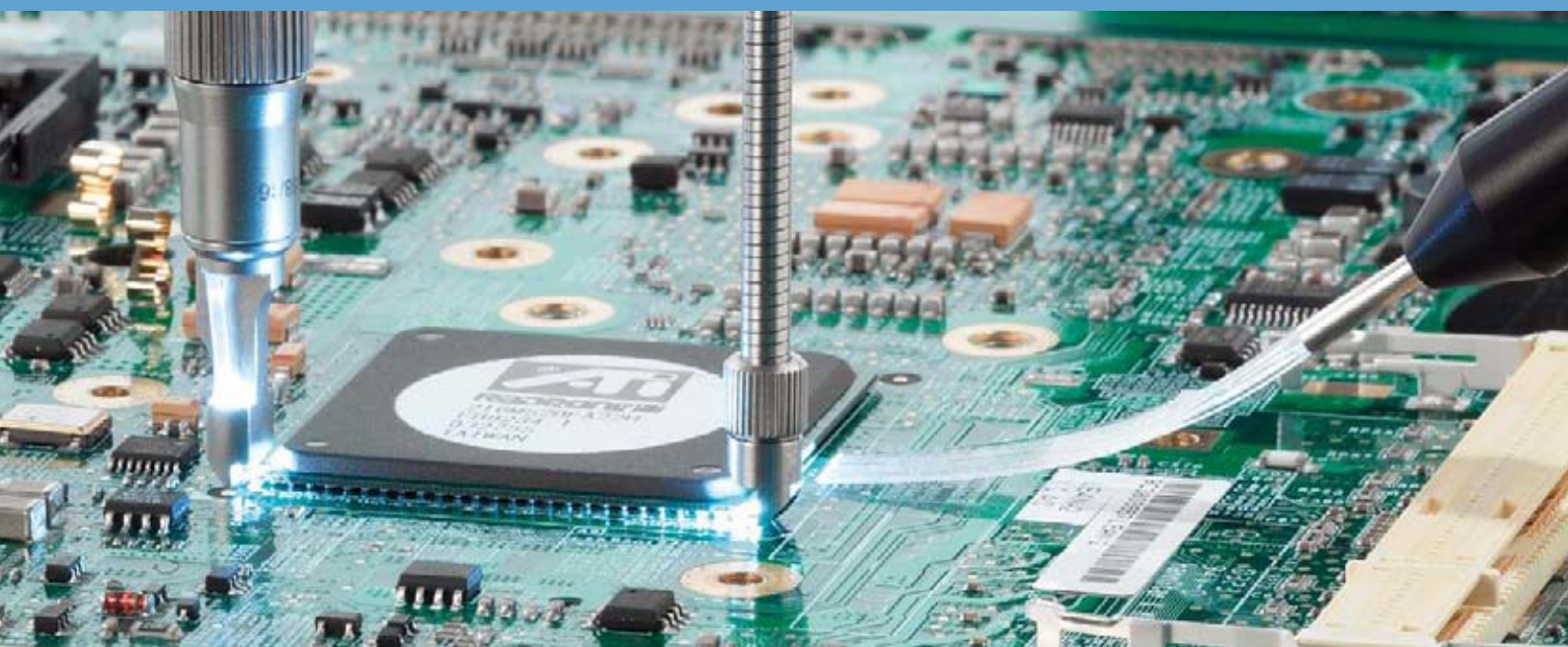

# Content

## Ersa Rework Systems

HR 600 .....	4 - 5
HRSOft .....	6
Dip&Print Station .....	7
IR/PL 650 .....	8
IR 650 .....	9
RPC 650 .....	12
PL 650 .....	13
IR/PL 650 XL .....	14 - 15
IR/PL 550 .....	16
IR 550 .....	17
PL 550 .....	18
RPC 500 .....	19
HR 100 & IRHP 100 .....	20 - 21
IRSOft .....	22 - 23
<b>Accessories</b>	
Placement nozzles & suction cups .....	26
Temperature sensors .....	27
Additional equipment .....	27
Consumable items .....	28
Solder tips .....	28
PCB tables & holders .....	29
Baffles HR 600 .....	30
Dip&Print Station .....	30

## Ersa Inspection Systems

ERSASCOPE 2 .....	36 - 39
ERSASCOPE 1 .....	40 - 41
MOBILE SCOPE .....	42 - 43
ImageDoc .....	44 - 46
<b>Inspection system configurations &amp; optional items</b>	
ERSASCOPE 2 .....	48
ERSASCOPE 1 .....	49
MOBILE SCOPE .....	50



# Ersa Rework- & Inspection Systems

## Award-winning and a class of its own!

Over the past two decades, rework & repair of electronic assemblies has been one of the most exciting and challenging undertakings in the industry. The increasing complexity of the PCBs, as well as the advancements in packages has put additional demands on both rework specialists and their equipment. Applications oriented, innovative solutions are the key to success in this demanding field.

Ersa took on the rework challenge almost fifteen years ago as it introduced its first patented medium wavelength infrared rework system, the Ersa IR 500. Today, we are proud to boast one of the world's largest installed equipment bases of over 6,000 systems ranging from smaller bench top units to larger semi-automated machines. Ersa rework systems have proven themselves to be the undisputed leader in handling the largest variety of rework applications. From the smallest 0201 up to

the largest SMT connector (120 mm), from SMT Flip Chips to THT Pin Grid Arrays, from BGA on flex circuit to stacked BGAs and from metal shields to plastic processor sockets, the safe IR technology handles it all.

Now recognized as one of the market leaders in the rework field, Ersa is happy to present its most complete range of products in this new Rework Catalog.

Now for nearly fifteen years, thousands of users worldwide are benefiting from the ability to inspect hidden solder joints with the patented & award winning ERSASCOPE inspection technology.

Industry experts recognize the critical importance of using ERSASCOPE technology for the inspection of hidden solder joints. In combination with x-ray inspection equipment, the ERSASCOPE provides the most complete view of potential problems.

ERSASCOPE remains to be the undisputed industry standard for optically inspecting BGAs & other hidden solder joints!

Whether for inspection under Flip Chips or for inspection where other microscopes cannot see, ERSASCOPE technology offers a significant added value to any quality assurance program.

### Our Portfolio

- Stencil printers
- Reflow systems
- Selective soldering systems
- Wave soldering systems
- Rework systems
- Inspection systems
- Soldering stations
- Solder fume extraction units
- Solders, fluxes & more
- Staff training & certification



# Ersa Hybrid Rework System HR 600

## Flexible, efficient, automated, reliable!

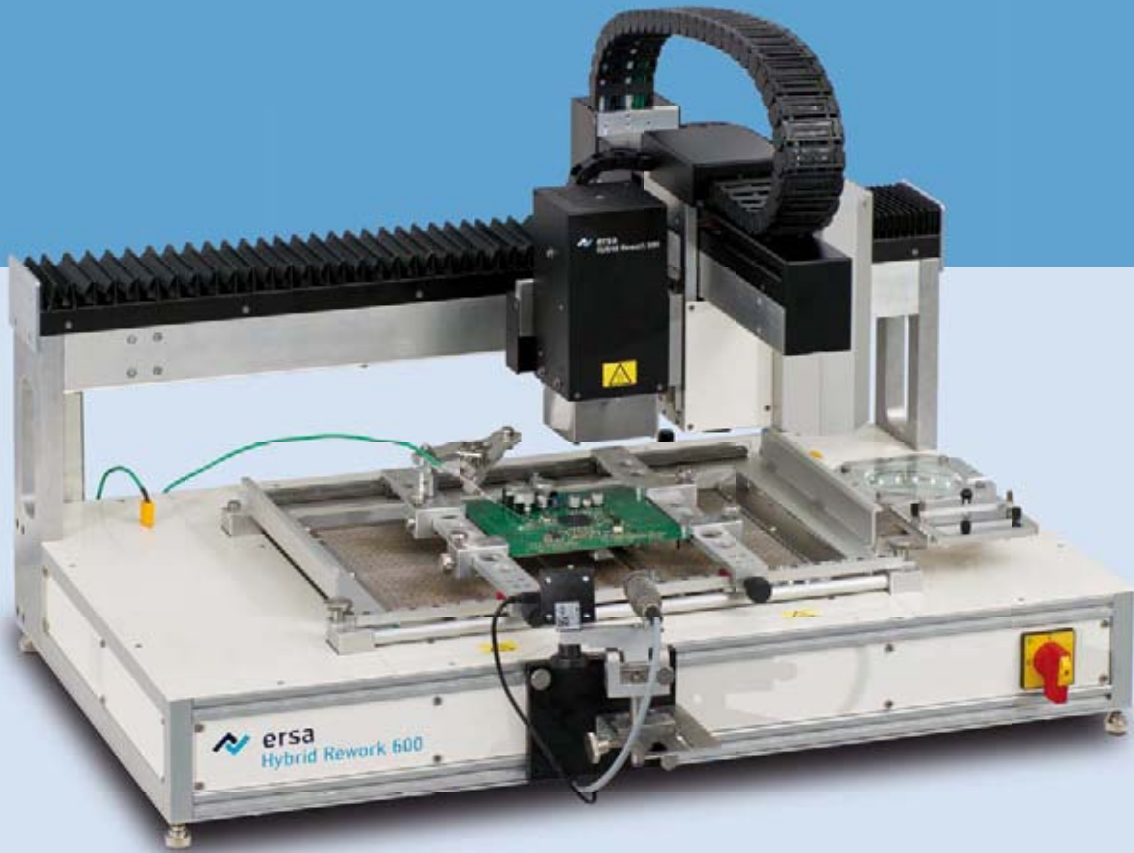

### Ersa High-End-Rework

The task formulated for the Ersa HR 600 Hybrid Rework System was to offer professional, automated rework of sub-assemblies for the electronic industry. With the system now at hand, almost all high pin-out components that may be found on modern board assemblies, and of virtually any shape, can be reliably reworked. The core competencies of this universal rework system are the placement of components, their lifting off and their controlled setting down, as well as the soldering process.

Special attention was given to the automation of the individual process steps. All operations can be controlled in a step-by-step mode by the operator himself, or they can be combined into an automated operation, requiring very few interventions by the operator.

To preheat the complete board area of the assembly mounted in the board holder, the system utilizes highly dynamic IR-heating elements in the lower heater cassette. A hybrid heating head combines the heat transfer method of IR radiation with that of

convection heating for a targeted, and therefore highly efficient, warming of the components to be worked on. Applying this method, quick and top-quality desoldering and soldering results are being achieved. An optional Reflow-Process-Camera (RPC) with LED illumination is available for process monitoring and documentation.

Component placement is a largely automatic process; integrated image processing software assesses data supplied by the two installed cameras. The component position is calculated and placed using a vacuum pipette mounted on an axis-system.

The system is prepared for the Ersa Dip&Print frame. Paste printing takes place off-side on the Dip&Print station; fluxing the component is equally a fully automated process.

#### Ordering information:

Order number	Description
<b>OHR600</b>	<b>Ersa HR 600</b> , Hybrid Rework System
<b>OHR610</b>	<b>Ersa Reflow Process Camera</b> for HR 600, complete
<b>OPR100</b>	<b>Ersa Dip&amp;Print Station</b> , complete

# Ersa HR 600

## Rework of board assemblies newly defined



*Desoldered PLCC component*



*Hybrid heating head with interchangeable baffles*

The heating area of the top side hybrid heating head can be limited by two separately controllable heating zones.

In conjunction with the controllable zones, high grade stainless steel baffles can be inserted to further help limit the heating area. These baffles are available in the sizes of 40 x 40 mm, 30 x 30 mm, 20 x 20 mm and one with a diameter of 10 mm.

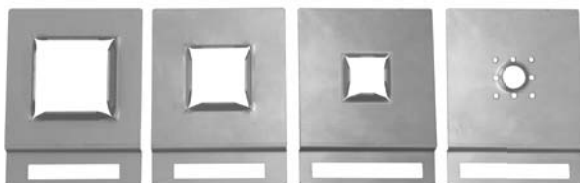

### Features HR 600 and RPC

- High performance hybrid heating head with 2 heated zones (800 W)
- Three lower programmable IR heating zones (2,400 W)
- Temperature acquisition by 3 channels – 1 IRS sensor, 2 AccuTC thermocouples (K-type)
- Board size up to 285 (+x) x 90 mm
- Motorized heating head with vacuum pipette
- Interchangeable baffles
- Cooling with hybrid head and compressed air-knife from below
- Laser pointer for component ID and board location
- Precision axis system with stepper motors
- 2 high quality USB 2.0 cameras and image processing
- Adaptive LED illumination
- Able to handle components from sizes 1 x 1 mm up to 50 x 50 mm
- Positional accuracy up to +/- 0.025 mm
- PC interface via USB port
- Operation via HRsoft
- High resolution USB 2.0 camera for process monitoring (optional)
- Dimmable LED pointer for RPC
- Multiply adjustable RPC holder

# HRSoft – The combination of proven technology and innovative image processing sets new standards!

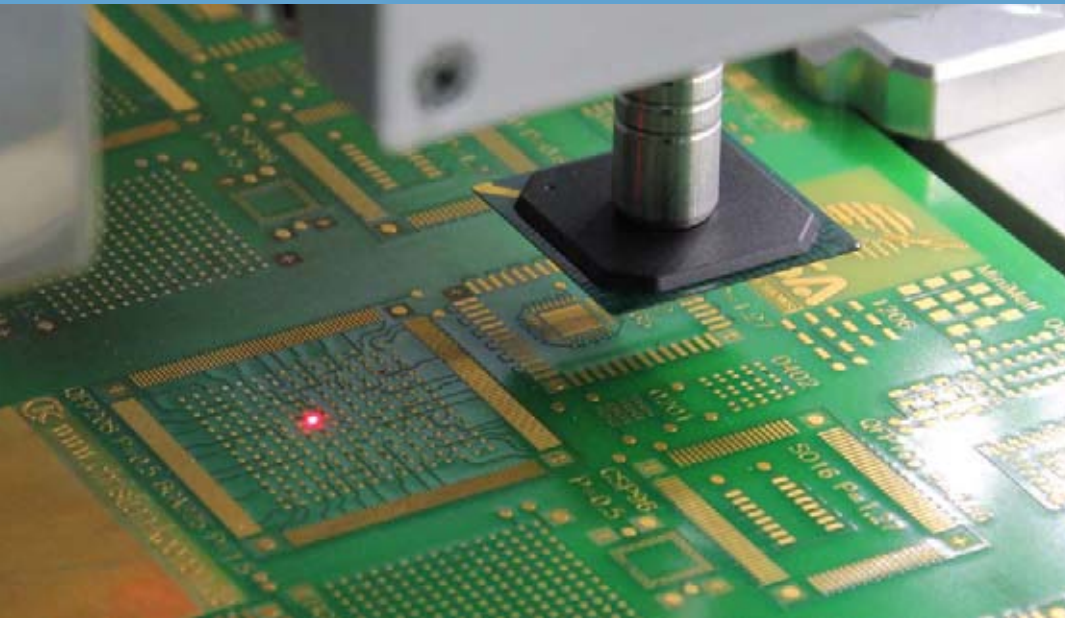

By continuing the development of the universal control software platform of IRSoft, a new control software has been created for the HR600 called HRSoft. All of the process steps of the HR600 are supported by this user friendly software. Through HRSoft the user can manually control all functions of the system with the simple click of a mouse. During a rework process the user can select to operate the HR600 in either a single step mode or an automatic mode.

The library feature of HRSoft clearly displays the stored soldering and desoldering temperature profiles. A soldering or desoldering process can be started either manually or automatically and regardless of the starting method the results are automatically recorded.

For placing the new component, the

single step mode or the automatic process mode are again available. At all times the individual functions of the system, axis and cameras can be manually controlled.

The integration of an optional USB reflow process camera (RPC) for the HR 600 is also provided for. This high-resolution camera with a wide-aperture lens and a LED point light source visualizes the solder process in real time. The compact RPC camera is mounted on a movable slide at the front of the unit. Height, inclination and tilt angle can be adjusted so that the optimal view on the solder joint is assured for all applications.

Last but not least, in addition to the automated operation of the HR 600, HRSoft offers an archive, in which all recorded data of the rework processes is administered and stored.



*Image of the target position*

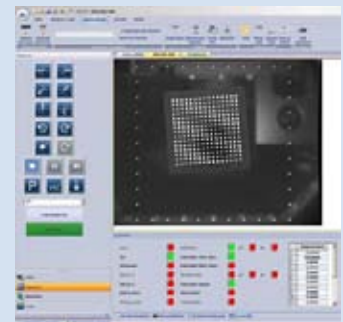

*Determining the component connection points*



*Superimposing of component and target position*



*HRSoft process recording*

# Dip&Print Station for Erska Rework Systems

*Removal of the component from the printing stencil*



The Erska Dip&Print Station enables the user of an Erska Rework system to easily, reliably and reproducibly perform the preparatory work on the component (application of solder paste or flux).

Optional dipping stencils permit - using defined parameters - to immerse the components into flux and in solder paste, building up a defined depot on the contacts to be soldered. This method is suitable for BGA's and for most fine pitch components. For example, using a component specific stencil, solder paste depots on QFN / MLF connections and those of other SMD components can be easily and precisely added.

In the printing process, the solder paste is printed from below on the component, which during this time is held in the stencil, from where it subsequently is lifted out by the placement unit and placed on the target position.

A suitable rack fixation is found on each Erska Rework system to mount the stencil frame of the Dip&Print station on the placing system.



*Flux deposition in the dipping stencil*

## Ordering information:

Order number	Description
<b>OPR100</b>	<b>Dip&amp;Print Station</b>
<b>OPR100-PL550</b>	<b>Rack fixation PL 550</b>
<b>OPR100-PL650</b>	<b>Rack fixation PL 650</b>



*Dip&Print Station with accessories*

## Features Dip&Print Station

- Easy solder paste printing
- Components dipped for flux and solder paste deposition
- Fits to all Erska Rework Systems
- Easily changeable stencils
- Easy to clean system components

# Ersa IR/PL 650

## The Ersa Rework power-pack for demanding applications

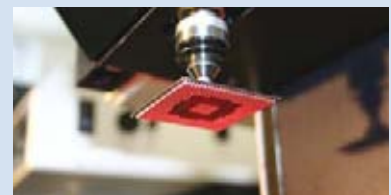

*"Auto Pick & Place" allows for rapid, precise and repeatable results!*



*Real-time rework process visualization of BGA during reflow*

The IR/PL 650 provides a very high heating power (4,400 W) for large and complex PCBs. Offering a high degree of automation, the IR/PL 650 requires only little user intervention. This guarantees stable and repeatable rework processes for all applications.

***The IR Rework system is made up of four distinct operational modules:***

- I. IR 650 Selective Reflow module***
- II. RPC 650 Camera module***
- III. PL 650 Placement module***
- IV. IRSofT Software module***

### **Recommended Accessories:**

It is recommended to purchase: Split Optic Kit for placing large PQFPs, Component Centering Station for alignment of fine pitch components and the Rework Starter Kit. Special desoldering tools, such as the CHIP TOOL for small SMD removal and the X-TOOL for TH desoldering can be used with the solder station integrated into this system. For ordering details, please refer to the Ersa Soldering Tools catalog or visit [www.ersa.com](http://www.ersa.com). A complete listing of all rework accessories can be found on pages 26 through 30.





# Ersa IR 650

## Selective BGA/SMT Reflow Technology for Rework

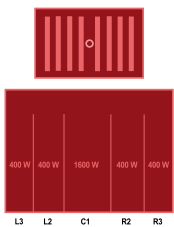
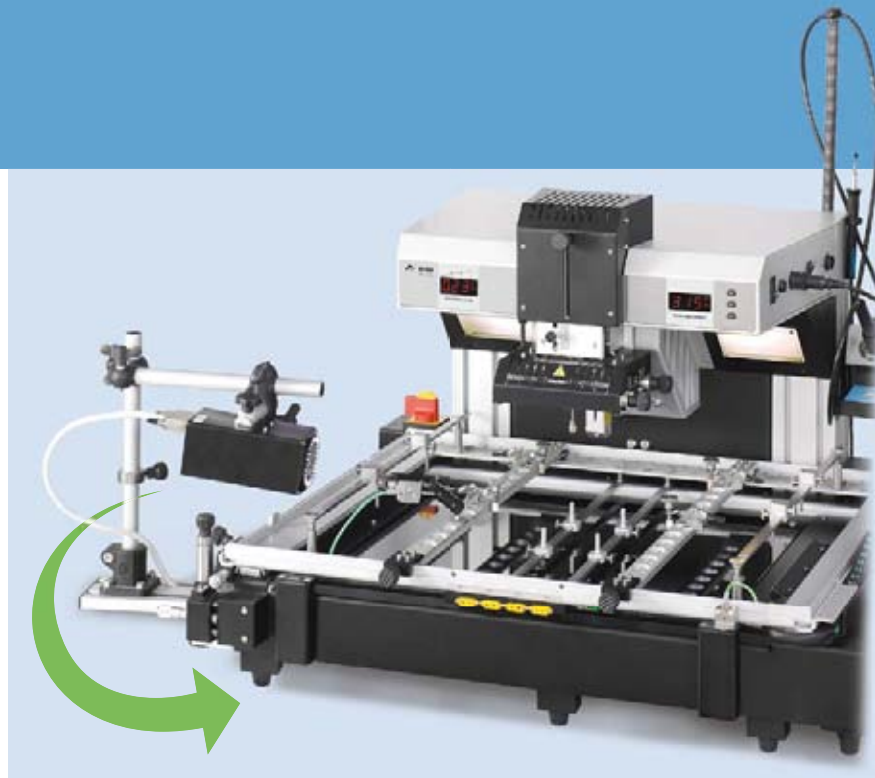

The 4,600 W DynamicIR system has 4 top and 5 bottom heating zones

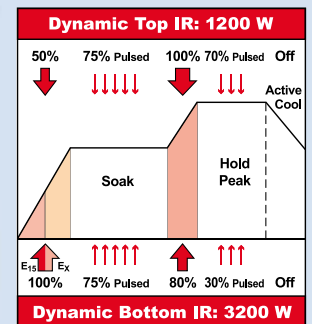

The IR 650 Selective Reflow Module uses DynamicIR heating technology for fully automatic dynamic control of the top (1,200 W / 60 mm x 120 mm) and bottom (3,200 W / 350 mm x 450 mm) IR heaters. The total available power (4,400 W) to the selective reflow system is spread across 4 separately controllable heating zones on the top and 5 zones on the bottom. Depending on board size, the thermal mass of the substrate, and

component size, the DynamicIR technology guarantees that the required heat energy is delivered at the precise time and location in order to ensure that the component and board exactly follow the prescribed temperature profile.

Now combined with the enhanced capability to run an extended or flat peak, this revolutionary technology affords the lowest temperature deltas across the component, the highest degree of process safety and greatly reduces PCB warpage.

### Features IR 650 Modul

- Four programmable heating zones, top (1.200 W)
- Five programmable heating zones, bottom (3.200 W)
- PCB size up to 560 mm x 460
- 5 channel temperature recording: 1 IRS sensor, 4 AccuTC thermocouples (K-type)
- DynamicIR & Multi True Closed Loop controlled selective reflow process with APR
- Laser pointer for component ID & PCB positioning
- Motorized reflow head with vacuum pipette
- Removable PCB fixing frame with top & bottom side center supports
- Integrated axial top & laminar bottom cooling fans
- Component handling vacuum pen
- Integrated digital soldering station with soldering iron
- PC ready via USB
- Operation and monitoring via IRSoft

### Ordering information:

Order number	Description
<b>0IR650A</b>	<b>IR Rework System IR 650 with RPC 650 Module</b> incl. IRSoft, 2 pcs. AccuTC, 1 pc. Flexpoint TC holder, integrated cooling fans & soldering station

# DynamicIR Heating Technology

## Multiple-True-Closed-Loop

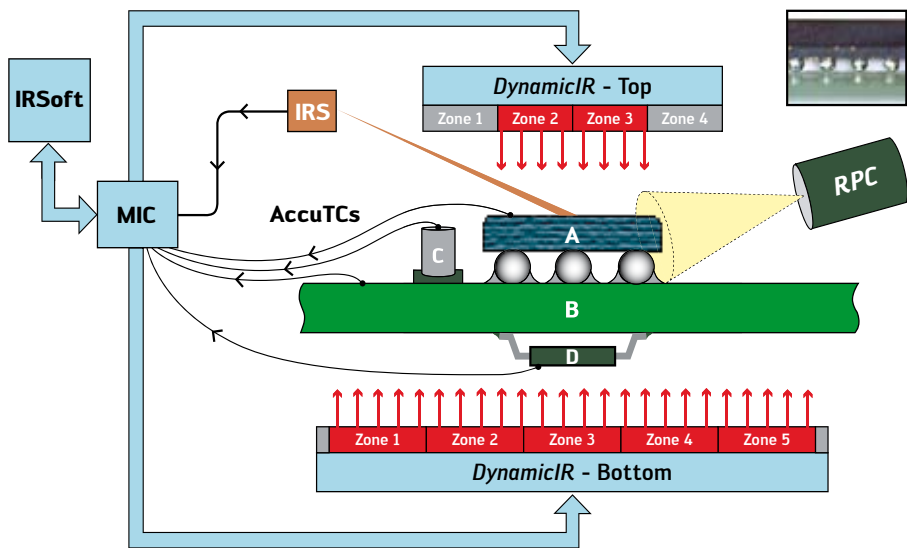

- A: Component for Rework
- B: PCB
- C: Adjacent component top side
- D: Adjacent component bottom side
- AccuTCs: Thermal Couples
- IntelligentIRS: Non Contact Infrared Sensor
- DynamicIR Top: Top IR radiator
- DynamicIR Bottom: Bottom IR radiator
- RPC: Reflow Process Camera
- IRSoft: Control and Documentation Software
- Mic: Microprocessor controls the DynamicIR heating system

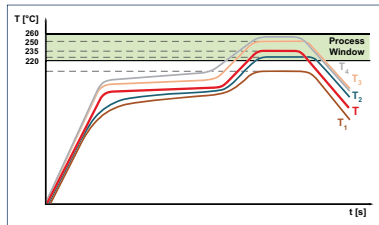
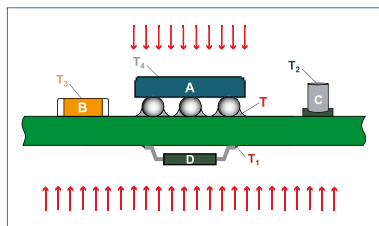

MTCL Control guarantees Process Safety!

Ersa's proven Multiple True Closed Loop Selective Rework technology uses the actual temperature of the component and/or PCB to drive the DynamicIR heating system. The non-contact IntelligentIRS infrared sensor offers a comfortable, in-process temperature measurement of the component to be heated and guarantees that it exactly follows the prescribed profile path. The power to the medium wavelength IR heaters is controlled based on the precise temperature gradient of the component required at each specific time point in the profile. Up to four additional AccuTC K-type thermocouples can monitor temperatures at four additional locations in order to prevent the system from undesired overheating of temperature sensitive components.

The DynamicIR heating technology offers a multiple zone, optimized reflow process with either 1,600 W or 4,400 W of total heating power. The RPC Reflow Process Camera offers enhanced safety by visualizing the rework process. Finally, the new IRSoft Control & Documentation Software provides a user-friendly, command & control interface.

# APR – Auto Process Repetition

## Ultimate Rework Process Stability through automatic process repetition function

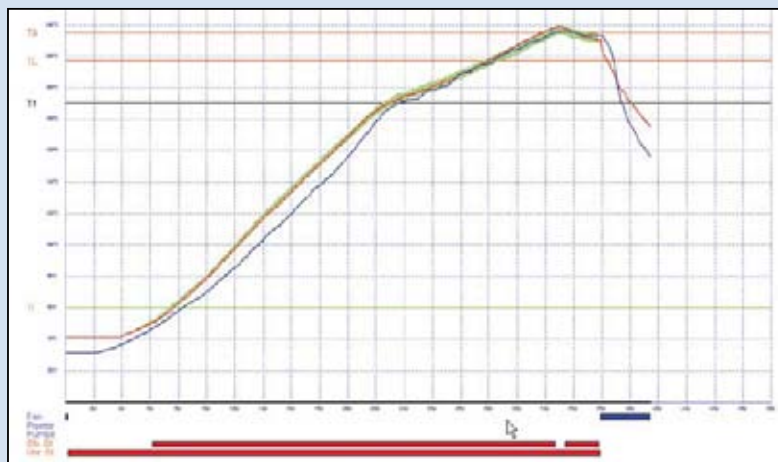

All PCBs follow the exact same temperature profile



User-friendly operating interface

Today's rework operators have many different challenges, sometimes high mix and other times high volumes. Quite often operators must perform completely different removals and replacements on a large mix of different boards.

For these applications, Ersas Multiple True Closed Loop Process offers the highest degree of safety available on the market. Other times, however, operators must perform the exact same operation on hundreds or thousands (high volumes) of boards and must guarantee safety and repeatability. For these applications, Ersas now introduces the Ersas APR – Auto Process Repetition for automated selective rework. Similar to how our in-line selective soldering systems

function, APR allows the operator to establish the perfect closed loop profile using the multiple sensors provided. The system records the exact power control of the top and bottom heaters and their zones over the entire time cycle of the process.

After verifying the optimal profile, the boards for repeated high volume rework can be placed into the system one-by-one and each and every PCB will be subjected to the exact same selective reflow process. Speed, safety and ultimate process repeatability are the added value benefits of this important new rework function.

### APR Features

- Rework Process Stability for high repetition applications
- Multiple sensor, closed loop profiling
- Auto recording of all heating parameters
- Auto repetition of system heating control
- For use with the IR 650, IR/PL 650 XL & IR 550 systems
- APR Control via IRSoft

# Ersa RPC 650 Reflow Process Camera



*Live Video  
Pop-Up window  
during profile  
recording*

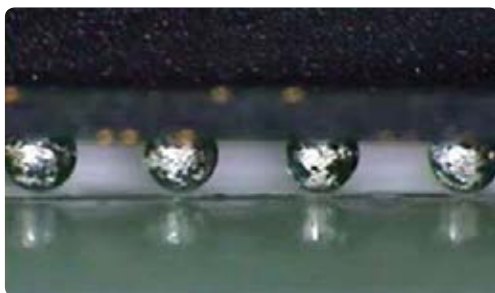
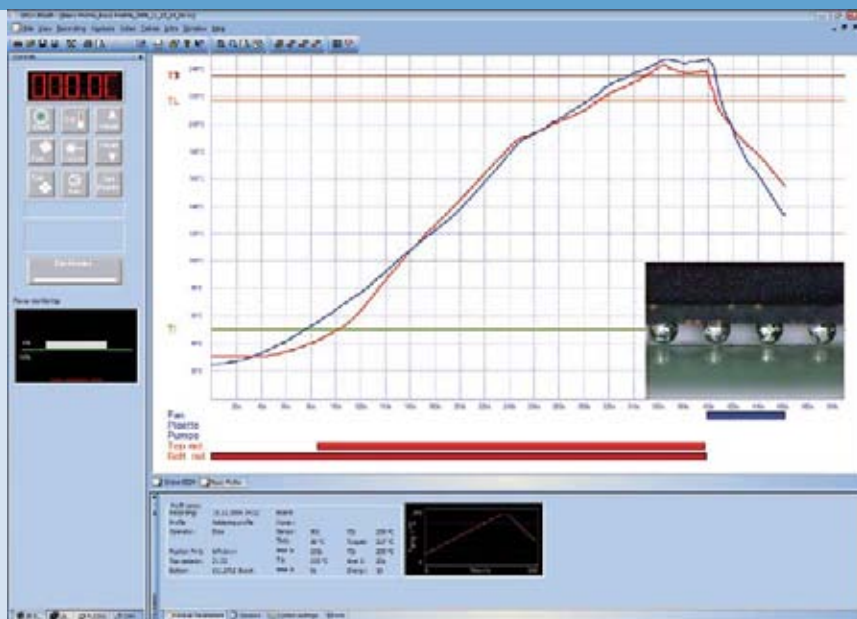

*Real-time rework process visualization of BGA during reflow*



*RPC Camera with LED ring light*

The RPC 650 Module is attached to the IR 650 module and uses a new high-power (up to 300x enlargement) motor zoom camera, a controllable LED ring lighting system, and an movable swivel arm in order to visualize the rework process real time. The reflow process can be viewed from various angles and high magnification on even the smallest of components.

The reflow process can be viewed in great detail under different angles and with high magnification, so that even the smallest components can be clearly observed.

Through the real-time observation of the soldering and desoldering process, the user can capture the melting point of the solder and directly calibrate the unit. This feature substantially improves process reliability.

## Features RPC 650 Modul

- CCD camera with 25 x optical and 12 x digital zoom
- Motorized zoom and focus
- LED ring light, one push auto focus and white balance
- Programmable camera presets
- Multiple angle, movable and fixable swivel
- Remote control via mouse or PC using IRSoft

# Ersa PL 650

## Precision Component Placement

*"Auto Pick & Place"  
allows for rapid,  
precise & repeatable  
results!*

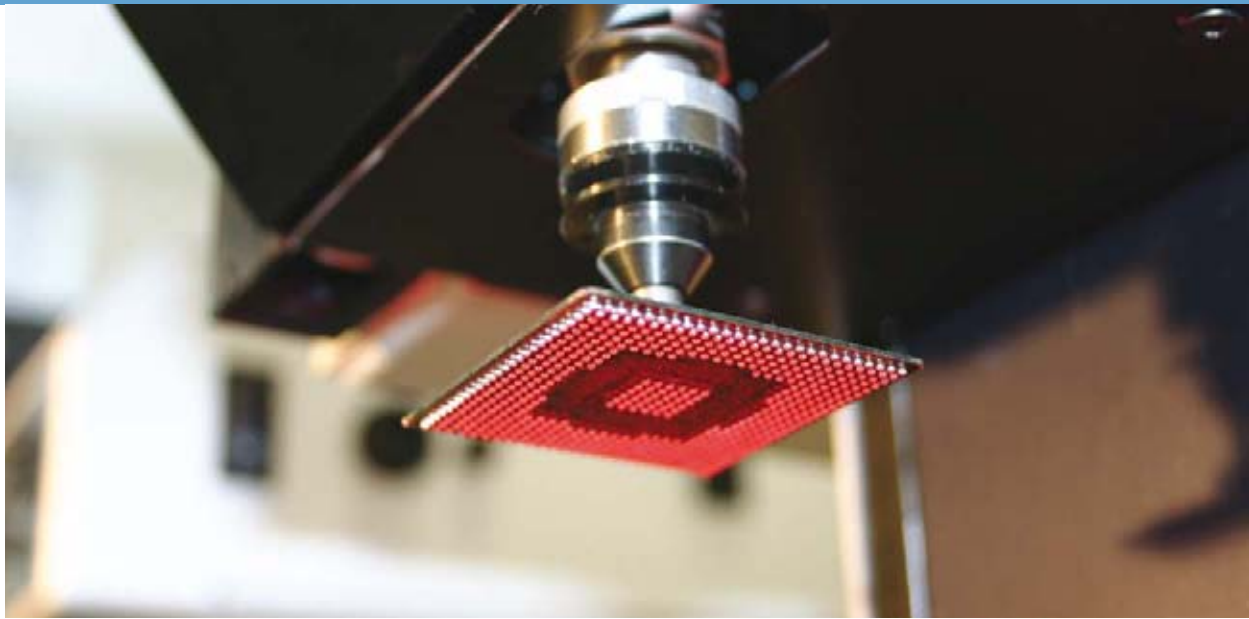

The PL 650 Module is the second generation precision placement system designed for the largest range of components, increased automation, and guaranteed repeatability. A highly sophisticated and fully automated, pressure triggered component placement head drops off the component at the same contact pressure (2 – 3 N) as an in-line Pick & Place machine.

A high-resolution camera with motorized zoom permits highly precise alignment of component leads to lands with up to 300x enlargement. The excellent image quality is supported by a high-contrast, separately controlled 2 colour LED lighting system from four sides. The Auto Pick & Place mode guarantees repeatable and precise results.

### Features PL 650 Modul

- CCD camera with 25 x optical and 12 x digital zoom
- Motorized head, prism cassette, zoom and focus
- Pressure triggered head with automatic drop off
- "Auto Pick" & "Auto Place" with +/- 0.010 mm accuracy
- Component handling from 1 x 1 mm to 60 x 60 mm
- 60 x 60 mm split optic cassette for large QFPs and BGAs (optional)
- Four side red/white LED illumination
- One push auto focus, white balance
- Programmable camera presets
- Remote control via PC using IRSoft

### Ordering information:

Order number	Description
<b>0PL650A</b>	<b>Motorized Precision Placement System PL 650</b> PL 650 module attachable to IR 650 and controlled via IRSoft

# Ersa IR/PL 650 XL

## The flexible Rework power-pack for the handling of extra large PCBs



1 5	2 5	3 5	4 5	5 5
6 2	7 2	8 1	9 3	10 3
11 2	12 2	13 1	14 3	15 3
16 4	17 4	18 4	19 4	20 4

1 - 20 = Heating element number  
1 - 5 = Zones

For today's rework operators working on large PCBs, one truth remains constant – the rework difficulty increases with the size of the PCB! From a profitability standpoint, reworking large PCBs represents a tremendous risk due to the very high PCB price. One failed rework procedure could destroy a PCB thereby losing the high material costs and follow-on profits!

PCBs up to 20" x 24" or 500 mm x 650 mm can now be safely and rapidly reworked using one of the industry's largest & most powerful bottom side heaters – an 8,000 W medium wavelength IR heater measuring 500 mm x 625 mm! Total system power is 9,200 W!

These extra powerful bottom & top heaters are necessary for large boards, especially for those which are thicker than 3 mm. Unless the entire

board area is efficiently preheated from the bottom, such boards show the tendency of bending and warping during the rework procedure. Divided into 5 separately controllable bottom side heating zones and 4 top side zones, the operator on the IR/PL 650 XL can individually set the heating power to each zone in order to find the optimal preheating conditions.

In addition to the total size & power of the bottom heater, an important factor is the position of the PCB over the bottom heater. The IR/PL 650 XL has a completely redesigned PCB holder table which exposes the entire PCB to the heater area. No matter where the component to be repaired is located on the board, the entire PCB is preheated! No cold spots means less warping!



The large PCB table design guarantees that all shapes of boards are carried in an optimal manner. Top- and bottom side support rails are easy to insert and adjustable to the actual rework task within minutes. The table includes a 45° butterfly mechanism to lift the entire PCB while it is inserted in the holder and thus provides easy access to the bottom side. The operator can easily attach thermo probes on the bottom side, position the support pins or carry out other “down under” operations like shielding heat sensitive components.

Finally, the IR/PL 650 XL has taken a completely new approach to cooling as the larger PCBs require a higher cooling volume. Similar to Ersas wave soldering machines, this rework machine has a new & highly efficient compressed air cooling system.

Using an air tube which extends the entire length of the bottom side heater, laminar flow cooling takes place via very fine air outlets. The air flow rate can be adjusted for a faster or slower cooling gradient.

#### Features IR/PL 650 XL

- Four programmable heating zones, top 1,200 W, 120 x 60 mm
- Five programmable heating zones, bottom 8,000 W, 625 x 500 mm
- PCB size up to 500 x 650 mm
- 5 channel temperature recording: 1 IRS sensor, 4 AccuTC thermocouples (K-type)
- DynamicIR & Multi True Closed Loop controlled selective reflow process with APR
- Laser pointer for component ID & PCB positioning
- Motorized reflow head with vacuum pipette
- Removable PCB fixing frame with top & bottom side center supports
- Integrated axial top & laminar bottom cooling fans
- Component handling vacuum pen
- RPC 650 camera swivel arm for process observation
- PC ready via USB
- Operation and monitoring via IRSoft

#### Ordering information:

Order number	Description
0IRPL650A-XL	Semiautomatic IR Rework System IR/PL 650 XL incl. RPC

# Ersa IR/PL 550

## The best selling Rework System

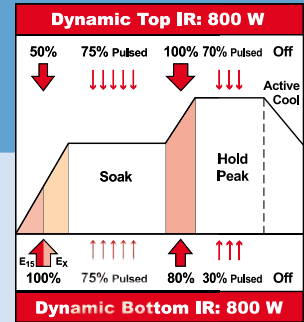

The IR/PL 550 is one of the best selling and most widespread rework systems in the world and offers the best cost/performance ratio. This system is designed for small to medium size PCBs and has proven itself to be the "Workhorse" in our rework product line.

The IR/PL 550 is a unit which offers the greatest flexibility for operators to best interact with their system in order to handle the most complex SMT and THT rework applications.

**The IR Rework system is broken down into four basic operational modules:**

- I. IR 550 Selective Reflow module**
- II. RPC 550 Camera module**
- III. PL550 Placement module**
- IV. IRSoft Software module**

### Recommended Accessories:

It is recommended to purchase the Process Cooling Fan with the IR 550. When the IR 550 is not used in combination with the PL 550, it is highly recommended to purchase the the X-Y Table. Additionally, it is helpful to purchase the Rework Starter Kit.

Special desoldering tools, such as the CHIP TOOL for small SMD removal and the X-TOOL for TH desoldering can be connected to the solder station integrated into this system.

For ordering details, please refer to the Ersa Tools catalog. A complete listing of all rework accessories can be found on pages 26 through 30.



# Ersa IR 550

## Unbeatable in price and performance!



SMT Vision Award:  
Best New Rework Product

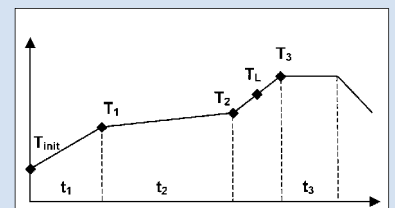

The IR 550 plus now affords greater profile flexibility with a flat peak

The IR 550 is the "Best Seller" in the Ersa rework line with thousands of systems sold. This module uses DynamicIR heating technology for fully automatic dynamic control of the top (800 W / 60 mm x 60 mm) and bottom (800 W / 135 mm x 260 mm) IR heaters.

Depending on board size, thermal mass of the substrate, and component size, the DynamicIR heaters (total of 1,600 W) guarantee that the required heat energy is delivered at the precise time and location in order to ensure that the component exactly follows the prescribed temperature profile.

Combined with the enhanced capability to run a flat peak, this revolutionary technology affords the lowest temperature deltas across the component, and greatly reduces PCB warpage.

### Features IR 550

- High performance IR heater, top (800 W)
- One programmable heating zone, bottom (800 W)
- 2 channel temperature recording: 1 IRS sensor, 1 AccuTC thermocouples (K-type)
- PCB size up to 250 x 320 mm
- DynamicIR & Closed Loop selective reflow process
- Laser pointer for component ID & PCB positioning
- Swivelling reflow head with vacuum pipette
- Integrated axial top cooling fan
- Integrated digital soldering station with soldering iron
- PC ready via USB
- Remote control via keypad or IRSoft

### Ordering information:

Order number	Description
<b>0IR550A</b>	<b>Rework System IR 550</b> incl. IRSoft, 1 x AccuTC and soldering station
<b>0IR5500-01</b>	<b>X-Y PCB Table</b> , (not required with PL 550)

# Ersa PL 550

## Precision Placement System with Reflow Process Camera

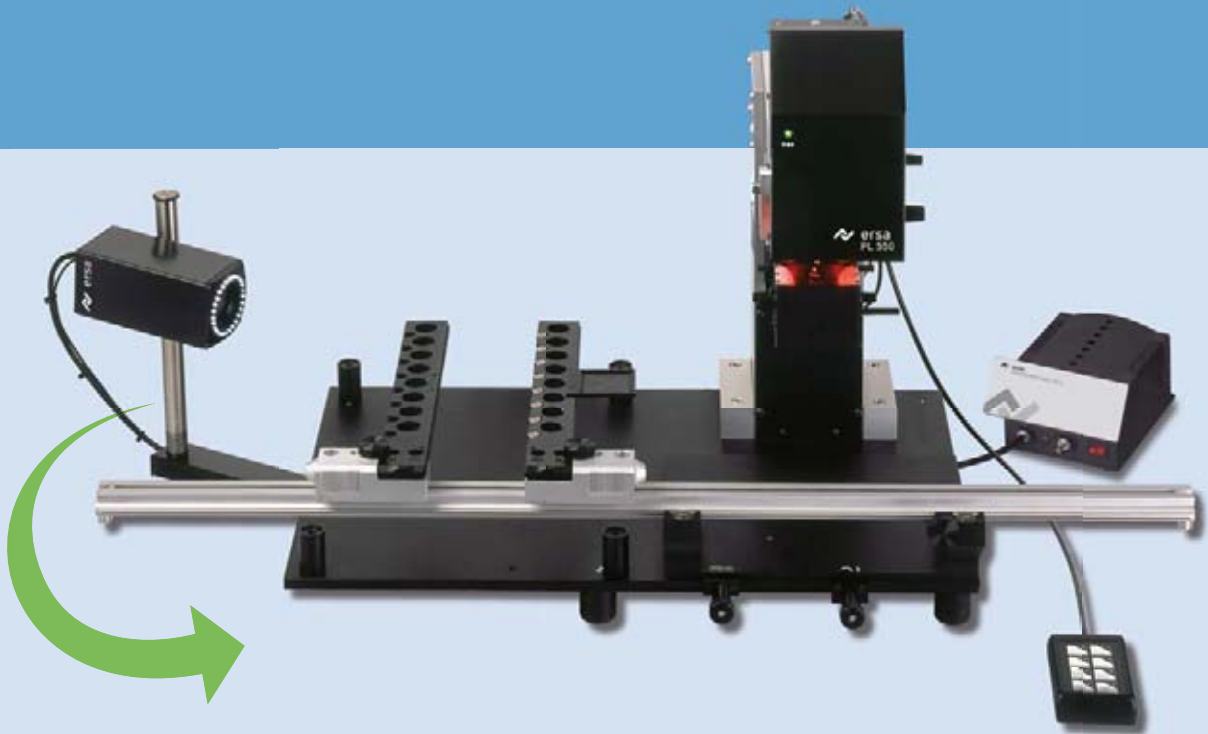

The PL 550 is a proven precision placement system designed for the largest range of components. A pressure triggered component placement head drops off the component at the same contact pressure (1.5 N) as an in-line Pick & Place machine. This Auto Component drop-off guarantees safe and precise results.

A high-resolution placement camera with motor zoom permits highly precise alignment of component connections to lands with up to 72x enlargement. The excellent image quality is supported by a high-contrast, separately controlled 2 colour LED lighting system from two sides.

### Recommended Accessories:

It is recommended to purchase the Split Optic Kit as well as additional placement nozzles. The RPC 550 module is a part of the PL 550 and uses a new high-power (up to 72x enlargement) motor zoom camera, a controllable LED ring lighting system, and an extremely robust, movable stand. The reflow process can be viewed real time from multiple angles and high magnification on even the smallest of components.

### Features PL 550 and RPC

- High-quality CCD cameras  
18x optical and 4x digital zoom
- Manual component handling  
from 1 x 1 mm to 40 x 40 mm in size
- "Auto Component Drop-Off" at 1.5 N  
(up to +/- 0.010 mm accuracy)
- Split optic cassette for large QFPs  
and BGAs (optional)
- Motorized component placement  
head
- Motorized zoom and focus
- Two side red/white LED illumination
- Dimmable LED ring light and swivel  
camera arm

### Ordering information:

Order number	Description
<b>0PL550A</b>	<b>Precision Placement System PL 550</b> with Reflow Process Camera
<b>0PL550AU</b>	<b>Precision Placement System PL 550</b> upgradeable with Reflow Process Camera
<b>0VSRPC-UKIT2</b>	<b>Reflow Process Camera Upgrade</b> for 0PL550AU

# Ersa RPC 500

## Stand Alone Reflow Process Camera

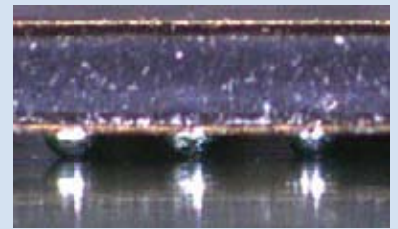

High magnification of Tessa CSP

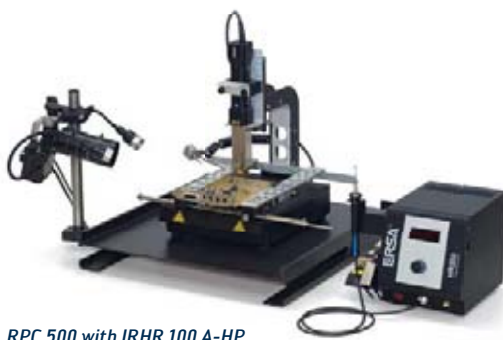

RPC 500 with IRHR 100 A-HP



RPC 500 with IR 550

The new RPC 500 unit offers rework process viewing at the lowest cost possible. The 70 x optical magnification, Macro Zoom Lens delivers highest quality and high magnification images of the finest applications.

Mounted on its bottom side, the 180° swivel arm carries the camera and provides maximum flexibility of process viewing angles.

This unit can be used in combination with the IR 550, the HR 100, the IRHP 100 and any other hand tools.

The camera is connected over an USB cable to the PC and the live image is visualised through IRSofT.

### Features RPC 500

- High-quality CMOS USB 2.0 camera
- 70x optical Macro Zoom Lens
- LED Dual Spot Lighting with flexible arms & variable intensity
- Free swivel arm (180°), stable stand
- Designed for IR 550 and HR 100



Ersa macro zoom

### Ordering information:

Order number	Description
0VSRPC500A-LE	Reflow Process Camera, complete

# Ersa HR 100 & IRHP 100

## Combined Hand Held & Benchtop Rework System



The new HR 100 uses Ersa's revolutionary and patented Hybrid Rework Technology for safe removal & replacement of small SMDs in a lead free environment! Safe, medium wave IR-radiation combined with a gentle hot air stream guarantees optimal energy transfer to the component.

The Hybrid Tool delivers smooth and homogeneous heat to lead free components sizing from 0201s to 20 x 20 mm SMDs and even larger.

Exchangeable Hybrid Adaptors focus 200 W of safe hybrid heating power onto the component while protecting neighbouring areas from blowing away adjacent chips.

The user friendly operation allows for even non experienced operators to handle the HR 100 safely and quickly.

Advanced operators using the HR/IRHP 100 complete system can not only set air volume and heating power levels, but they can also run & record profiles!

Ersa's ergonomically designed Hybrid Tool handle contains a positioning laser which helps the operator to focus the heat precisely throughout the entire process. Via the Mini-USB port, the HR 100 can be connected to Ersa's top of the line and well established rework software, Ersa IRSoft.



*Compact & easy to use*



Hybrid Rework System HR 100



IR Heating Plate IRHP 100

The HR 100 has been designed to be used with the IRHP 100, an 800 W IR-heating plate. This complete set provides powerful and safe IR bottom side heating as well as a Z-axis tool stand for the Hybrid Tool and an X-Y PCB board holder.

The K-Type thermocouple included monitors PCB temperature and even allows for a closed loop soldering process with ramp profiles.

**The HR/IRHP 100 fulfils all needs of a modern Rework System providing highest flexibility at the lowest cost!**

**Recommended Accessories:**

It is recommended to purchase the complete system (IRHR 100 A-HP) with an optional Process Cooling Fan. When using the HR 100 alone, it is recommended to purchase an AccuTC and Flexpoint TC holder for maximum rework safety. For a complete listing of all rework accessories, see pages 26 through 30.

**Ordering information:**

Order number	Description
<b>0IRHR100A</b>	<b>Hybrid Rework System HR 100</b> with 200 W Hybrid Tool, 3 Hybrid Adaptors, Adaptor changer, VacPen & Hybrid Tool holder
<b>0IRHR100A-HP</b>	<b>HR 100 &amp; IRHP 100</b> Hybrid Rework System complete with heating plate incl. stand with Hybrid Tool holder

**Features HR 100 & IRHP 100**

- Hybrid Tool with 200 W heating element
- Positioning laser and LED display in the Hybrid Tool handle
- Three exchangeable Hybrid adaptors
- Low Noise Rework Blower (below 40 db)
- Integrated vacuum pump & VacPen
- 2 channel temperature recording: 1 AccuTC thermocouples (K-type), 1 IRS sensor
- PC ready via USB
- Hybrid Tool holder with height adjust
- 800 W IR-heating plate with glass cover
- PCB board holder (250 x 290 mm)
- Control via rotary push button or IRSoft

# Ersa IRSoft

## User-friendly system control & process documentation for Ersa Rework Systems



*Rework temperature profile setting*

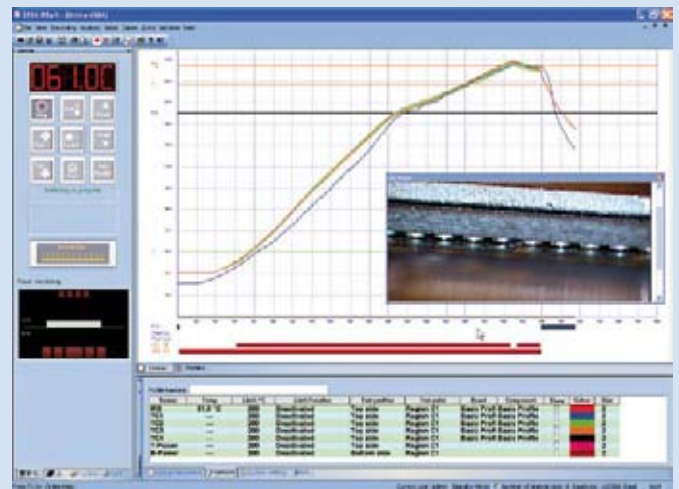

*Live temperature recording with real time video process window*

Ersa has rounded off its rework product platform from the hand held HR 100 all the way up to the IR/PL 650. IRSoft is an universal, system control, process documentation and process visualization software platform designed for use with all Ersa rework systems, from the smallest to the largest. In this manner, Ersa ensures operators an easy move between systems with hardly any learning curve required.

The IRSoft software package is available (see page 6) for the HR 600 with its additional automated functions.

### User-friendly Software

Probably the greatest advantage of the IRSoft rework software platform is that it was literally co-designed by our customers in the field. Today, with 15 years of rework experience and over 6,000 systems installed, we have continually added features and functions which were demanded by the market and have provided free updates to the existing user base. Fast and simple profiling, user level defined steps with access recognition & authorization and finally now the APR Automatic Process Repetition are all testimony to the continual advancement of this user oriented software platform.

The latest IRSoft offers new and clearly structured user administration options. A customized Log-In for beginner and advanced operators automatically opens only that rework system and those control options authorized for that specific individual. Additionally, the actual operating condition of all systems on-line is visualized in real time. All process steps are automatically recorded for process repeatability, documentation & traceability purposes.

# Ersa IRSoft Controls all modules



IR 650 & IR/PL 650 XL

IR 550

HR 100

RPC 650 module

PL 650 module

Customized library

This universal software concept ensures that operators can easily operate the different Ersa systems without additional training requirements.

## Controls all modules

The various functional modules contained in the Ersa rework systems can all be run with the IRSoft. In addition to the control of the reflow module with profile setting and temperature monitoring, the software runs the RPC and component placement modules. The Windows® explorer based, rework library databank can be customized by customer, application and or rework system.

### Features Ersa IRSoft

- Control software for IR/PL 650 & XL, IR/PL 550 and HR 100 (with IRHP 100)
- User-friendly interface with online help
- Visualization of all rework process data with up to 5 channel temperature recording
- Live process video window for RPC 550, RPC 650 and RPC 500
- Customized user admin rights & library for soldering & desoldering profiles
- Complete Process Documentation and Analysis
- Operating systems – Windows XP, Vista and 7
- All systems communicate over an ultra fast USB 2.0 cable included



Rework process visualization with Live Image Window

# Difficult Applications – No Problem!

## Ersa Rework Systems handle the most complex Rework applications

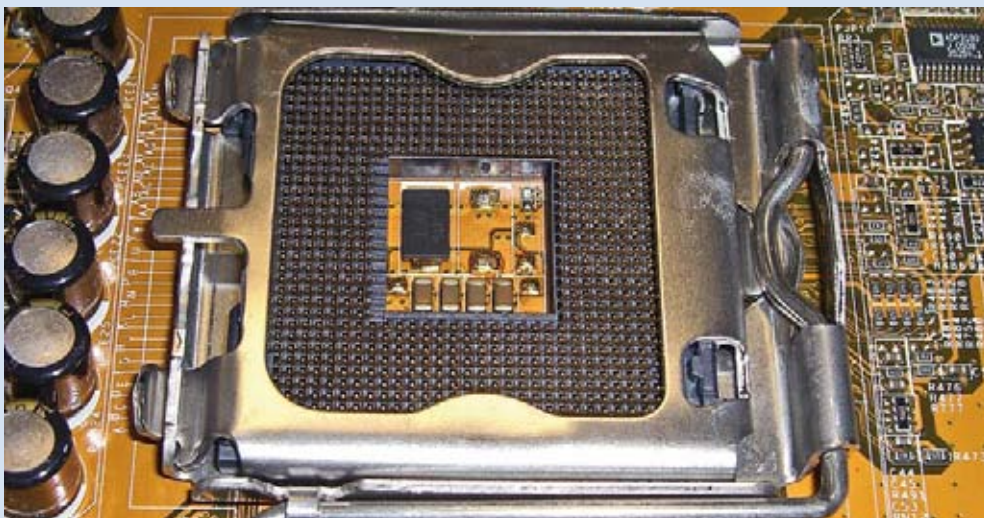

LGA 775 Processor Socket



BGA Plastic Socket



Ultra Heavy Mass PGA

The purchasing decision for today's rework equipment goes to the company that can GET THE JOB DONE!

Rework applications specialists at Ersa have proven the flexibility of our systems by handling applications where other units failed.

Some of the most difficult of these applications include: stacked BGA packages (RAM, DIMM module), top & bottom side shadowed BGAs, mobile phone shield and BGA rework, rework on aluminium composite boards, BGA desoldering with heat sink glued on component, LGA775 THT-socket exchange, BGA on flex circuit, reworkable epoxies, and large plastic BGA processor sockets just to name a few. Please look closely at the application picture gallery contained on these two pages to fully under-

stand the true versatility of the Ersa rework systems.

Finally, do not hesitate to contact Ersa directly for special rework applications assistance and training material.



*Ersa IR 550 is IPC's recommended BGA reballing system (Source IPC 7711)*



# Ersa Rework

## Takes care of all jobs!



*CSP, micro BGA*

*0201s, 0402s*



*FCBGA*



*PBGA on Aluminium Carrier*



*TO220 on Aluminium Carrier with HYBRID*



*CGA with Heat Sink*



*Plastic SMD Connector*

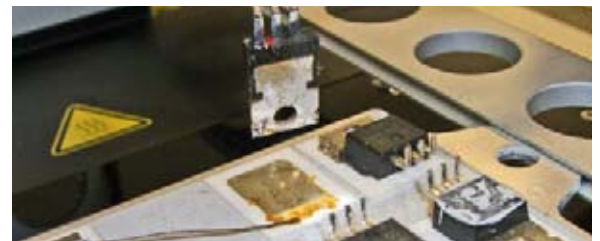

*TO220 on Aluminium Carrier with HYBRID*



*SOIC & Plastic SMT on Aluminium Carrier*



*Large Plastic SMD Connector*

Heavy mass aluminium carriers, metal plates & shields, ceramic substrates and even plastic components can be safely reworked with Ersa rework heating technology!

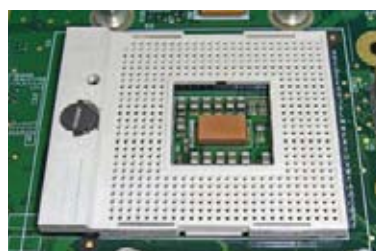

*BGA Processor Socket*



*BGA GPU*

# Accessories

As all rework operators know, the key to success comes down to two things: the right equipment and the right technique! Ersa provides all tools and accessories required to perform professional rework operations. On the following pages, the most frequently purchased and highly recom-

mended accessories are listed. Our years of rework experience with several thousand customers have allowed us to compile the most frequently purchased and most useful accessories. In each of the accessory tables below, we have included a column marked as "Starter Kit" which is the rec-

ommended Rework Starter Kit. Please consult our General Hand Tools Catalog for more items and do not hesitate to contact Ersa directly for custom tips and accessories or visit:

[www.ersa.com](http://www.ersa.com).



## Placement nozzles & suction cups

Order Number	Name	Description	Technical Data	HR 100 A	IR 550 A	IR 650 A	PL 550 A	PL 650 A	HR 600	Starter Kit
● 3HR600-06-023	Pipette, 1 mm	pick & place of smallest components	outer ø 1.0 mm						X	
● 3HR600-06-025	Pipette, 2 mm	pick & place of small components	outer ø 2.0 mm						X	
● 3HR600-06-022	Pipette, 4 mm	pick & place of medium size components	outer ø 4.0 mm						X	
● 3HR600-06-021	Pipette, 10 mm	pick & place of large components	outer ø 10 mm						X	
● OPL6500-13	Nozzle 0.8 mm	pick & place of smallest components	outer ø 0.8 mm					X		
● OPL6500-14	Nozzle 1.2 mm	pick & place of very small components	outer ø 1.2 mm					X		
● OPL6500-15	Nozzle 3 mm	pick & place of small components	outer ø 3.0 mm					X		
● OPL6500-16	Nozzle 4 mm	pick & place of medium size components	outer ø 4.0 mm					X		
● OPL6500-17	Nozzle 10 mm	pick & place of large components	outer ø 10 mm					X		
● OPL6500-18	Nozzle 10 mm/rubber lined	pick & place of heavy components	outer ø 10 mm, rubber lined					X		
● OPL500A-S00.8	Nozzle 0.8 mm ø	pick & place of smallest components	outer ø 0.8 mm				X			
● OPL500A-S01.2	Nozzle 1.2 mm ø	pick & place of very small components	outer ø 1.2 mm				X			
● OPL500A-S003	Nozzle 3 mm ø	pick & place of small components	outer ø 3.0 mm				X			
● OPL500A-S004	Nozzle 4 mm ø	pick & place of medium size components	outer ø 4.0 mm				X			
● OPL500A-S010	Nozzle 10 mm ø	pick & place of large components	outer ø 10 mm				X			
● OPL500A-S010-G	Nozzle 10 mm ø/rubber lined	pick & place of heavy components	outer ø 10 mm, rubber lined				X			
● OIR5500-40	MicroPickup Type 0510	lifting of smallest components, rigid	outer ø 1 mm, inner ø 0.5 mm, brass	X	X	X			X	
● OIR5500-41	MicroPickup Type 1020	lifting of small components, rigid	outer ø 2 mm, inner ø 1 mm, brass	X	X	X			X	
● OIR5500-44	Suction adaptor small	adaptor for small suction cups	for cups 2 and 3.5 mm, brass	X	X	X			X	
● OIR5500-45	Suction adaptor large	adaptor for large suction cups	for cups 5 and 8 mm, stainless steel	X	X	X			X	
● OIR4520-01	Silicone suction cup 8 mm	lifting of large components, flexible	outer ø 8 mm, silicone	X	X	X			X	3
● OIR4520-02	Silicone suction cup 5 mm	lifting of medium size components, flexible	outer ø 5 mm, silicone	X	X	X			X	3
● OIR4520-03	Silicone suction cup 2 mm	lifting of very small components, flexible	outer ø 2 mm, silicone	X	X	X			X	
● OIR4520-04	Viton® suction cup 8 mm	lifting of large components, flexible	outer ø 8 mm, Viton®, long life	X	X	X			X	
● OIR4520-05	Viton® suction cup 5 mm	lifting of medium size components, flexible	outer ø 5 mm, Viton®, long life	X	X	X			X	
● OIR4520-06	Viton® suction cup 3.5 mm	lifting of small components, flexible	outer ø 3.5 mm, Viton®, long life	X	X	X			X	

Viton® is a registered trademark of Dupont Dow Elastomes



## Temperature sensors

Order Number	Name	Description	Technical Data	HR 100 A	IR 550 A	IR 650 A	PL 550 A	PL 650 A	HR 600	Starter Kit
● <b>0IR6500-01</b>	AccuTC sensor with fixture	thermocouple with metallic fixture	Ni-Cr-Ni sheathed thermocouple, ø 0.5 mm	X	X	X				
● <b>0IR6500-37</b>	AccuTC sensor with out fixture	thermocouple with out metallic fixture	Ni-Cr-Ni sheathed thermocouple, ø 0.5 mm	X	X	X			X	
● <b>0IR4510-02</b>	Thermo couple wire K-type	temperature measurement	Ni-Cr-Ni wire, thermo-plug	X	X	X			X	
● <b>0IR5500-35</b>	TC holder Flexpoint	adjustable holder for AccuTC	length 210 mm	X	X	X	X		X	
● <b>0IR5500-36</b>	Flexpoint extension	Flexpoint extension	length 210 mm	X	X	X	X		X	
● <b>0HR640</b>	TC holder for HR 600	adjustable holder for AccuTC	length approx. 170 mm						X	



## Additional equipment

Order Number	Name	Description	Technical Data	HR 100 A	IR 550 A	IR 650 A	PL 550 A	PL 650 A	HR 600	Starter Kit
● <b>0IR5500-13</b>	Cooling fan with deflector hood	cooling of PBCs after rework	air volume: 160 cbm/h	X	X					
● <b>0IR5500-43</b>	Deflector hood for Cooling fan	direct airflow to the side	aluminium	X	X					
● <b>0PL500A-SPC</b>	Split optic cassette for PL 550	magnified view of component corners	for components with diagonal of 21 - 50 mm				X			
● <b>0PL6500-11</b>	Split optic cassette for PL 650	magnified view of component corners	for components with diagonal of 15 - 55 mm					X		
● <b>0PL6500-12</b>	Centering station for PL 650	centering of components	to mount on PL 650					X		
● <b>0DTM100</b>	Digital temperature measuring device	temperature measurement	for K-Typ thermocouples, battery driven	X	X	X			X	
● <b>0IR5500-33</b>	ROBAX® glass plate for IR 550	glass plate cover for heating elements	ROBAX® glass plate		X					

# Accessories



## Consumable items

Order Number	Name	Description	Technical Data	HR 100 A	IR 550 A	IR 650 A	PL 550 A	PL 650 A	HR 600	Starter Kit
010MM0250LF02	Solder wire	Solder wire, Sn96.5Ag3.0Cu0.5	1 mm diameter, 250 grams		X	X				1
0WICK NC 2.2	No Clean Solder Wick	remove solder	width 2.2 mm, length 1.5 m		X	X				
0WICK NC 2.7	No Clean Solder Wick	remove solder	width 2.7 mm, length 1.5 m		X	X				1
4FMJF8001-PEN	Flux Pen, Interflux IF8001	flux & applicator	with fiberglass brush, refillable, 7 ml	X	X	X				
4FMJF6000-PEN	Flux Pen, Interflux IF6000	flux & applicator for lead free applications	with fiberglass brush, refillable, 7 ml	X	X	X				1
4FMJF8300-005	Flux Gel	flux for e.g. solderwell process	Dispensing cartridge & needle, 5 ml	X	X	X			X	1
0IR4500-40	Heat Shielding Tape	heat protection of adjacent components	width 25 mm, length 1 m, Aluminium	X	X	X			X	1
0IR4500-07	Capton Tape	heat resistant tape	width 25 mm, length 10 m	X	X	X			X	1
0IR6500-46	PTFE-Glass-Cloth-Tape	heat resistant tape to improve IRS reading on reflective surfaces	width 40 mm, length 5 m	X	X	X	X	X	X	
0TR01/SB	Tip-Reactivator	reactivate soldering tips	chemical paste, 15 g can		X	X				1
0TR02/SB	Tip-Reactivator	reactivate soldering tips (new: without abrasive)	chemical paste, 30 g can		X	X				
0FR200	Flux-Remover	remove flux and clean PCB	Spray can with brush, 200 ml	X	X	X			X	1

Eine komplette Liste von Lötzinn und Entlötlitzen finden Sie im Ersa Werkzeugkatalog, oder besuchen Sie uns im Internet unter [www.ersa.de](http://www.ersa.de)

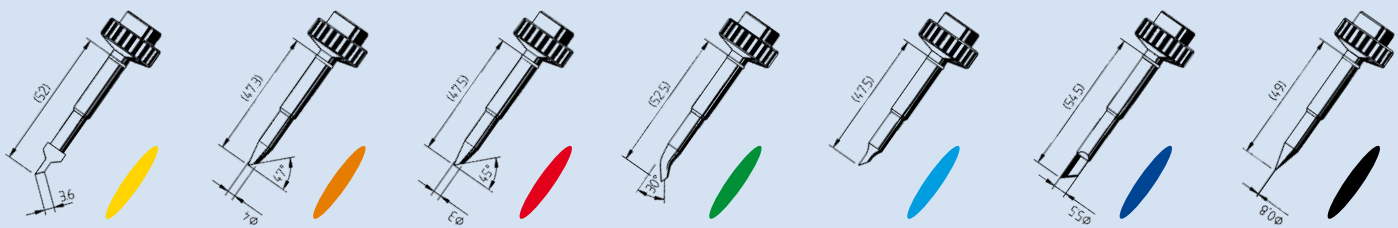

## Solder tips

Order Number	Name	Description	Technical Data	HR 100 A	IR 550 A	IR 650 A	PL 550 A	PL 650 A	Starter Kit
0612ZD/SB	Wick Tip	remove solder with wick	10.5 x 3.6 mm		X	X			1
0612WDLF/SB	Solder Tip, 4 mm, angle faced	remove solder	4 mm, 45°		X	X			1
0612ND/SB	Solder Tip, 3 mm angle faced	remove solder	3 mm, 45°		X	X			
0612HD/SB	Solder Tip, Solderwell	soldering QFP, solder well process, remove bridges	2.5 mm concave well		X	X			1
0612TW/SB	Solder Tip, Techwell	apply solder	3 mm, concave well		X	X			
0612MD/SB	Solder Tip, PLCC Blade	PLCC installation	1.5 mm		X	X			
0612UDLF/SB	Solder Tip, pencil point	fine SMD soldering	0.8 mm		X	X			1



## PCB Tables & Holders

Order Number	Name	Description	Technical Data	HR 100 A	IR 550 A	IR 650 A	PL 550 A	PL 650 A	HR 600	Starter Kit
● <b>0IR5500-01</b>	PCB X-Y table	fixture for PCBs or PCB holders	recommended PCB size 280 x 390 mm	X	X	X				
● <b>0PL500A-LP01</b>	support for PCB holder	support & fixture to prevent PCB warpage	4 pcs, length 250 mm each, stainless steel	X	X		X			
● <b>0PH360</b>	PCB holder	fixture and support of medium size PCBs	recommended PCB size 270 x 365 mm		X	X	X	X		
● <b>0PH100</b>	PCB holder	fixture of small PCBs	recommended PCB size 170 x 170 mm	X	X	X	X	X		
● <b>0IR6500-16</b>	PCB holder	fixture and support of large PCBs	recommended PCB size 460 x 560 mm			X		X		
● <b>0IR6500-17</b>	PCB holder set	fixture of odd shaped PCBs	4 pcs, 30 mm adjustable length per clamp, aluminium	X	X	X	X	X		
● <b>3HR600-08</b>	PCB holder HR 600	fixture and support of PBCs	recommended PCB size 285 x 390 mm						X	

Additional rails, downholders ... etc. for all PCB holders upon request.

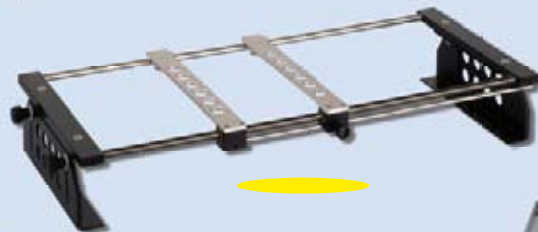

# Accessories

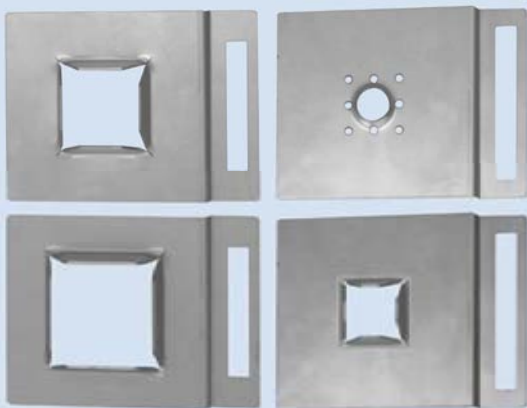

## Baffles HR 600

Order Number	Name
<b>0HR620-001</b>	Baffle 40 x 40 mm
<b>0HR620-002</b>	Baffle 30 x 30 mm
<b>0HR620-003</b>	Baffle 20 x 20 mm
<b>0HR620-004</b>	Baffle ø 10 mm

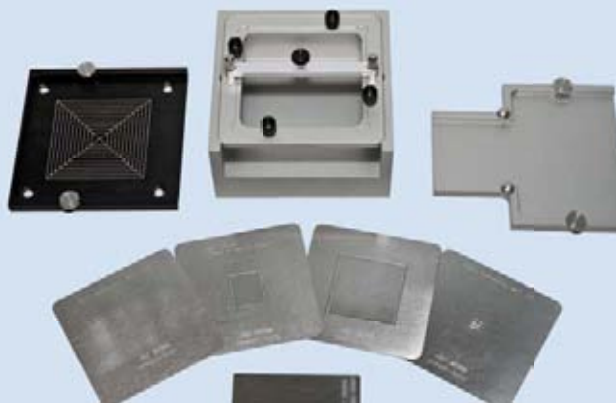

## Dip&Print Station

Order Number	Name
<b>0PR100-D001</b>	Dipping stencil 40 x 40 / 300 µm
<b>0PR100-D002</b>	Dipping stencil 20 x 20 / 150 µm
<b>0PR100-D003</b>	Dipping stencil 20 x 20 / 100 µm
<b>0PR100-D004</b>	Dipping stencil 40 x 40 / 100 µm
<b>0PR100-PL550</b>	Frame fixation PL 550
<b>0PR100-PL650</b>	Frame fixation PL 650
<b>0PR100-R001</b>	Squeegee 70 x 25 mm, 0.3 mm thick
<b>0PR100-S001</b>	Printing stencil, type 1, BGA 225
<b>0PR100-S002</b>	Printing stencil, type 2, MLF 32
<b>0PR100-S003</b>	Printing stencil, type 2, QFN 20

### NOTE:

Ersa's customer service department assists its customers in selecting suitable fluxes and solder pastes for the Dip-in and the printing process. For example, Interflux, a manufacturer of fluxes and solder pastes, recommends its product "µ-dlFe7" as dip-in solder paste, and flux gel "IF 8300" for this process.

In order to fabricate a printing stencil for a certain product, we would require a datasheet showing the exact dimension of the body as well as the position of the pins. Depending on the complexity of the stencil, Ersa will issue a suitable proposal.

# Inspection

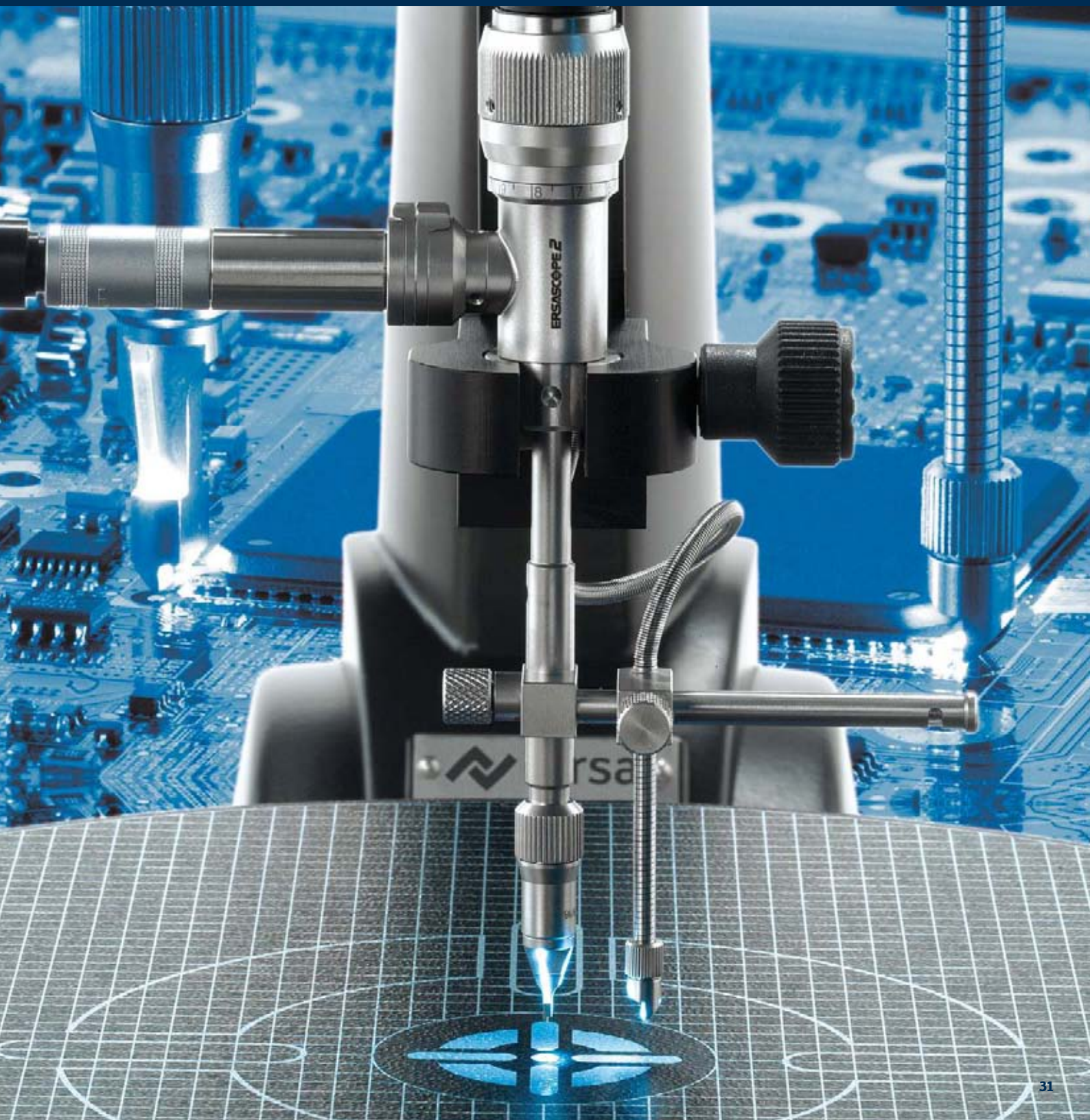

# Proper inspection can save money!

## Industry standards like IPC & experts alike promote hidden solder joint inspection

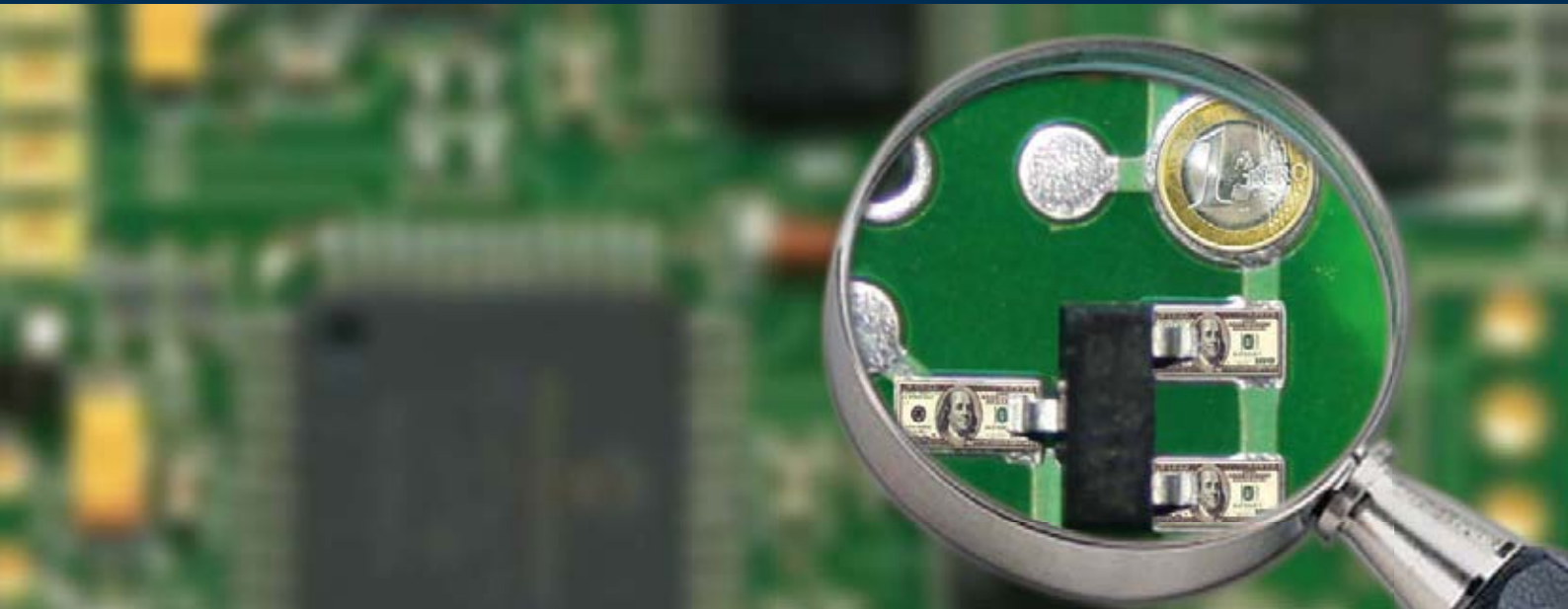

Industry experts rely on endoscopic inspection technology. The IPC standard IPC-7095B (March 2008) recommends the use of endoscopes for BGA inspection.

The lead free process will lead to new problems and will require an improved inspection process using ERSASCOPE technology. The defects shown in the images below cannot be detected

with standard microscopes. If undetected, such problems will result in the improper qualification of the lead free process.

The award winning ERSASCOPE is a patented, endoscope based system specifically designed for hidden solder joint inspection under components like BGAs, CSPs and Flip Chips.

To See is to Survive – Only by being capable of seeing all potential problems in your process, will you be able to react, in order to correct those problems, to assure quality and TO SAVE MONEY!



*Flux residue under BGA*

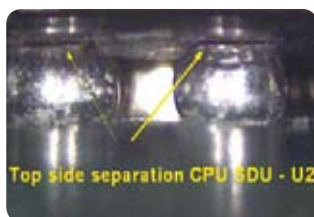

*Top side delamination of BGA*



*PGA: insufficient hole fill*

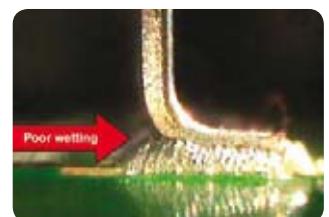

*PQFP: missing interior heel fillet*



# ERSASCOPE

## Best in class Inspection Technology

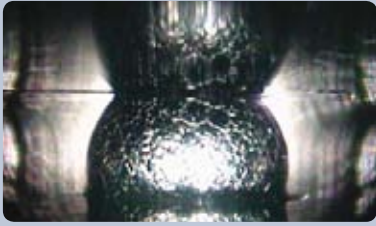

See demovideo: [www.ersascope.com](http://www.ersascope.com)



US patent no. US 6,580501  
EU patent no. EP 11 23 525



**1999 Dr. Rudolf-Eberle,**  
Innovation Prize, Germany

**1999 Most Innovative Product,**  
ELENEX Australia

**2000 Best Product in Show,**  
Component & Electronic, Sweden

**2000 EP&P Excellence Award,**  
Nepcon, USA

**2000 EP&P Grand Award,**  
Nepcon, USA

**2000 SMT Vision Award,**  
Best New Product, Inspection, Apex, USA

# ERSASCOPE 1 vs. ERSASCOPE 2

## Which system is best for which inspection application?



### **Best in class optical inspection technology for inspecting underneath components**

for not only BGA, but also for the hidden, interior joints on SMD and TH components.

The award winning & patented original ERSASCOPE technology has been further developed in order to meet today's lead free and low component profile challenges.

The ERSASCOPE 2 is currently the ONLY inspection system in the world offering exchangeable optical heads for Flip Chip, CSP, BGA and Q201 optical inspection.

The ERSASCOPE 1 offers a cost effective optical inspection solution in accordance with the new IPC Inspection Standards (see IPC -7095B)



*ERSASCOPE 1  
fixed optics  
for BGAs;*



*ERSASCOPE 2  
Exchangeable  
optics for CSPs*



*The ERSASCOPE XL  
system with retraction  
unit and XL-table for  
the inspection of over-  
sized assemblies.*

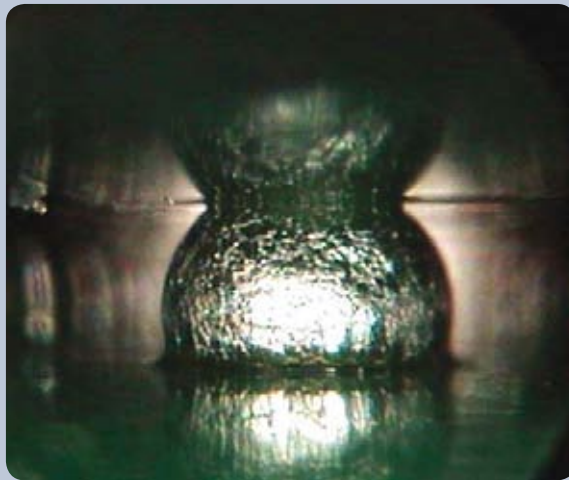

ERSASCOPE 1 image of BGA (gap ~ 300 μm)

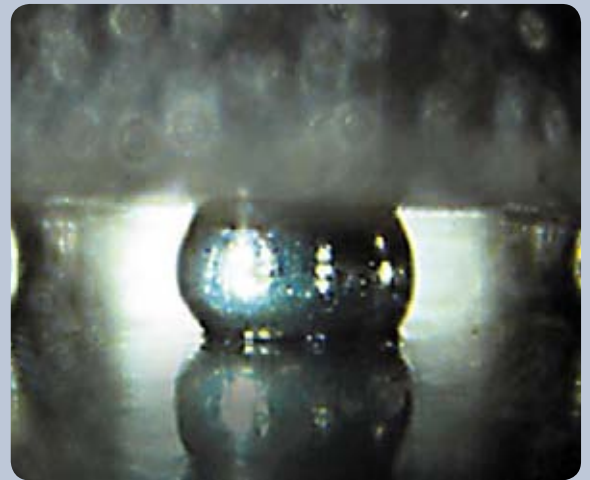

ERSASCOPE 2 image of Flip Chip (gap ~ 30 μm)

Whereby both ERSASCOPE systems are fundamentally similar in their capabilities, they differ technically in the following functional areas listed in the technical comparison table below.

When considering inspection applications, the two ERSASCOPE systems differ with respect to the standoff height of the component to be

inspected and the density of the PCB. The ERSASCOPE 1, 90° lens for example has a footprint 1.5 x 4.5 mm, a magnification up to 400x\* and a typical inspection gap of ~ 300 μm. The Flip Chip optical lens of the ERSASCOPE 2, on the other hand, has a footprint of only 0.6 x 4.0 mm, a magnification up to 700x\* and a typical inspection gap of ~ 30 μm.

Low standoff components such as CSPs and Flip Chips are thus better inspected with the ERSASCOPE 2 system.

\*20" monitor, 1600 x 1200 pixel resolution, no digital zoom

### Technical comparison:

Part	ERSASCOPE 1	ERSASCOPE 2
Optic	Endoscope with fixed integrated lens	Endoscope with exchangeable lenses
Camera	Digital USB Camera	High resolution CCD, 1.3 megapixel
Light Source	Halogen	Metal halide
Table	x-y	x-y rotation
Software	ImageDoc	ImageDoc

# ERSASCOPE 2

## The world's only optical inspection system for Flip Chips & CSPs



The ERSASCOPE 2 comes standard with a MHLS Metal Halide Light Source. The long life metal halide light bulb offers a much cleaner, & brighter white light compared to other systems. A mechanical iris on the MHLS station regulates the light quantity without changing the temperature or colour during dimming. Two mechanical irises on the optic carrier allow for individual & separate continuously variable dimming (0 to 100 %) of the front & back lights. Also standard is a newly designed fibre optic light brush made up of individual fibres (0.050 mm diameter) which can be inserted under most area array packages for optimal lighting during inspection.

### Optical carrier

The ERSASCOPE 2 optical carrier is a highly advanced, endoscope based system offering a rapid exchange of the 3 robust optical heads (lenses) as well as precise image focussing and superior light management. Value added features include:

- Fibre optic front & back lights with mechanical iris adjustable from 0 to 100 %
- Swing out & fixture mechanism of backlight arm
- Connection & fastening of the 3 optical heads
- Focus ring with measurement scale
- "One Click" interface for fibre optic light cable



*Easy to change & robust optical heads offer the greatest inspection flexibility*

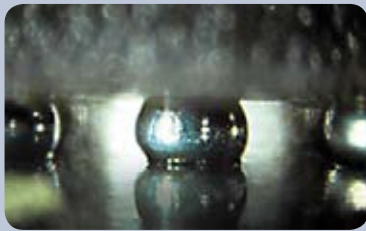
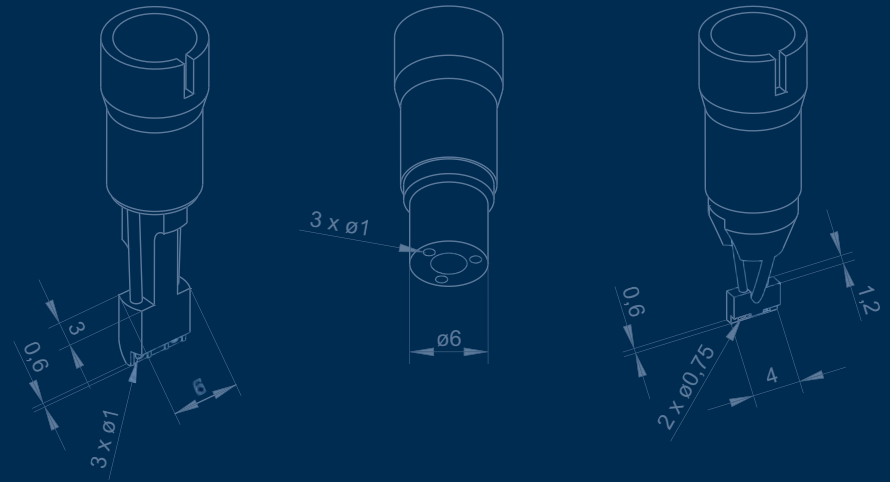

90° Flip Chip head

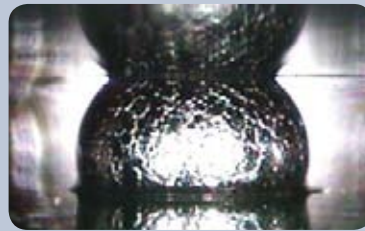

90° SMD & BGA head

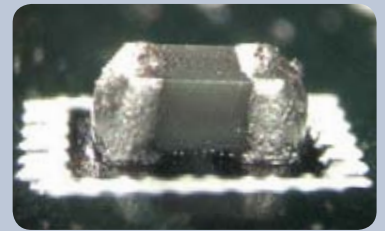

0° Microscope head

## Flip Chip 90° lens

The revolutionary Flip Chip optical lens has the smallest foot print in the industry (0.6 x 4.0 mm) and has been specifically designed for use on densely packed PCBs. The ERSASCOPE 2 Flip Chip head's aperture height is so low that it is now possible with a magnification up to 700x to inspect even a typical gap of ~ 30 µm. The critical top side Flip Chip joint, never before seen by any BGA optical inspection equipment on the market, is now visible!

### Ordering information:

Order number	Description
0VSSC600	Inspection system ERSASCOPE 2, complete
0VSSE200-90K	90° optical lens
0VSSE200-FCK	Flip Chip optical lens
0VSSE200-0K	0° optical lens

## BGA 90° lens

The ERSASCOPE 2 BGA lens provides a high resolution, 90° viewing angle under the component. This light sensitive optical lens offers a 425x magnification in a typical inspection gap of ~ 300 µm and a footprint of 3 x 6 mm. The digital zoom and focus distance of 50 mm makes it possible to inspect the interior joints underneath the BGA component!

## “Look down”, 0° lens

The wide angle, 0° optical lens offers viewing similar to a microscope. The integrated fibre optic lighting perfectly illuminates and magnifies up to 250x for high-contrast surface and via hole inspection.

### Features ERSASCOPE 2

- High Resolution USB 2.0-CCD Camera
- Flip Chip optical lens (700x mag., gap ~ 30 µm)
- BGA optical lens (425x mag., approx. 300 µm)
- Wide Angle 0° “Look down” optical lens (250x)
- Optional high-quality Macro Zoom Optic (70x) with fiber ring light
- Long life Metal Halide light source
- Light management: fiber optic front and back lights with mechanical iris, fiber optic light brush and -flat brush, goose neck
- Tripod and table with a total of 7 movable axis' for the the optics and the board
- ImageDoc Basic or EXP Software for both Beginner & Advanced Operators
- Large Database of Problems & Solutions
- Advanced Recording, Measurement & Reporting Functions
- “Plug & Play” Set Up

# Light, Camera and Action!

## Best in class Inspection productivity with highest quality Images

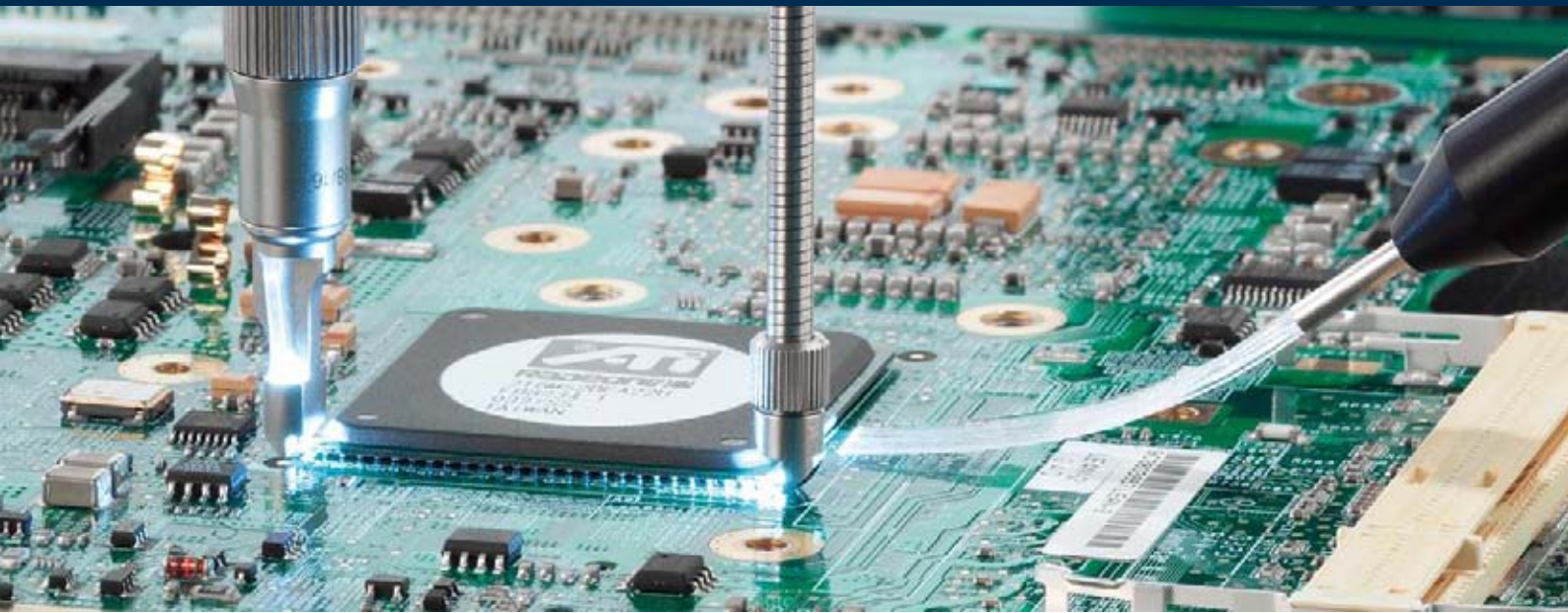

*Optimal component lighting is essential for a quality inspection process*

### Superior Light Management

The ERSASCOPE 2 inspection system comes standard with the MHLS Metal Halide Light Source. The metal halide light bulb offers a much cleaner, crisper and brighter "white" light compared to other systems. A mechanical iris on the MHLS station regulates the light quantity without changing the temperature or colour of the light during dimming.

Also standard is a newly designed fibre optic light brush. This new light brush is made up of individual fibres (0.050 mm diameter) which can be inserted under most area array packages and mechanically dimmed for optimal lighting during inspection.

Finally, the metal halide light bulbs have an average expected lifetime of over 2,000 hours. This represents a 400 % lifetime improvement over the previous light source!

Furthermore, all fibre optic light cables have a mechanical iris. Two mechanical irises on the optic carrier allow for individual & separate continuously variable dimming adjustment from 0 to 100 % of the front & back lights.



*Mechanical irises control both the front & back lights for perfect lighting*



*7 axes of movement  
of the ERSASCOPE  
optic positioning  
guarantees maxi-  
mum flexibility &  
productivity*



### **High Resolution, Light Sensitive USB 2.0 Camera**

In addition to optimal light management, image quality depends not only on precision optics, but also on high-quality camera technology. The high-resolution and highly light sensitive Ersa USB 2.0 camera has 1.3 megapixels and delivers images of highest detail & perfect contrast. Even the smallest object details can be captured, digitally enhanced and used for quality assurance & documentation purposes.

### **ERSASCOPE Inspection Stand & Table**

The ERSASCOPE stand and inspection table offer the most accurate BGA inspection in the fastest cycle time when compared to all competitive systems on the market. The greatest flexibility with a total of 7 axes of movement of the ERSASCOPE optic

positioning is guaranteed: optics pan positions every 90°, unlimited table rotation, unlimited camera rotation, free tilting of optic between +/- 90° with zero degree lock position, X-Y-Z adjustment in micrometer range.

*Mechanical iris  
controls the  
removable fibre  
light fan for ad-  
ditional lighting*



# ERSASCOPE 1

The award winning & patented original

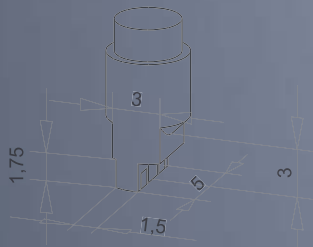

## Optics

The patented ERSASCOPE is the world's first optical inspection system which allows for non-destructive manual inspection of BGAs.

Today over 3,000 users worldwide are benefiting from finding defects that would have otherwise gone undetected by other inspection methods.

The ERSASCOPE 1 optic is a specially designed endoscope with an integrated fibre optic system, focus ring & adjustable back light; a footprint of 1.5 x 4.5 mm; a magnification up to 400x and a typical inspection gap of ~ 300 µm.

*High magnification & viewing angles from 0 to 90° offer maximum inspection flexibility*

## Camera

The digital camera with USB 2.0 interface uses CMOS technology offering optimal light sensitivity and resolution. The halogen light source supplies optimal light to both the ERSASCOPE 1 optic as well as the flexible gooseneck lighting which is included standard with the system.

## Light Management

Two light outlets at the ERSASCOPE optical system & a third flexible arm light ensure superb light distribution both on the PCB surface and beneath the component.

Via mechanical coupling of the back-light with the inspection head, the illumination remains uniform during movement along the component thus





*Integrated front & back lighting allows for optimal illumination of the hidden joints underneath the component*

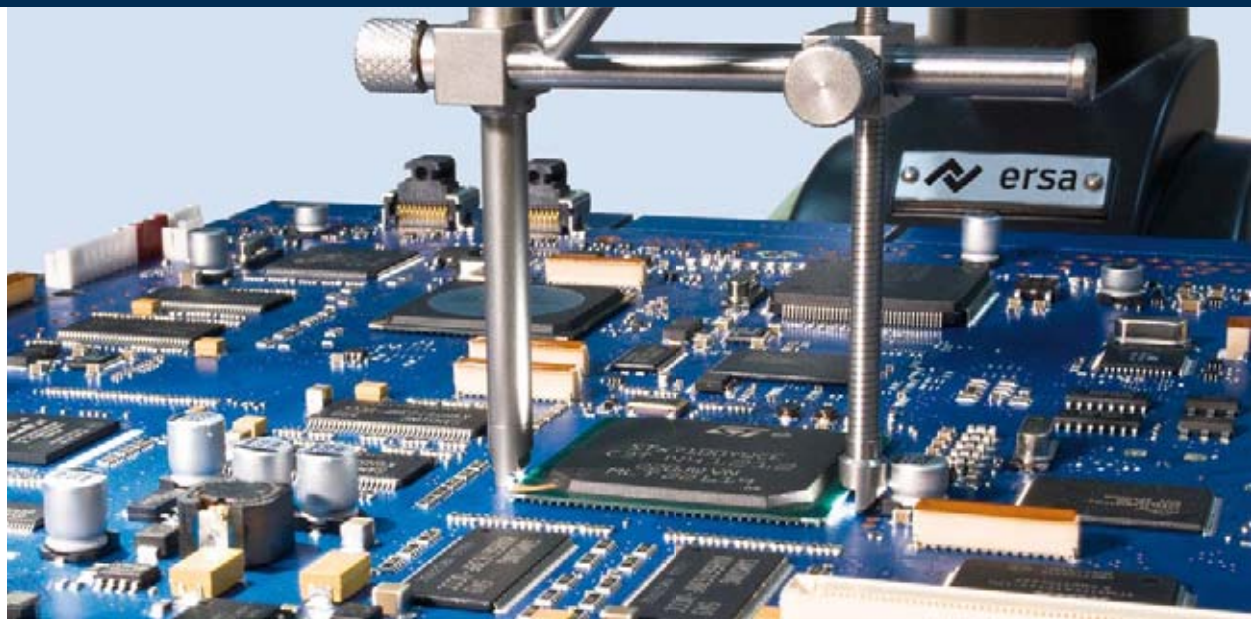

allowing for the fastest BGA inspection of any system on the market.

The Ersa halogen, "cold" light source was specifically designed for ERSASCOPE industrial endoscopy and image processing. Continuous dimming from 0 to 100 % ensures an optimal light control in areas where an exact lighting adjustment is required such as by hidden joint inspection underneath BGAs.

### Table & Stand

The multifunctional ERSASCOPE inspection stand includes Z-axis course and fine adjustment of the scope and offers a total of 6 axes of movement for the scope. It is thus possible to view an object at almost any angle! The X-Y PCB table has two movement wheels for course and fine movement of the PCB during inspection.

### Software

Image processing and documentation software goes hand in hand with today's inspection requirements. The ERSASCOPE 1 comes standard with ImageDoc Basic inspection software.

### Features ERSASCOPE 1

- High resolution USB 2.0-CMOS camera
- High quality BGA optical lens (400x mag., approx. 300 µm)
- Option high-quality Macro Zoom Optics (70x) with glass fiber ring light
- Long life Metal Halide light source
- Light management with flexible arm and optional fiber optic light brush & fan; mechanical iris adapter
- Stand & table with 6 axes of movement of optics & PCB
- ImageDoc Basic or EXP Software for both Beginner & Advanced Operators
- Large Database of Problems & Solutions
- Advanced Recording, Measurement & Reporting Functions
- "Plug & Play" set up

### Ordering information

Order number	Description
0VSSC070	Inspection System ERSASCOPE 1, complete

# Ersa MOBILE SCOPE

## Mobile optical inspection system for electronics production



X-Y table



Foot switch for capturing image



Focusing stand



LED brush light stand



Desktop holder for Ersa MOBILE SCOPE



Focusing stand with Ersa MOBILE SCOPE

The Ersa MOBILE SCOPE is a compact and handy, portable video microscope to inspect solder joints in electronic production environments. The device has been designed for optical inspection and digital image recording including measurements of solder joints on Ball Grid Array (BGA),  $\mu$ BGA, CSP and Flip-Chip packages.

The Ersa MOBILE SCOPE is suitable to inspect PCB lands, solder paste prints or in general for the optical inspection of components on printed circuit boards in Surface Mount Technology (SMT) or in Trough Hole Technology (THT). The device can be used in quality control, production, laboratories or R&D departments.

The compact Ersa MOBILE SCOPE connects with a PC or any portable computer via an USB interface and is ready for operation within minutes in any location.

By means of the high-quality BGA optical head, components with hidden solder joints can easily be inspected, a Macro-Zoom lens allows topview surface inspection in various magnifications. Both optical heads are plugged onto the high-resolution digital color camera hand piece with a „Quick Snap“ connection. Changing the optical heads in accordance to the inspection task is a matter of seconds.

Inspection  
of a CSP



Long-life and very bright controllable LED lights are integrated in both optical heads and provide optimal illumination of the solder joints. In BGA inspection an additional LED brush light is essential for backlight illumination or to light up very hidden and hard to reach areas. Soldering errors can be detected quickly and easily with the Ersca MOBILE SCOPE.

The included and established ImageDoc inspection software not only displays the live images but also offers the operator various possibilities for documentation and analysis of the inspection results.

Extensive accessories allow the operator to compose his individual Ersca MOBILE SCOPE inspection system according to his needs.

The practical aluminium case for the Ersca MOBILE SCOPE offers safe storage of the inspection items and transportation of the system to any location wherever it is needed.

#### Features Ersca MOBILE SCOPE

- High resolution USB camera
- High quality BGA optical lens (180x)
- Optional 0° optical lens (80x)
- Integrated, adjustable LED lighting
- Optional LED glass fiber lighting
- Stands and other accessories
- ImageDoc Basic or EXP Software for both Beginner & Advanced Operators
- Large Database of Problems & Solutions
- Mobile application

#### Ordering information:

Order number	Description
0VSCA060	Basic camera unit
0VSSC060VK1	Sale set 1, for details see page 50
0VSSC060VK2	Sale set 2, for details see page 50
0VSSC060VK3	Sale set 3, for details see page 50

QFP solder joints –  
taken with the Ersca  
MOBILE SCOPE  
Macro Zoom Lens



# Software Ersas ImageDoc

## Inspection software designed for inspectors, documented by experts!

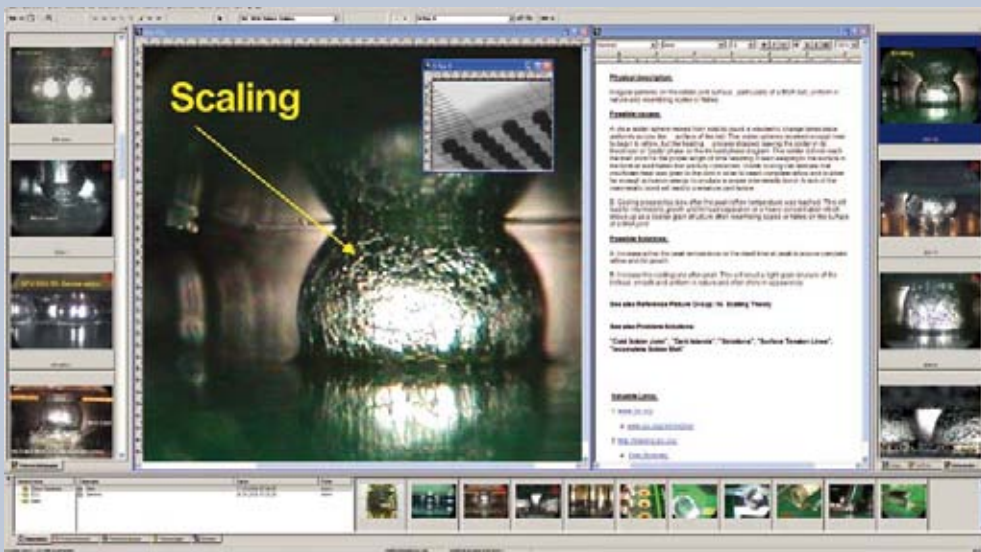

*Reference Picture Databank  
Live image with "good/bad" reference  
images assists operator*



*Database &  
reporting modules  
store process  
& FA info*

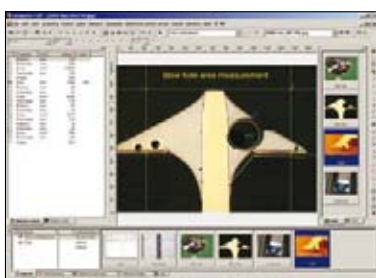

*Extensive  
measurement  
control and  
labelling  
functions*

The ImageDoc software platform was designed to accompany, assist and document the inspection process. Based on the four fundamental principles of Inspect, Classify, Analyse and Document, this software concept was designed for QA inspectors! Lead free implementation will require a complete re-training of how operators classify solder joint quality. The days of "If the solder joint looks good, it most likely is good!" are over! The ERSASCOPE software guided inspection approach will greatly assist in getting operators properly trained for lead free.

Ersa ImageDoc software guides the operator through the critical and time consuming process of determining whether a defect exists, and then directs the operator where to look in the process in order to correct the problem! Inspection subjectivity is reduced, problems are solved quicker

and valuable process information is documented for future use! The included database can be modified and extended by the user at any time. This allows adding own reference pictures (with good/bad marking) and problem/solution hints.

### Features ImageDoc Basic

- Live & still picture window for documentation & control
- Image database of known examples of "good" & "bad" solder joints for evaluation purposes
- Reference pictures
- Database with soldering process problems / suggested solutions from Ersa, Fraunhofer and the industry
- Measurement & automatic measure control function/calibration
- Image processing & labelling
- Basic reporting/ e-mail out of application
- Plug & Play set-up

# Still sharper views at even more depth ImageDoc EXP with new image processing functions

*“Focus Fusion”  
View of QFP  
solder joints*

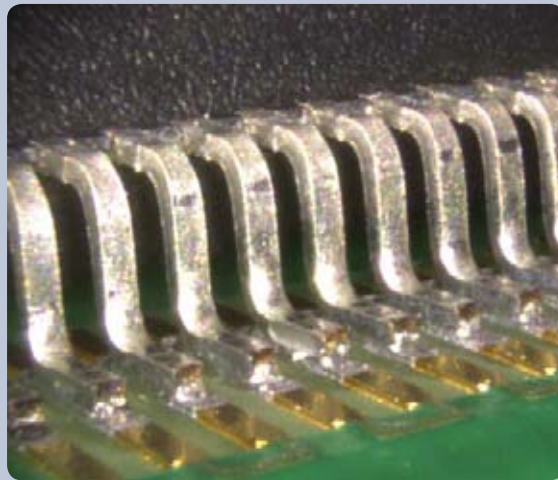

*“Focus Fusion”  
View of a BGA  
printed with solder  
– after placement*

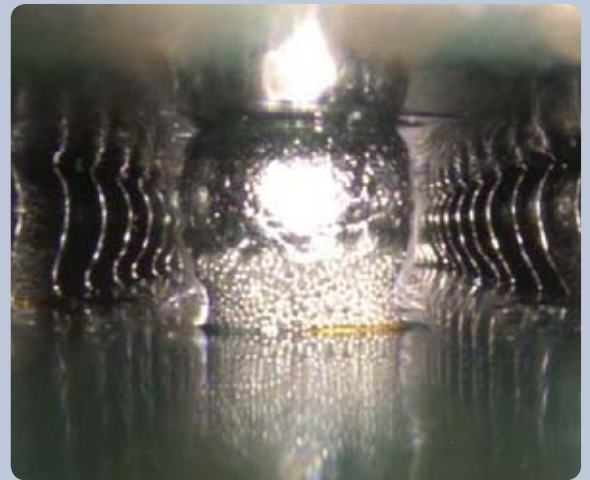

The image process function “Best Focus” enables the ERSASCOPE user to easily find, for any freely determined portion of the image, the objectively best sharpness setting. This is an especially useful feature when measurements are to be taken within the image.

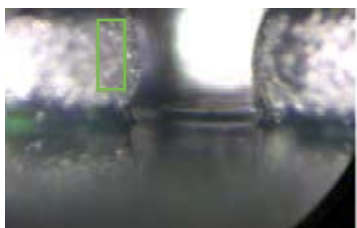

*Best Focus –  
blurred picture in  
the green framed  
section (Area of  
Interest) – red bar  
graph*

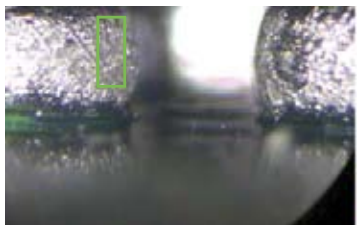

*Best Focus –  
focused picture in  
the green framed  
section (Area of  
Interest) – green  
bar graph*

The second function serves to improve the presentation and documentation of the inspection results. With “Focus Fusion”, the software calculates from a number of previously recorded images a composite image with excellent depth of sharpness. Balls of a BGA, aligned in one row, can be viewed with a high clarity and sharpness. Solder defects or irregular solder joints can be inspected far more easily. The inspection result of a component with high pin-out is documented in only one image.

Both functions are available, starting with Version 3.0, in the well-known Image Doc EXP Inspection software. For existing ERSASCOPE customer an update is available.

## Features ImageDoc EXP

- Live & still picture, AVI recording, sequence module, presentation mode
- „Best Focus” and „Focus Fusion”
- Guided failure analysis, via extensive knowledge database (over 450 MB)
- Reference pictures
- Database with soldering process problems / suggested solutions from Ersa, Fraunhofer and the industry
- Measurement, automatic measure control function/calibration
- Image processing/labelling, filter and macros
- Network operability, multi-user licensing
- User group defined authorities
- Report generation in \*.doc and statistics in \*.xls/database, import/export, e-mail
- On-line updates and user forum

# Inspection applications

## Hidden solder joints & other inspection images

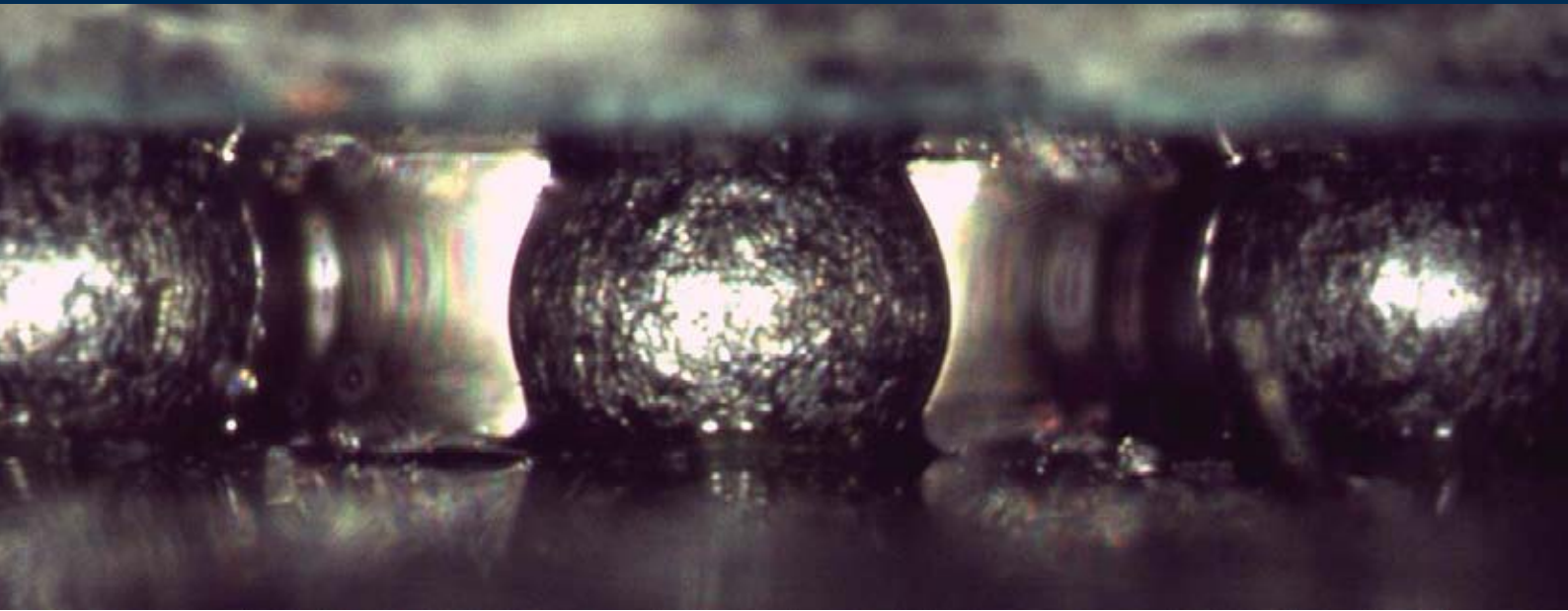

Today's hidden solder joint inspection is one of the most important areas for consideration in a quality assurance program.

The images shown on these pages underscore the flexibility of the ERSASCOPE inspection systems. Whether SMDs or THTs, BGAs or Flip Chips, the ERSASCOPE offers the perfect complement to existing microscopes and x-ray systems for a total quality assurance program.



*PBGA – scaling: insufficient heat*

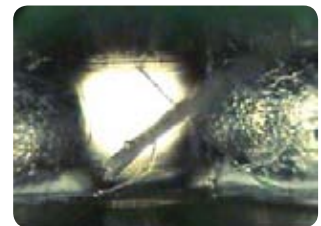

*BGA: contamination (fibre)*



*BGA – "Dark islands": overheat*



*BGA: via hole solder splash*

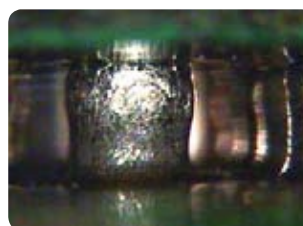

*CBGA: good wetting angle*

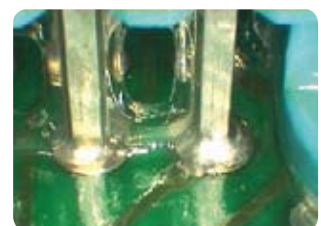

*Conformal coating inspection*



Lead free assembly: non-wetting

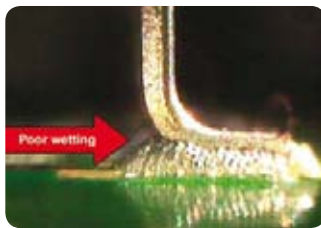

PQFP – interior fillet: poor wetting



PLCC – interior fillet inspection

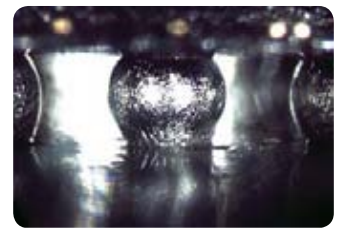

PBGA – cold joint: insufficient heat

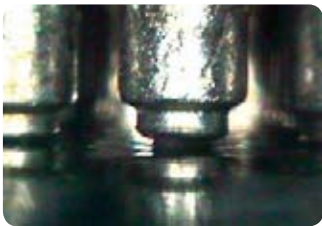

CCGA: insufficient solder



BGA – piggy back: bad alignment

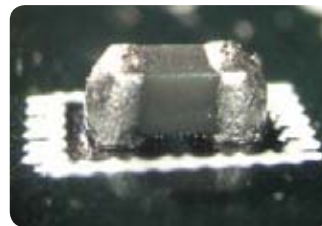

0402: bulbous solder joint



PBGA: tin whisker



Lead free assembly: non-wetting



BGA – paste print: insufficient solder

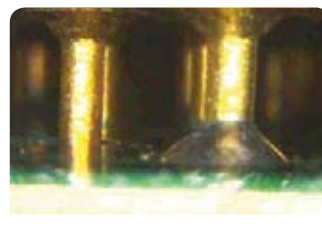

PGA – no flow thru: insufficient heat



PBGA – scaling: insufficient heat



Lead free PLCC: micro crack



TBGA: disrupted joint & micro crack

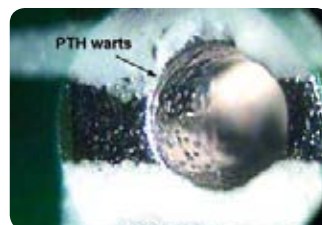

Plated thru-hole: disrupted wall



PBGA – scaling: insufficient heat



SMD LED inspection



PBGA – scaling: insufficient heat

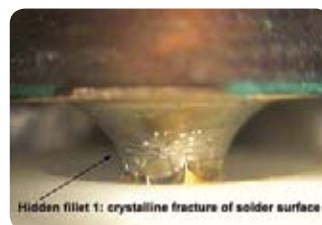

THT joint: crystalline fracture

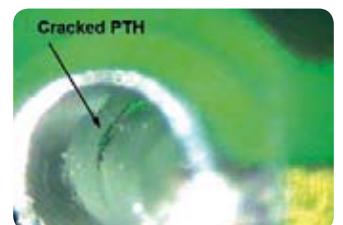

Plated thru-hole: cracked wall

# ERSASCOPE 2

## System configurations & optional items

Order number	Description	Technical data	Part
<b>0VSSC600</b>	<b>Inspection System ERSASCOPE 2</b> , consisting of:		
<b>0VSSE200-T</b>	<b>Optical carrier</b> endoscope with integrated lens and fibre optic system	calibration scale, focus ring and two each mechanical iris for front & back light	
<b>0VSSE200-90K</b>	<b>90° optical lens</b> with integrated lens and fibre optic system	footprint 3 x 6 mm magnification up to 425x* typical inspection gap ~ 300 µm	
<b>0VSSE200-FCK</b>	<b>Flip Chip optical lens</b> with integrated lens and fibre optic system	footprint 1.5 x 4.5 mm (0.6 x 4.0 mm) magnification up to 700x* typical inspection gap ~ 30 µm	
<b>0VSSE200-0K</b>	<b>0° optical lens</b> for surface inspection	footprint ø 6 mm; magnification up to 250x* <b>*20" monitor, 1600 x 1200 pixel resolution, no digital zoom</b>	
<b>0VSCA2240</b>	<b>High resolution CCD</b> color inspection camera	SXGA digital (USB 2.0) manual or auto white balance 1.3 million pixels; 1/3" CCD chip	
<b>0VSTV200</b>	<b>TV adapter</b> connects optical carrier to CCD camera	60 mm focus area C-Mount type	
<b>0VSL300</b>	<b>Light source MHLS</b> Metal Halide Light Source with long-life metal halide bulb	(W x H x D): 175 x 82.5 x 202 mm 220 V - 240 V~, 50 Hz, 120 W or 115 V - 127 V~, 60 Hz, 120 W weight: ~ 2.5 kg	
<b>0VSLR200</b> ●	<b>Light regulator for gooseneck</b>	mechanical iris adjusts 0 to 100 %	
<b>0VSLVL200</b> ●	<b>Light fibre extension</b>	L 200 mm	
<b>0VSLF200</b> ●	<b>Fibre light fan</b>	L 35 mm, W 5 mm	
<b>0VSLF300</b> ●	<b>Fibre optic light brush</b>	L 80 mm, W ~10 to ~35 mm	
<b>0VSRM100</b> ●	<b>Glass calibration scale</b>	10 µm lines at 100 µm pitch	
<b>0VSLC100</b> ●	<b>Lens cleaning kit</b>	cleaning cloth, papers & liquid	
<b>0VSSH100</b> ●	<b>Dust cover</b>	antistatic textile	
<b>3VP00640</b> ●	<b>Storage case</b>	(W x H x D): ~ 325 x 230 x 110 mm aluminum with padded insert	
<b>0VSST210</b>	<b>ERSASCOPE stand</b> with z-axis micrometer adjustment; integrated fibre optics & camera cables	(W x H x D): ~ 500 x 400 x 520 mm total weight ~ 5 kg surface: antistatic includes 1000 mm coated fibre optic cable with gooseneck	
<b>0VSXY100</b>	<b>ERSASCOPE 2 table</b> with 4 each PCB supports	X-Y-θ movement with fine adjust wheels and antistatic mat with grid dimension: ø 320 mm; weight: ~ 5 kg	
<b>0VSD300L</b> ● ●	<b>ImageDoc EXP 3.x</b>	upgrade licence professional inspection software ImageDoc EXP	
<b>0VSD135</b>	<b>ImageDoc Basic</b>	general inspection software	



● = Optional for ERSASCOPE 1;







● = Optional for ERSASCOPE 2



# ERSASCOPE 1

## System configurations & optional items

Order number	Description	Technical data	Part
<b>0VSSC070</b>	<b>Inspection System ERSASCOPE 1</b> , consisting of:		
<b>0VSSE100</b>	<b>ERSASCOPE 1</b> endoscope with integrated lens and fibre optic system	focus ring & adjustable back light footprint 1.5 x 4.5 mm magnification up to 400x* typical inspection gap ~ 300 µm	
<b>0VSCA1225</b>	<b>Digital USB camera</b> color inspection camera	digital (USB 2.0) manual or auto white balance 1/3" CMOS chip	
<b>0VSTV036</b>	<b>TV adapter</b> connects optical carrier to CCD camera	60 mm focal length C-Mount type	
<b>0VSL070</b>	<b>Halogen light source</b> adjustable	(W x H x D): 130 x 55 x 235 mm 220 V - 240 V~, 50 Hz, 45 W or 115 V - 127 V~, 60 Hz, 45 W weight: ~ 1.8 kg	
<b>0VSS210</b>	<b>ERSASCOPE stand</b> with z-axis micrometer adjustment; integrated fibre optics & camera cables	(W x H x D): ~ 500 x 400 x 520 mm total weight ~ 5 kg surface: antistatic includes 1000 mm coated fibre optic cable with gooseneck	
<b>0VSXY090</b>	<b>ERSASCOPE 1 table</b> with 4 PCB support columns	X-Y movement with fine adjust wheels; antistatic mat with grid dimension: ø 320 mm; weight: ~ 3 kg	
<b>0VSI135</b>	<b>ImageDoc Basic</b>	general inspection software	

Order number	Description	Technical data	Part
<b>0VSUP6XL</b> ● ●	<b>Upgrade kit XL</b> upgrades the ERSASCOPE stand and table for inspection of very large PCBs	antistatic XL table (600 x 700 mm), telescopic arm, optic holder and light cable extender	
<b>0VSMS100</b> ●	<b>MAGNISCOPE</b> 0° static endoscope with integrated lens & fibre optic system	focus ring magnification up to 400x* <b>*20" monitor, 1600 x 1200 pixel resolution</b>	
<b>0VSMZ100</b> ● ●	<b>MACROZOOM lens</b> for high magnification top view surface inspection	70x zoom lens aperture adjustment: F 5.6 – 32 C focus adjustment: 180 – 450 mm	
<b>0VSFR100</b> ● ●	<b>MACROZOOM ring light</b>	optical fibre ring light	
<b>0VSMZ300H</b> ● <b>0VSMZ200H</b> ●	<b>MACROZOOM holder</b>	connects lens to stand	
<b>0VSSC600VK</b> ●	<b>ERSASCOPE 2 Upgrade kit</b> upgrade to ERSASCOPE 2	for complete ordering info, contact your Ersas representative directly	

● = Optional for ERSASCOPE 1;

● = Optional for ERSASCOPE 2

# Ersa MOBILE SCOPE

## System configurations & optional items

Basic camera unit	Description	
Image sensor	1/3.2" N-MOS solid state color image sensor	 <p><b>0VSCA060</b></p>
Number of effective pixels	1600 (H) x 1200 (V) pixels (UXGA / 2.0 MP)	
Interface	USB 2.0 serial bus	
Dimensions	114 (L) x 36 (W) x 51 (H) mm (without cable)	

BGA Lens, 90° Optical Head	Description	
On screen magnification	~ 180x – 15x on 14" monitor	 <p><b>0VSSE060-90K</b></p>
Working distance range	~ 0.5 – 30 mm (focusing range)	
Field of view	~ 2,0 – 24 mm	
Illumination	Integrated long-life cool white LED illumination	

Macro-Zoom 80x with LED light	Description	
On screen magnification	~ 80x – 8x on 14" monitor	 <p><b>0VSSE060-MZ80</b></p>
Working distance range	~ 5 – 200 mm	
Field of view	~ 5 – 45 mm	
Illumination	Integrated long-life cool white LED illumination	
Dimensions	83 (L) x 20 (ø) mm (max. 83 x 30 mm)	

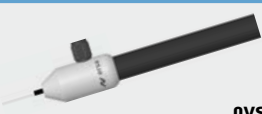
LED brush light	Description	
Leuchtmittel	Cool white power LED	 <p><b>0VSLS030</b></p>
Illumination output	64 x 0.250 mm (ø) plastic optical grade fibres	
Stromquelle	3 x AA (LR06) Batterien (Alkalibatterien empfohlen)	
Dimensions	ø 26 x 250 mm (max. 40 x 250 mm)	

### Ersa MOBILE SCOPE sale sets

Order number	0VSSC060VK1	0VSSC060VK2	0VSSC060VK3
Basic camera unit, digital	1x	1x	1x
BGA lens, 90° optical head	1x	--	1x
Macro-Zoom 80x with LED light	--	1x	1x
LED brush light with dimmer	1x	--	1x
Desktop holder for camera unit	1x	--	1x
Operating manual	1x	1x	1x
ImageDoc Basic (inspection software)	1x	1x	1x
Aluminium case for Ersa MOBILE SCOPE	--	--	1x

### Accessory Ersa MOBILE SCOPE

Product name	Order number
Focusing stand, coarse/fine movement	<b>0VSST060</b>
Focusing stand	<b>0VSST065</b>
X-Y table	<b>0VSXY060</b>
Stand for LED brush light	<b>0VSLS030H</b>
Foot switch for triggering image - with USB connection	<b>0VSCA060FS</b>
Ersa lens cleaning kit	<b>0VSLC100</b>
Aluminium case for Ersa MOBILE SCOPE	<b>3VP00703</b>

# Ersa – We can help you even more!

## Benefit also from our Soldering Irons, Soldering Systems, Stencil Printers and Training offers

### **Innovative and efficient tools and machines to raise the productivity of your electronic production**

Ersa, Europe's largest manufacturer of soldering systems, has the largest product range for the joining technology as applied in electronic production.

#### **Hand- and Rework soldering tools**

An example from the Ersa Hand soldering tools product range is the multi-channel soldering- and desoldering station i-CON VARIO, which satisfies the highest demands on soldering and desoldering. This flagship of the i-CON family makes available to the user 4 different tools for mastering complex soldering tasks: flexible soldering and desoldering with contact-less heat transfer with the new, ergonomically designed hot air soldering iron i-TOOL AIR S, efficient soldering with the powerful, 150 W i-TOOL, accurate desoldering of even the smallest components with the new desoldering tweezers CHIP TOOL VARIO, and desoldering through hole components with the X-TOOL.

More information about these as well as other members of the comprehensive line of hand tools from Ersa you will find out from the product catalog Ersa Soldering Tools or from our website.

#### **Printers and Soldering Systems**

In our business group "systems" we manufacture stencil printers, reflow systems as well as wave- and selective soldering systems. Through our longstanding cooperation with many manufacturers of electronic products all



*Extremely handy, precise and powerful – the new CHIP TOOL VARIO desoldering tweezers*

over the world, our knowledge of what is required by the industry has always kept pace with new developments and new processes. Reliability, low defect rates, continuous productivity improvements while keeping the consumption of resources at a very low level as well as low maintenance costs are challenges, which are faced and mastered by Ersa on a daily basis. Learn more on our website.

#### **Employee training and services**

Ersa offers a comprehensive service program on all levels. Within it, employee qualification takes on more and more importance. You also can benefit through qualifying your employees by having them participate in our training and continuous education programs. More information and current dates you will find in our program flyers or on our website.



*Ersa selective soldering technology is globally leading*



# Electronics Production Equipment Present in 135 countries

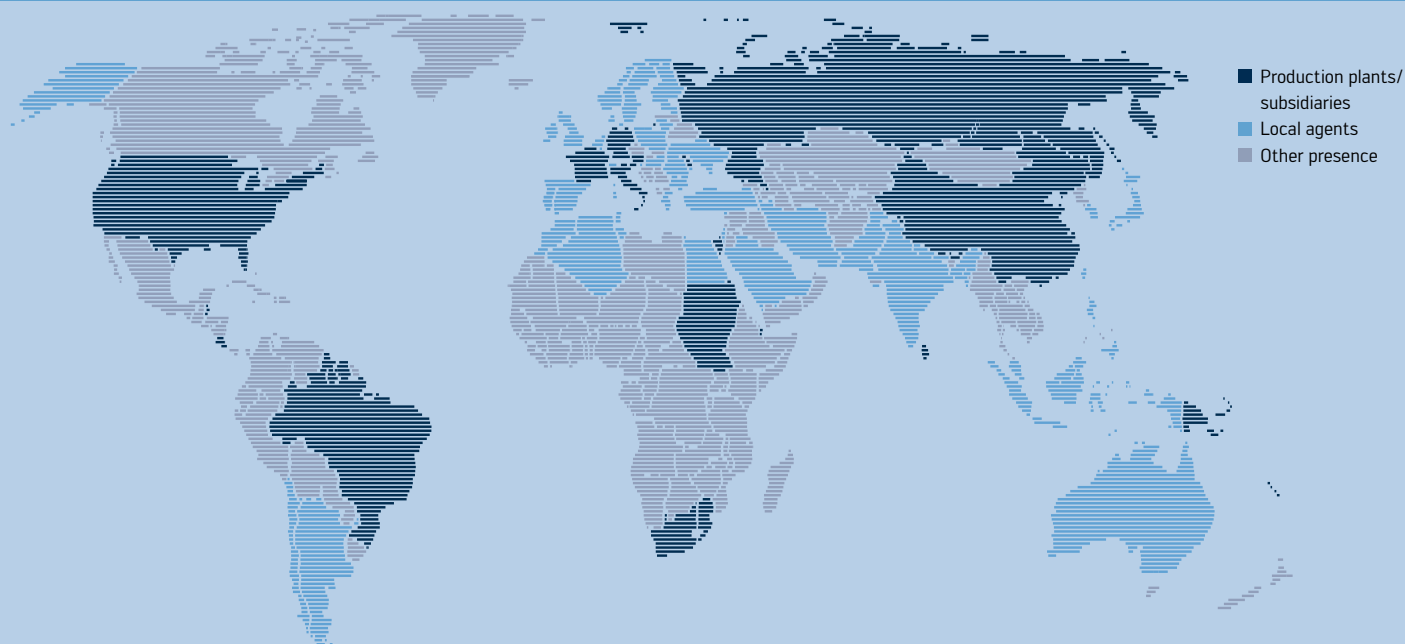

America  
Ersa North America  
1779 Pilgrim Road  
Plymouth, WI 53073  
USA  
Tel. 800-363-3772  
Fax +1 920-893-3322  
info-ena@kurtzrsa.com  
www.ersa.com

Asia  
Ersa Asia Pacific  
Flat A, 12/F, Max Share Centre  
373 King's Road  
North Point, Hong Kong  
China  
Tel. +852 2331 2232  
Fax +852 2758 7749  
info-kfe@kurtzrsa.com  
www.ersa.com

Ersa Shanghai  
Room 720, Tian Xiang Building  
No. 1068 Mao Tai Rd.  
Shanghai 200336  
China  
Tel. +86 213126 0818  
Fax +86 215239 2001  
info-esh@kurtzrsa.com  
www.ersa.com

France  
Ersa France  
Division de Kurtz France S.A.R.L  
15 rue de la Sucharde  
21800 Cevigny Saint Sauveur  
France  
Tel. +33 3 80 56 66 10  
Fax +33 3 80 56 66 16  
info@ersa-electronics.fr  
www.ersa-electronics.fr

Kurtz Holding GmbH & Co.  
Beteiligungs KG  
Frankenstr. 2  
97892 Kreuzwertheim  
Tel. +49 9342 807-0  
Fax +49 9342 807-404  
info@kurtzrsa.de  
www.kurtzrsa.de

Ersa GmbH (Headquarters)  
Leonhard-Karl-Str. 24  
97877 Wertheim/Germany

Tel. +49 9342 800-0  
Fax +49 9342 800-127  
info@ersa.de  
www.ersa.com