

Vision Engineering is a global manufacturer of ergonomic stereo microscopes, digital inspection systems and optical and video measuring systems.

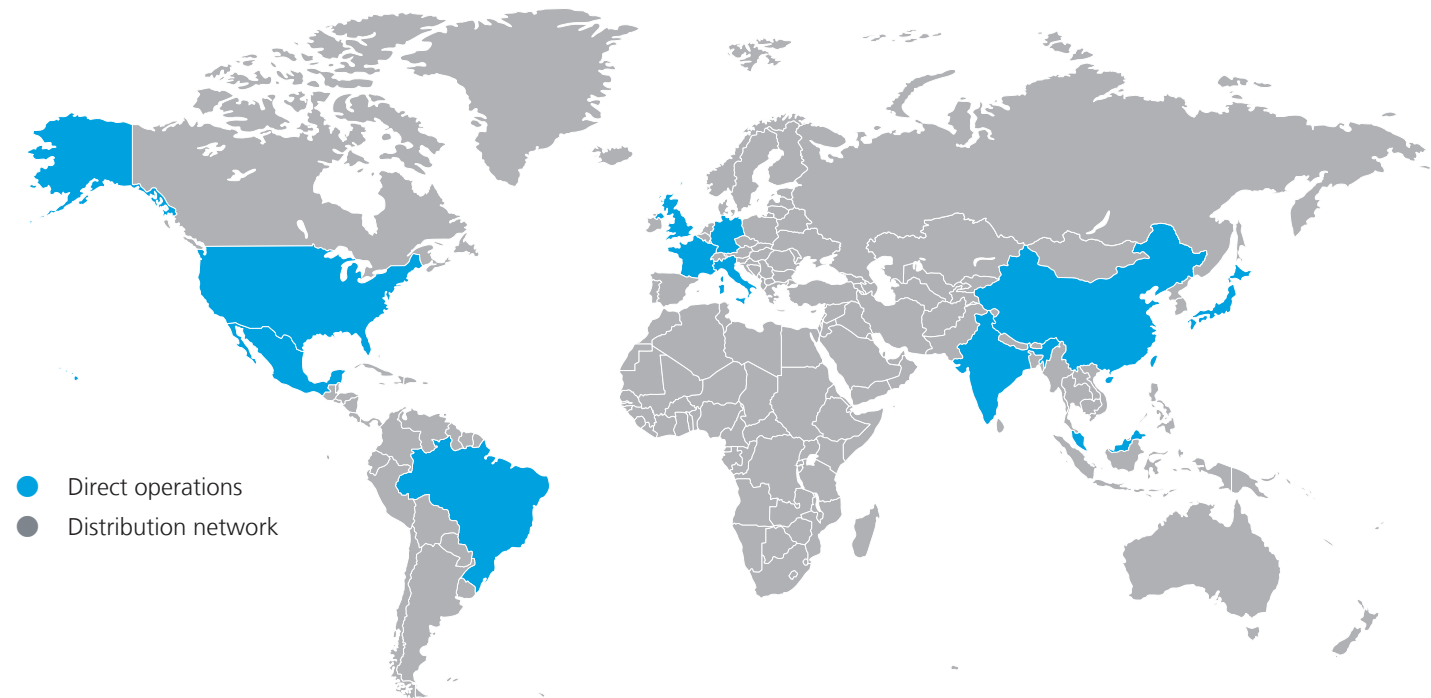

- Direct operations
- Distribution network



**For more information**

For more information, please contact your Vision Engineering branch, local authorized distributor, or visit our website.

Distributor



**Vision Engineering Ltd.**  
(UK Manufacturing & Commercial)  
The Freeman Building, Galileo Drive,  
Send, Surrey, GU23 7ER, UK  
Tel: +44 (0) 1483 248300  
Email: generalinfo@visioneng.com

**Vision Engineering Ltd.**  
(Italy)  
Via G. Paisiello 106  
20092 Cinisello Balsamo MI, Italia  
Tel: +39 02 6129 3518  
Email: info@visioneng.it

**Vision Engineering**  
(South East Asia)  
P-03A-20, Impian Meridian,  
Jalan Subang 1,  
USJ 1, 47600 Subang Jaya,  
Selangor Darul Ehsan, Malaysia  
Tel: +604-619 2622  
Email: info@visioneng.asia

**Vision Engineering**  
(Mexico)  
Tel: +01 800 099 5325  
Email: infomx@visioneng.com

**Vision Engineering Inc.**  
(NA Manufacturing & Commercial)  
570 Danbury Road,  
New Milford, CT 06776, USA  
Tel: +1 (860) 355 3776  
Email: info@visioneng.com

**Vision Engineering Ltd.**  
(France)  
ZAC de la Tremblaie,  
Av. de la Tremblaie  
91220 Le Plessis Paté, France  
Tel: +33 (0) 160 76 60 00  
Email: info@visioneng.fr

**Vision Engineering**  
(China)  
Room 904B, Building B, No.970,  
Nanning Road, Xuhui Vanke Center  
Shanghai, 200235, P.R. China  
Tel: +86 (0) 21 5036 7556  
Email: info@visioneng.com.cn

**Vision Engineering**  
(Brasil)  
Email: info@visioneng.com.br

**Vision Engineering Ltd.**  
(Central Europe)  
Anton-Pendle-Str. 3,  
82275 Emmering, Deutschland  
Tel: +49 (0) 8141 40167-0  
Email: info@visioneng.de

**Nippon Vision Engineering**  
(Japan)  
272-2 Saedo-cho, Tsuduki-ku,  
Yokohama-shi, 224-0054, Japan  
Tel: +81 (0) 45 935 1117  
Email: info@visioneng.jp

**Vision Engineering**  
(India)  
Tel: +91 (0) 80-5555-33-60  
Email: info@visioneng.co.in

EV2\_enUS1.0/0218 Copyright © 2018 Vision Engineering Ltd. All rights reserved.

**EVOCAM**  
Power your productivity

**High definition digital microscope**

- ✓ Exceptional high resolution 1080p/60fps image quality
- ✓ Intuitive image capture and documentation
- ✓ Stand alone, wireless or PC connectivity
- ✓ High quality stands for precision and stability
- ✓ Unique 360° rotating viewer



FM 584026

Vision Engineering Inc. has been certified for the quality management system ISO 9001:2008.

visioneng.us/evocam2



www.visioneng.us

Making image capture and documentation simpler, faster and more reliable - wherever ultra sharp images are required for inspection, fault analysis and much more.

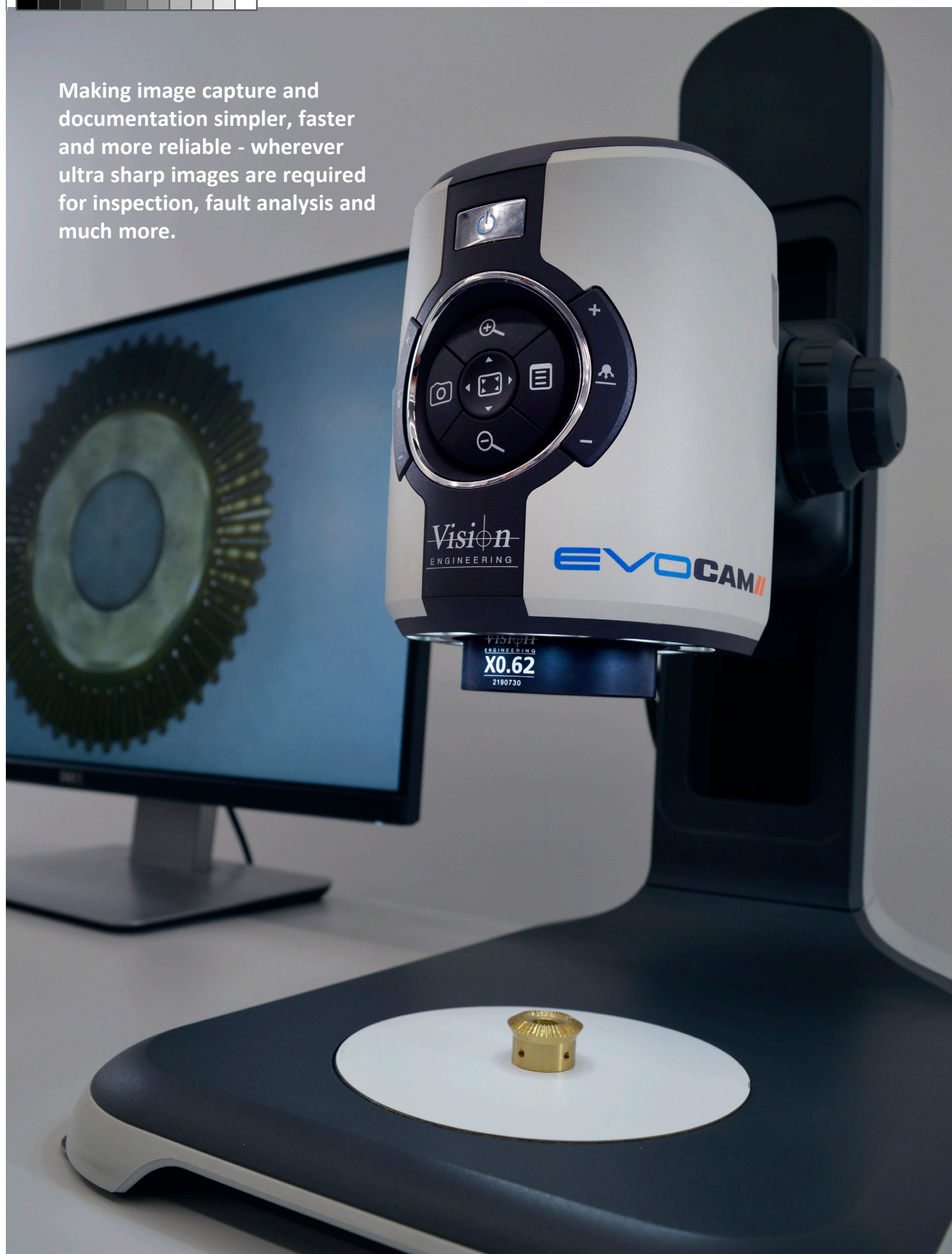

## Power your productivity

### EVO Cam II high definition digital microscope

EVO Cam II digital microscope delivers excellent image quality to help uncover hidden details. Optical magnification up to 300x and full autofocus to ensures ultra-sharp images at all times.

EVO Cam II provides the ability to measure complex parts efficiently and quickly using overlays or point to point measurement.

Capture high resolution images at the touch of a button either direct to USB memory stick, via wireless or direct to a PC.

10 programmable presets allows camera settings be saved for quick and easy recall. Presets can be exported and imported allowing users to share settings between units and sites ensuring consistency of inspection. Calibration can also be saved in presets for quick recall.



### Highlights

- Ultra-sharp image quality with full autofocus
- Optical magnification range 1.7x -300x
- Maximum magnification with digital zoom 3600x
- Fast 60 fps provides clear images without motion blur
- Full 360° inspection without the need to manipulate subjects under magnification
- Large field of view and long working distances
- Eliminate set-up time with up to 10 presets
- Custom overlays to aid inspection
- Wi-Fi and USB 3.0 for fast image transfer
- Efficient dimensioning with virtual caliper and scalable grids

### Ease of use

Simplicity is at the heart of EVO Cam II. Easy to follow menu and simple operation minimizes training and is an ideal solution for multiple users in high speed production environments.

An overview function allows you easily locate a point of interest on the object you are viewing.

The on-screen function menu for the EVO Cam II is also available in multiple languages.

In addition to the convenient operation of all main functions on the unit, a remote control console allows faster and more comfortable use.

## Optics & Illumination



A range of objective lens options ensure stunning results for any application, whether for high magnification, high precision detail inspections, or for manipulation, re-work and assembly tasks requiring an extra long working distance.

### Precision objective lenses

Ultra-high resolution and contrast, optimized for precision magnification work with definition excellence.

### Wide-field objective lenses

Wide field of view, suited for larger subjects. An extra long working distance provides maximum flexibility and large zoom range for flexible operations. Suitable for larger subjects.

Objective lens	Magnification zoom range*	Working distance	Field of view at max. zoom
<b>Precision objective lenses</b>			
0.45x	2.3x - 68x	6.30" (160mm)	0.31" x 0.17" (7.8mm x 4.2mm)
0.62x	3.1x - 93.7x	4.17" (106mm)	0.22" x 0.12" (5.5mm x 3.1mm)
1.0x	5x - 151.2x	3.35" (85mm)	0.14" x 0.08" (3.5mm x 2mm)
1.5x	7.6x - 226.8x	1.69" (43mm)	0.09" x 0.05" (2.3mm x 1.2mm)
2.0x	10x - 302.4x	1.14" (29mm)	0.06" x 0.04" (1.5mm x 1.0mm)
<b>Wide-field objective lenses</b>			
4 diopter	1.71x - 51.41x	9.65" (245mm)	0.39" x 0.22" (10mm x 5.5mm)
5 diopter	2.12x - 65.5x	7.76" (197mm)	0.31" x 0.18" (8mm x 4.5mm)

\*with 24" monitor

### Camera

Auto exposure and aperture priority allow control of target brightness with difficult subjects and enables easy control of depth of field. Selectable gain, iris and exposure time enables full control of image parameters where manual control is desired.

Camera zoom	30x optical; 12x digital
Camera resolution	1080p, 1920x1080, 1/2.8" CMOS
Frame rate	50fps & 60fps (switchable)
Output	HDMI & USB 3.0 out
Saved file type	.png



### LED ring light

Integral 8-point LED ring light ensures optimum shadow-free illumination for all applications. Color temperature 5500K.

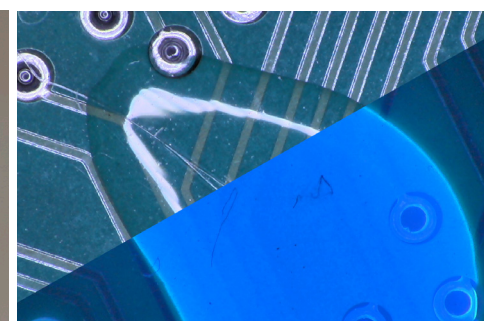

### UV ring light

The UV ring light is an excellent optional EVO Cam II accessory. It is suitable for many applications ranging from electronics, aerospace and forensics.



### Substage illumination

The substage illumination lights a subject from beneath. It is suitable for inspection of translucent materials.

## Measurement & Image Transfer

### Measurement

EVO Cam II includes easy on-screen measurement capability, with selectable overlays, grid and cursors.

Cursor mode displays two movable horizontal and vertical lines, allowing measurement of X and Y values with results displayed on screen. Also point to point diagonal measurement allows measurement of non-aligned items.

Grids can be displayed, scaled and positioned as required.

Customizable overlays are easily created and imported into the camera allowing easy comparison against drawings, samples or reticules.

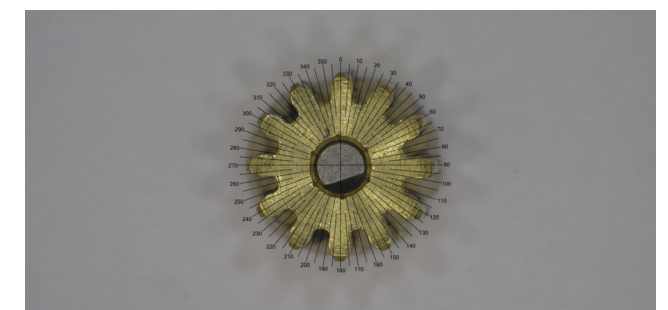
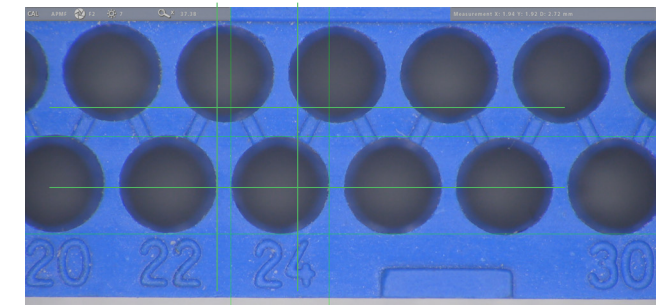

### Image Transfer

Images can easily be captured and saved from the EVO Cam II directly to a USB dongle at the touch of a button.

Alternatively they can be transferred securely to a computer via cable output (HDMI or USB 3.0) or wireless using a Wi-Fi dongle.

Using the Wi-Fi dongle option allows a user to quickly view and download images and videos, and is ideal when access for multiple users is required.



### Remote control console

The remote control console helps to improve user comfort and is a convenient tool to help a user quickly access their presets.



### Filters

There are a range of filters available, to enhance details within subjects not easily seen by the human eye.

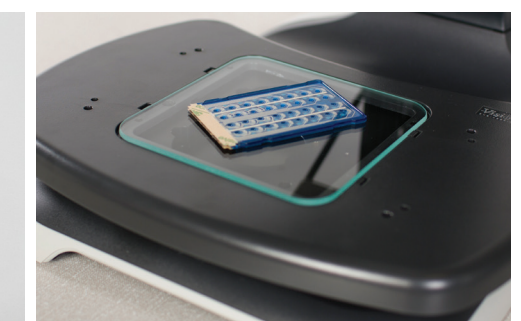

### Floating stage

A floating stage provides smooth and precise control. It is ideal for checking uniformity of components, or inspecting sensitive samples (Ergo/Bench stands only)

## 360° rotating viewer

This unique feature offers a full 360° rotating view without the need to move the subject under magnification, making inspection easier and quicker.

The 34° angle allows detail to be seen at the base of any vertical component or feature.

Operators can simply switch between rotating oblique view and a direct view for ultimate flexibility.

- Includes integrated 8-point LED ring light and objective lens

360° rotating view					
Zoom ratio	Zoom range	Working distance	Field of view at min. zoom	Field of view at max. zoom	Viewing angle
5.3:1	19x – 105x	35.5mm	25.7mm x 22.1mm	2.6mm x 2.2mm	34° from vertical

Direct view					
Zoom ratio	Zoom range	Working distance	Field of view at min. zoom	Field of view at max. zoom	Viewing angle
5.3:1	28x – 151x	56.5mm	19.7mm x 11.2mm	1.6mm x 0.9mm	-

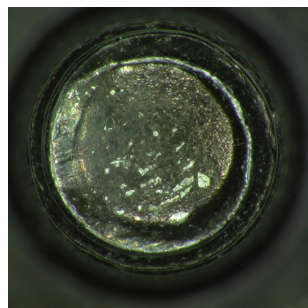

**Direct view:**

The subject is seen from a birds-eye view.



**Rotating oblique view:**

The subject can be viewed from a number of angles.



Find out more at: [www.visioneng.com/evocam2](http://www.visioneng.com/evocam2) »

## Stand options

### Multi-axis stand

- Precise and robust, ideal for industrial applications where maximum work space is desired.
- Integrated gas strut provides counter balanced adjustability, making operation quick and effortless. Switch between tall components and flat samples with ease.
- Available with platform base, or mounted directly to the work surface.

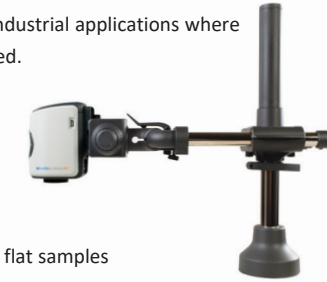

### Double-arm boom stand

- Designed specifically for applications requiring extended reach, without compromising stability.
- Easy adjustability allows precise positioning and alignment.
- Available with platform base, or with clamp for mounting directly to the work surface.



### Single-arm boom stand

- High stability boom stand, ideal for larger specimens.
- Robust stand option, complete with heavy duty platform base and focus module.

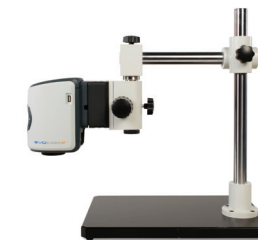

### Ergo stand

- Small footprint providing exceptional stability for high magnification use.
- Transmitted substage illumination option permits viewing of a wider range of sample types.
- Floating stage option provides sensitive control for accurate inspection of samples; ideal for inspecting fragile samples, or for avoiding contamination by handling.
- Coarse and fine focus counter for high magnification subjects



### Articulated arm stand

- Designed for applications requiring extended reach, with ultimate flexibility.
- Multi-point adjustability allows precise positioning and alignment.



### Bench stand

- Compact unit with low-profile base and integral transmitted substage illumination.
- Floating stage option provides sensitive control for accurate inspection of samples.
- For use with 1.0x objective.

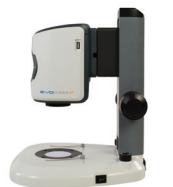

View full technical details at: [www.visioneng.com/evocam2](http://www.visioneng.com/evocam2) »

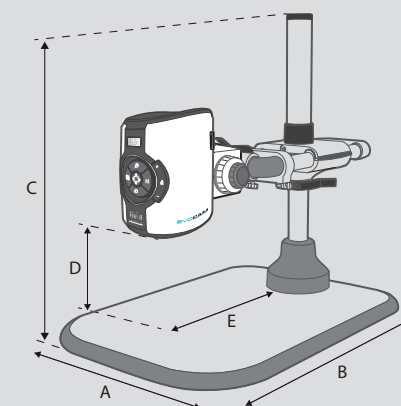

**Multi-axis stand dimensions:**  
 A = 17.9" (455mm), 7.2" (184mm)\*\*  
 B = 26.9" - 32.7" (682mm - 830mm)  
 C = 27.2" (691mm) max.  
 D = 11" (279mm) max.  
 E = 17.3" (439mm) max.

\*\* without platform base.

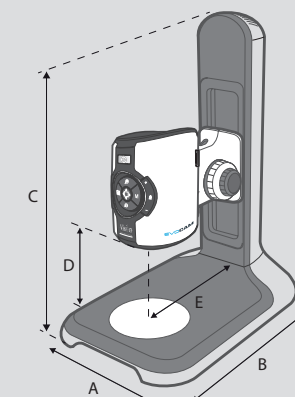

**Ergo stand dimensions:**  
 A = 11" (280mm)  
 B = 16.5" (420mm)  
 C = 20.3" (515mm)  
 D = 7.6" (192mm) max.  
 E = 7.9" (200mm)