

Specifications			
Machine Type	High Speed Machine	LED Machine	Multi Function Machine
The Number of Spindles	20 Spindle x 2 Gantry (Rotary Type)		6 Spindle x 2 Gantry (Piano Type)
Placement Speed	80,000 CPH (Optimum)		60,000 CPH (Optimum)
Placement Accuracy	Chip	±25 μm @ Cpk ≥ 1.0	±40 μm @ Cpk ≥ 1.0
	IC	-	±30 μm @ Cpk ≥ 1.0
Component Range	Size	0201 ~ □ 6 mm	0402 ~ □ 55 mm
	Max. Height	2 mm	15 mm
PCB Size (mm)	Single	Standard: L510 x W580, Option: L750 x W580	
	Dual	Standard: L510 x W310, Option: L750 x W310	
PCB Thickness (mm)	0.3 ~ 4.2		
Feeder Capacity (8 mm Standard)	80 ea (Docking Cart)	8 ea (Fixed Base)	80 ea (Docking Cart)
Utility	Power	3 Phase, AC 200V / 208V / 220V / 240V / 380V / 415V ±10%	
	Air Consumption	Max. 4.2 kVA 100 Nℓ/min	
Weight (kg)	Approx. 1,605		
External Dimension (mm)	L890 x D2,312 x H1,921		

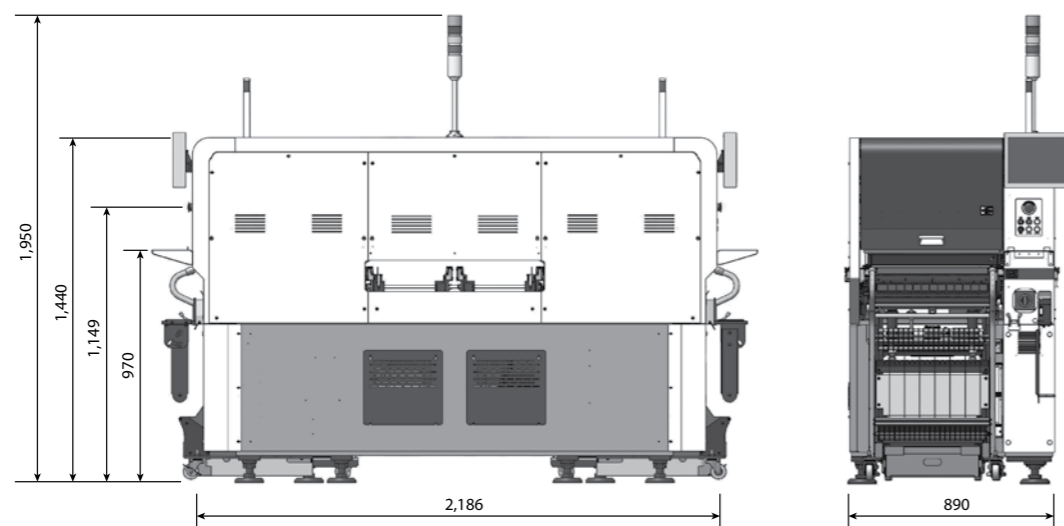

Dimension



Cutting-edge Modular Mounter

HM520



Actual productivity is highest among machines of the same class and is optimized to high quality production

Configures a flexible production line by applying a modular head and various production modes

Realizes unmanned, non-stop, and zero defect production using the Smart Factory S/W Solution



T-Solution

T-IT

Provides solutions for component misplacement prevention and material production history management

T-OLP

Plans the production order of various PCB files with optimum production conditions

T-PNP

Maintains optimum quality through a real time diagnosis report

T-Mobile

Monitors the production status anywhere, anytime, using a tablet PC and smart watch



HS(High Speed) Head

- 20 Spindle x 2 Gantry
- 80,000 CPH
- $\pm 25 \mu\text{m}$ @ $\text{Cpk} \geq 1.0$
- 0201 ~ \square 6 mm (H 2 mm)

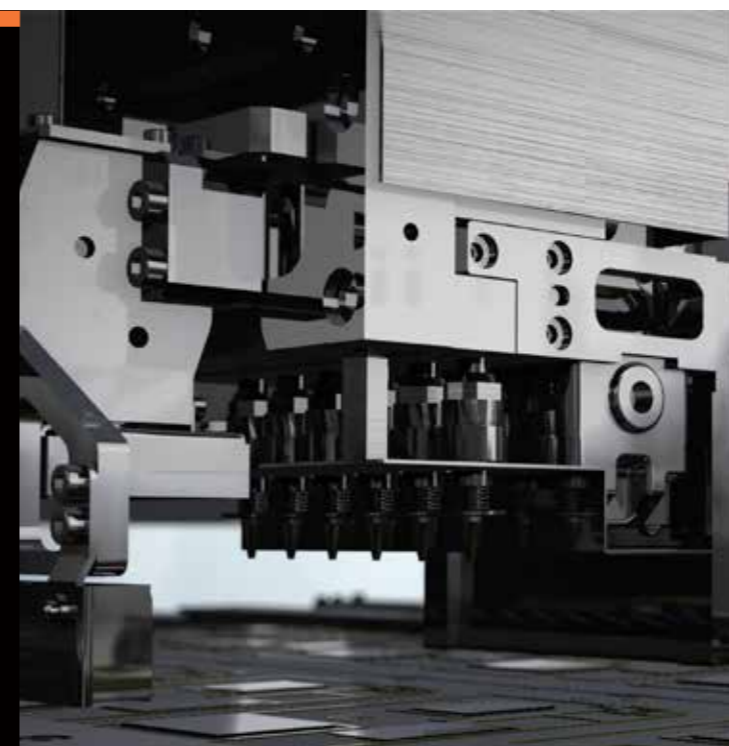

MF(Multi Function) Head

- 6 Spindle x 2 Gantry
- 60,000 CPH
- $\pm 30 \mu\text{m}$ @ $\text{Cpk} \geq 1.0$
- 0402 ~ \square 55 mm (H 15 mm)

HIGH PRODUCTIVITY

20 Spindle Head

Quickly recognizes 20 spindles simultaneously with the fix camera by designing the head to be small and light.



High Speed and High Definition Fix Camera

Possible to do high speed and high-precision placement of Mini LED chips as well as microchips (0402, 0603) for mobile phone PCBs using the high definition camera without a reduction of actual productivity.



HM Feeder (8 mm)

Developed a new HM feeder, which reduces feeding time by approximately 24%.

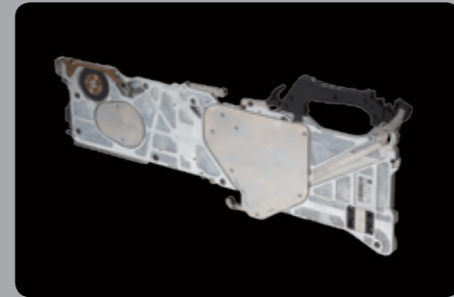

HIGH RELIABILITY

Prevents Non-insertion by the Side View Camera

Prevents non-placement of a component by checking for the existence of a nozzle and the posture of a pickup component during production and by performing an inspection before and after component placement. In addition, prevents a pickup/placement error by measuring the component height in real time to correct the deviation of a component (material) automatically.

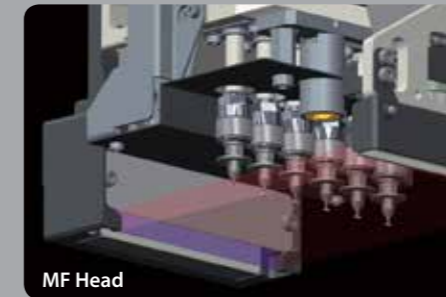
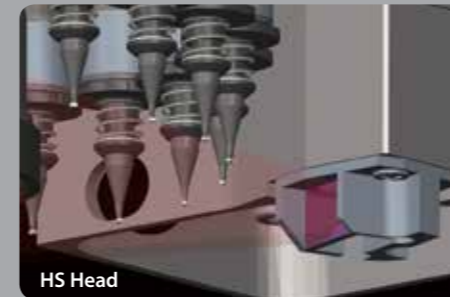

Optimized LED Production

Ensures optimized production with a minimum number of feeders by applying the rotary head, realizing actual productivity of a Max. of 74,000 CPH.

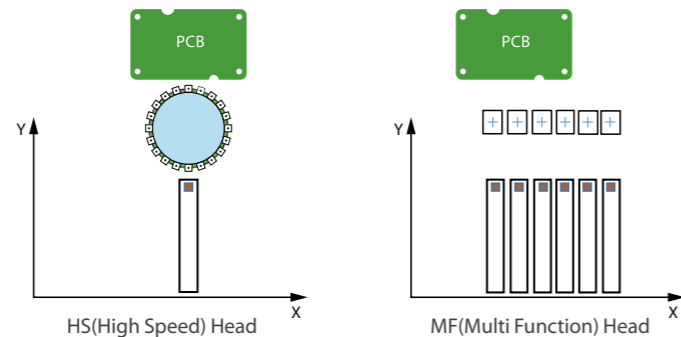

Corrects Pickup/Placement Coordinate Automatically

Corrects the X-Y pickup position and prevents misplacement automatically by tracing the COR data based on the center of the nozzle.

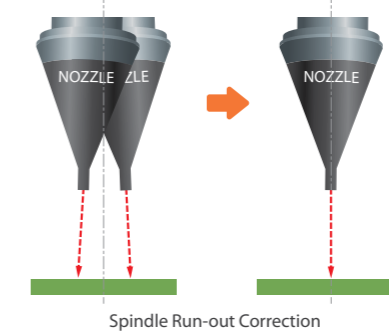

Improved Productivity per Area

Increases the productivity per unit area significantly by minimizing the machine length while increasing the length of an available PCB. (140% compared to DECAN Series models)



Height Sensor

Picks up a component using the height sensor without performing separate teaching and automatically corrects the difference in the placement height due to PCB warping.

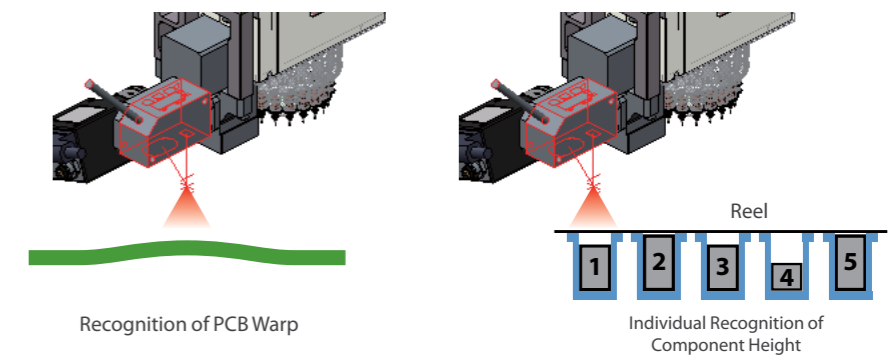

Adopts an Outbuffer

Increases actual productivity by adding an Outbuffer Extension as an option to reduce the transfer time between boards.

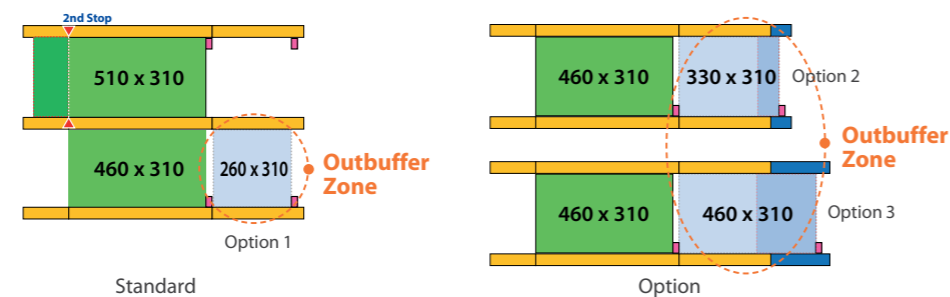

Function to Check for LED Component Flip-over

Prevents a defective placement by checking for component flip-over using the Vision Camera.

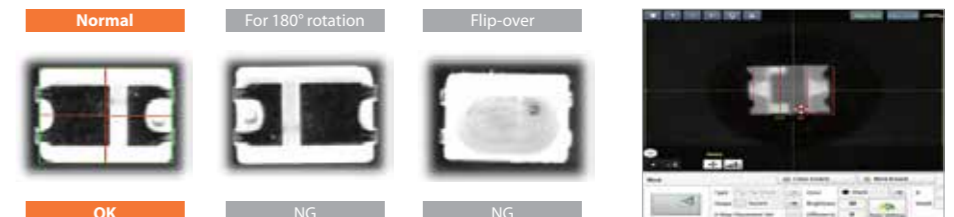

FLEXIBLE PRODUCTION

Family Job Change

Minimizes the model changing time by arranging the feeders and nozzles in common when producing family models.

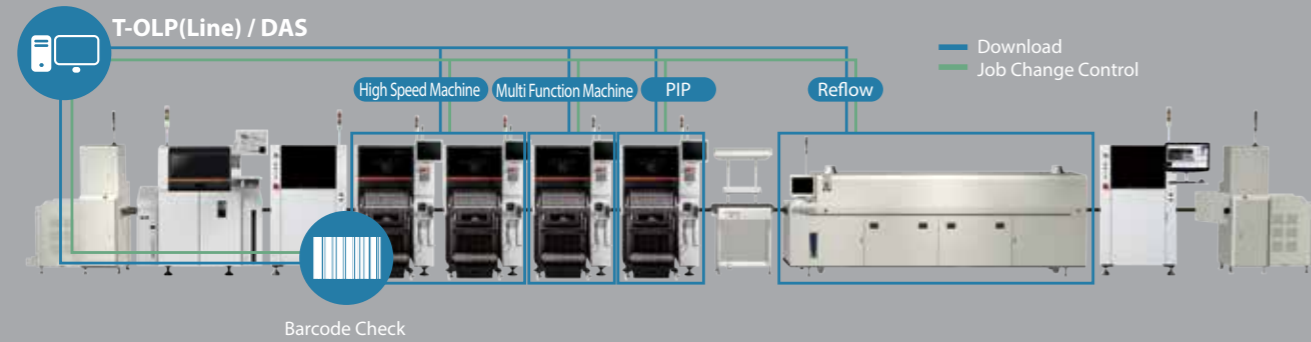

EASY OPERATION

LED Rank / Random

Possible to register a component as a different one by LED rank and arrange placement points at random by LED color.



Random as per Place Distribution

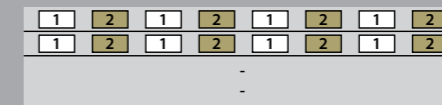

Equal Vertical

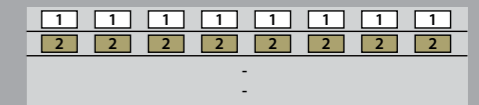

Equal Horizontal

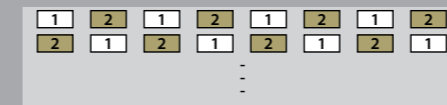

Equal Zigzag

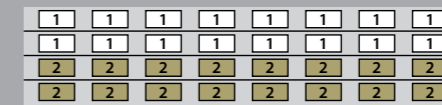

Equal Y-block

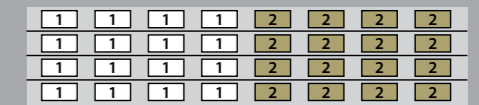

Equal X-block

Provides Various Production Modes

Helps the user to achieve the optimum production conditions by selecting a production mode suitable for the production environment.

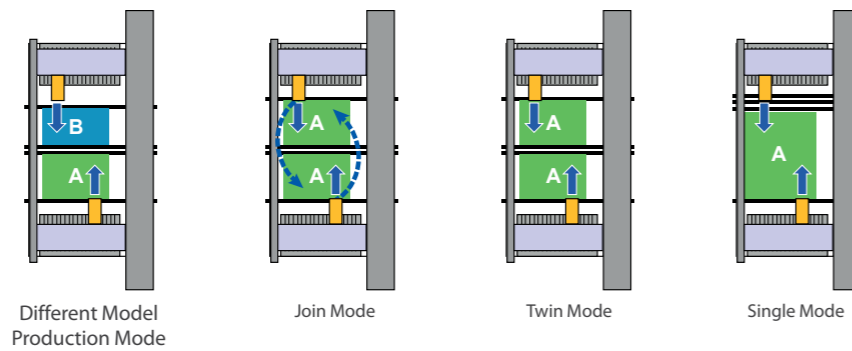

Flexible Applicability to PCBs

Allows mixed production of different models by applying the dual lane, and applies 2 Step placement to be able to respond to up to 750 mm PCBs.

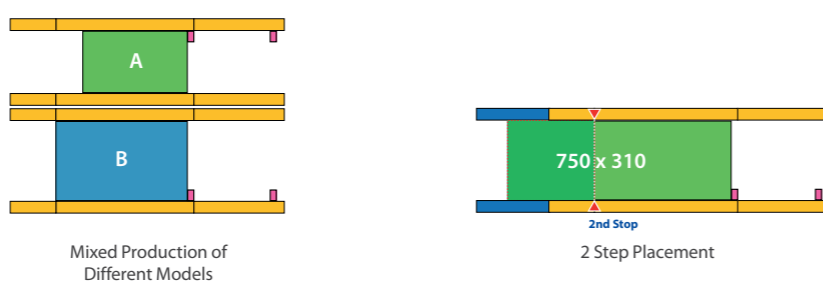

Range of Applicability to Components

Possible to place components from 0201 microchips to a maximum of 55mm components, with a height of a maximum of 15 mm.

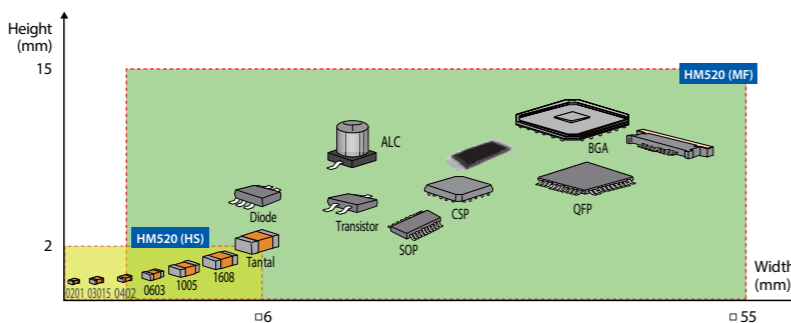

Automatic Nozzle Rearrangement

The fiducial camera recognizes the barcode of the ANC and nozzles to help ensure the optimum rearrangement of nozzles on the ANC block.

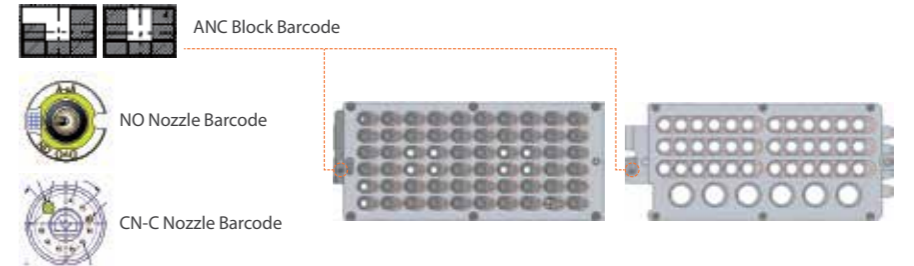

Multi-Vendor Component Support

Manages the same components supplied from two companies as a one Part Name to help create a PCB program and improves the component recognition loss rate due to a difference in vendors.



Improves Convenience When Using Peripheral Devices

It is possible to install a flux dipping unit or 7 sets of 8mm based feeders additionally at the left of the tray feeder. It is also possible to perform cross installation of the tray feeders and docking cart easily within one minute by recognizing them automatically.



SOFTWARE SOLUTIONS

Offline Programming (T-OLP)

- Provides CAD interface, optimization, and line balancing functions.
- Establishes a production plan that considers feeder rearrangement when changing a model using JOB Planning.

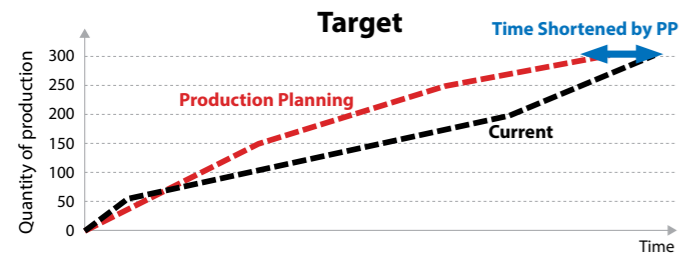

Offline Component Registration and Management (T-ELITE)

- Possible to register the information on a new component quickly using the built-in camera.
- Performs integrated management of the change in the component information.
- Possible to easily search / modify / duplicate / delete the component information registered in the Part Database.



Component Reel Barcode Issue and Registration (T-Part)

- Creates and manages the component reel information by issuing and registering the reel barcode to the component reel.

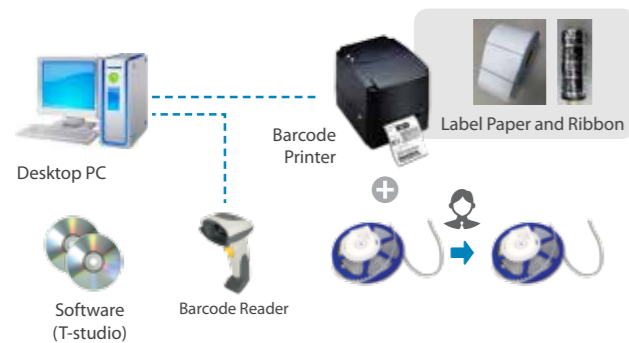

Feeder History Management Tool Support (T-Feeder)

- Manages the feeder calibration history to maintain the feeding quality.
- Possible to easily examine the position of the tape feeder necessary for the next production.



Possible to Prepare the Feeder in Advance of Production

- Minimizes the model changing time using a docking cart before changing a model.
- Helps rearrange feeders easily taking into consideration a maximum of 8 sets of docking carts. (Feeder workstation or FLMS)

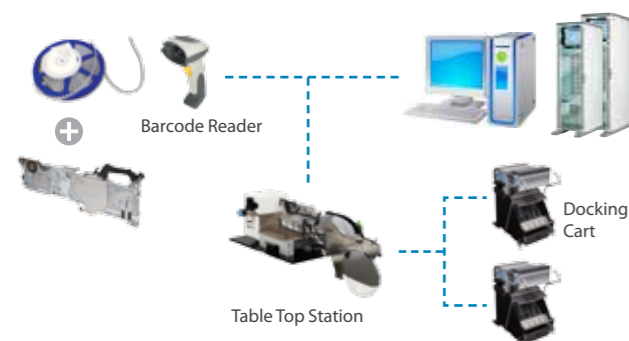

Auto JOB Change (T-OLP)

- Uses the 'Production Reservation' function to automatically change the family models (Multi JOB) in order and reduces production time.



Component Misplacement Prevention

- Inspects collectively whether components supplied by all feeders are the same as those set in the PCB program.
- Prevents misplacement errors by checking whether an appropriate component reel is installed in the corresponding feeder slot.

Production History Management System (LTS)

- Minimizes the range of recall and defective PCB repair that may occur later through the Lot tracking of production.

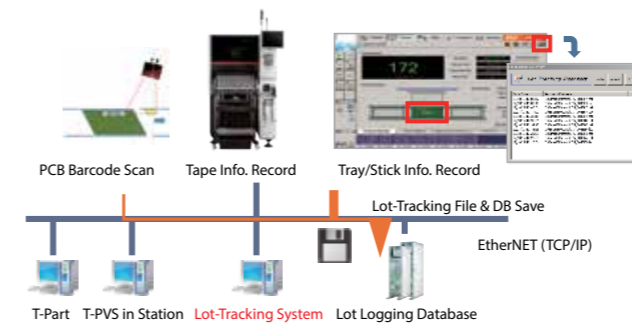

Prevents Production Delay due to a Shortage of Components (T-IT)

- Automatically manages the quantity of components remaining in the reel in use to help prepare components in shortage in advance.
- Adds components in shortage in the Material Request List automatically. Then the material room supplies the components in shortage in real time.

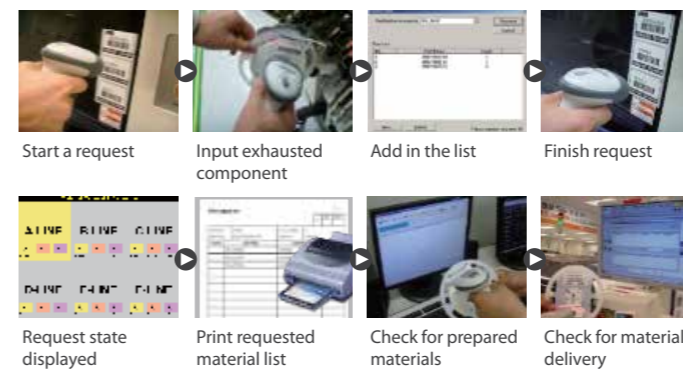

Factory Monitoring and Remote Control System (T-Mobile)

- Possible to monitor the factory through remote connection and to check the error message of the machine/system.
- Possible to check and control the operation conditions of the machine by remote connection to the machine through a tablet device.

Line Management

Major Production Index (KPI) Management and Monitoring (T-PNP)

- Monitors six production indexes and monitors the trend of each index in real time to help take measures against a problem with the line quickly.

Warning against Production Model Change (T-PNP)

- Warns the user against a production model change in advance to prevent a delay in model changing time.

Production History Inquiry and Reporting (T-PNP)

- Inquires about the production history by major index and supports the reporting function through a production index mailing system.

Analysis of the Cause of Defects by Period (T-PNP)

- Examines the cause of defects by analyzing the trend of the production data during a specific period of time and presents solutions.

Alarm Transmission and Maintenance (T-PNP)

- When a major defect occurs, transmits an alarm to the manager to help them take immediate measures against the cause of the defect at the spot.

M2M Communication Support (T-PNP)

- Prevents a defective placement by sharing data between in-line machines and improves productivity.

T-PnP

KPI Management Monitoring

Warn against model change Alarm & Maintenance

HM SERIES LINE

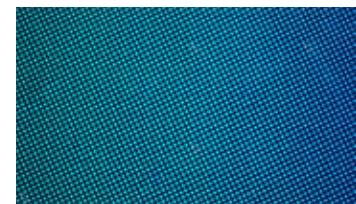

LED Electronic Display



303,000 CPH

LED Display
14,400 Point
Twin Mode

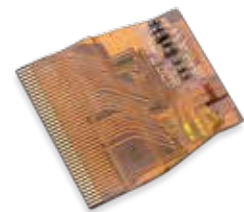

Small F-PCB Module

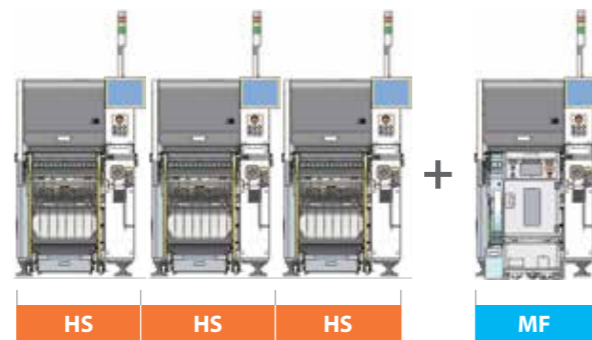

163,000 CPH

Battery Module
608 Point
Twin Mode



Mobile Phone

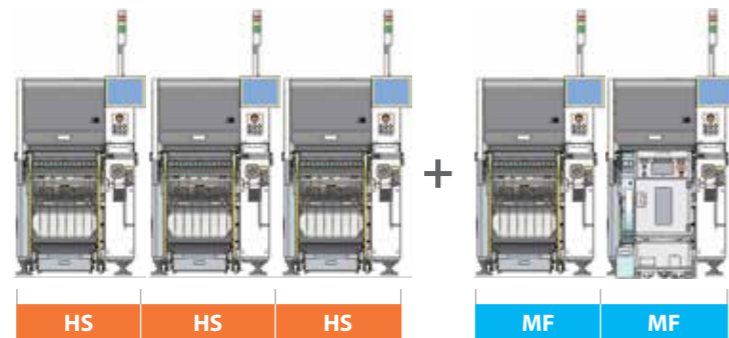

167,000 CPH

Smart Phone
2,700 Point
Join Mode

※ Productivity may differ depending on the operation conditions of a customer.

Tape Feeder

	W4P1	8 mm	12 mm	16 mm	24 mm	32 mm	44 mm	56 mm	72 mm
Tape Width (mm)	4	8	12	16	24	32	44	56	72
Feeding Pitch (mm)	1	2, 4	Min. 4 / Max. Tape Width						
Reel Diameter (mm)	Ø180	Ø178 ~ 330	Ø178 ~ 380	Ø178 ~ 380	Ø178 ~ 380	Ø178 ~ 380	Ø178 ~ 380	Ø178 ~ 380	Ø178 ~ 380
Application	HS	HS / MF	HS / MF	HS / MF	MF	MF	MF	MF	MF

ACCESSORY

HM Feeder

Developed a new HM feeder (8mm), which reduces feeding time by approximately 24% compared to that of existing feeders.



Stick Feeder

Applicable Stick Size (mm)	Min. 300(L) Max. 34(W) x 600(L) x 9 Max. Stick Width: 13mm (when applying 2 sticks)
Installable Stick Quantity	2
Number of Occupied Slots	5
Range of Applicable Components (mm)	Min. 5 x 5 x 1.5 Max. 31 x 31 x 6
Types of Applicable IC Chips	Small Odd-shape Component / Insert Component SOP Type (Small Outline Package) SOJ Type (Small Outline J-lead) QFP Type (Quad Flat Package) PLCC Type (Plastic Leadless Chip Carrier)



Flux Dipping Unit

Distributes flux by sliding method, allowing high speed and high precision POP packaging.

Flux Application Range (Thickness)	
Film Size	56.5 mm (X) x 56.5 mm (Y)
Film Forming Time	Less than 3 seconds (based on the squeegee reciprocating time)
Control Range	0.015mm ~ 0.35mm (Squeegee Gap)
Minimum Application Thickness Adjustment Unit	
	10 μm
Number of Occupied Slots When Installing	
	7
Flux Viscosity	
	101 ~ 20 Pa.S (Operating Temperature 24 ± 4°C)



Tray Feeder

Outline Dimension (mm)	564.6(W) x 750(L) x 918.2(H)
Weight (kg)	Max. 190
Tact Time	4.6 seconds (Single staged → 10-staged)
Tray Size (mm)	Min. 200 x 100 Max. 320 x 230
Magazine	1 Tray / Pallet 10 Pallet / Magazine 2 Magazine / Tray Feeder



Tray Feeder Equipped with a Tape Feeder

Tray Feeder Equipped with a Flux Dipping Unit