



QUANTUM[®]
STORAGE
SYSTEMS

**LOWEST PRICE
GUARANTEED**



• BINS • WIRE SHELVING • CARTS • COMPLETE BIN SYSTEMS

TABLE OF CONTENTS

ULTRA BINS & SYSTEMS

- 4 Ultra Stack & Hang Bins **NEW**
- 5 Ultra Stack & Hang Bins **NEW**
- 6 Mesh Stack & Hang Bins **NEW**
- 7 Wire Louvered Panels
- 8 Louvered Panels
- 9 Louvered Panels & Bench Racks
- 10 Louvered Racks
- 11 Hanging Rail Systems
- 12 Complete Package Systems
- 13 Giant Open Hopper Steel Shelving Systems
- 14 Giant Open Hopper Wire Shelving Systems
- 15 Heavy-Duty 36" All-Welded Bin Cabinets
- 16 Heavy-Duty 36" & 48" Specialty Bin Cabinets
- 17 Heavy-Duty 48" All-Welded Bin Cabinets
- 18 Heavy-Duty 48" Cabinet & Rail Cart
- 19 Heavy-Duty 60" & 72" All-Welded Bin Cabinets

CLEAR-VIEW BINS

- 20 Ultra Bins & Shelving Systems **NEW**
- 21 Ultra Bin Systems
- 22 HULK 24" Containers & Shelving Systems **NEW**
- 23 Giant Stack Containers & Shelving Systems
- 24 Economy 4" Shelf Bins & Shelving Systems
- 25 Economy 4" Shelf Bin Shelving Systems
- 26 Store-More 6" Shelf Bins & Shelving Systems
- 27 Store-More 6" Shelf Bin Shelving Systems
- 28 Store-Max 8" Shelf Bins
- 29 Store-Max 8" Shelf Bin Shelving Systems
- 30 Genuine stack and nest totes **NEW**
- 31 Dividable Grid Containers & Shelving Systems **NEW**

BINS, TOTES & CONTAINERS

- 32 Stackable Shelf Bins
- 33 Stackable Shelf Bin Shelving Systems
- 34 HULK 24" Containers **NEW**
- 35 HULK 24" Container Steel Shelving Systems **NEW**
- 36 HULK 24" Container Wire Shelving Systems
- 37 HULK 30" & 36" Containers
- 38 HULK 30" Container Wire Shelving Systems
- 39 HULK 36" Container Wire Shelving Systems
- 40 Rackbin 42" Containers
- 41 Rackbin 42" Container Wire Shelving Systems
- 42 Giant Stack Containers
- 43 Giant Stack Container Storage Center
- 44 Giant Stack Container Wire Shelving Systems
- 45 MAGNUM Bins
- 46 MAGNUM Bin Steel Shelving Systems
- 47 MAGNUM Bin Wire Shelving Systems
- 48 Economy 4" Shelf Bins
- 49 Economy 4" Shelf Bin Steel Shelving Systems
- 50 Economy 4" Shelf Bin Sloped Shelving Systems
- 51 Economy 4" Shelf Bin Wire Shelving Systems
- 52 High Density Wire Shelving Systems
- 53 Store-More 6" Shelf Bins
- 54 Store-More 6" Shelf Bin Steel Shelving Systems
- 55 Store-More 6" Shelf Bin Sloped Shelving Systems
- 56 Store-More 6" Shelf Bin Wire Shelving Systems
- 57 Store-Max 8" Shelf Bins
- 58 Store-Max 8" Shelf Bin Steel Shelving Systems
- 59 Store-Max 8" Shelf Bin Wire Shelving Systems
- 60 Super Tuff Euro Drawers
- 61 Super Tuff Euro Drawer Steel Shelving Systems
- 62 Super Tuff Euro Drawer Sloped Shelving Systems

- 63 QuickPick Bins & Wire Shelving Systems
- 64 Latch Containers & Wire Shelving System **NEW**
- 65 Dividable Grid Containers **NEW**
- 66 Genuine stack and nest totes
- 67 Wire Shelving Systems
- 68 Cross Stack Tub & QuanTub Nesting Tote
- 69 Tub Racks **NEW**
- 70 Stacker Straight Wall Containers
- 71 Attached Top Distribution Containers
- 72 Collapsible Bulk Box
- 73 Removable Tray Trucks
- 74 MAGNUM Bin Transport Trucks
- 75 Polymer Utility Carts & Tool Rack
- 76 Tool Caddy & Box, Economy Nesting Bin, Wrench Holder **NEW**
- 77 Labels

SPECIALTY

- 78 Plastic Drawer Cabinets **NEW**
- 79 Organizers **NEW**
- 80 Clear Compartment Storage Boxes **NEW**
- 81 Recycled Bins **NEW**
- 82 Conductive Bins & Hanging Systems
- 83 Conductive Shelf Bins & Wire Shelving Systems
- 84 Conductive Dividable Grid Containers & Bin Carts **NEW**
- 85 Conductive Wire Utility Carts, Trays & Tray Carts
- 86 Computer Work Center, Reel & Stencil Shelving Units **NEW**
- 87 Clear Tip Out Bins
- 88 Dividable & Individual Clear Tip Out Bins & 669 Bin Set **NEW**
- 89 Clear Tip Out Bin Rails & Frames
- 90 Clear Tip Out Bin Floor Stands
- 91 Mobile Clear Tip Out Bin Floor Stands
- 92 Clear Tip Out Bin Free Standing & Gondola Slider Systems
- 93 Clear Tip Out Bin Cabinets, Cart & Spinner **NEW**
- 94 Interlocking Storage Cabinets
- 95 Interlocking Storage Cabinet Floor Stands
- 96 IRONMAN 22 Gauge Steel Shelving

WIRE

- 97 Wire Shelving System Finishes
- 98 Wire Shelves **NEW**
- 99 Posts & Solid Shelves **NEW**
- 100 54" Wire Shelving Units
- 101 63" Wire Shelving Units
- 102 74" Wire Shelving Units
- 103 86" Wire Shelving Units
- 104 Galvanized Steel Solid Shelving Units
- 105 Galvanized Steel Solid Shelving Units
- 106 Stainless Steel Solid Shelving Units
- 107 Stainless Steel Solid Shelving Units
- 108 Convenient 1 Box Chrome Wire Shelving Units
- 109 Wire Plastic Mat Shelving Units **NEW**
- 110 Corner Wire Shelving **NEW**
- 111 Reel Shelving Units **NEW**
- 112 PARTition Wall Systems
- 113 PARTition Wall Systems **NEW**
- 114 PARTition Wall Systems **NEW**
- 115 PARTition Wall Systems - Accessories **NEW**
- 116 Smart Grid Mounted Systems **NEW**
- 117 Smart Grid Mounted Systems - Accessories **NEW**
- 118 Wall Mount Cantilever Systems **NEW**
- 119 Wall Mount Cantilever Systems
- 120 Modular Wire Stacking Baskets
- 121 Wire Basket Units

- 122 Post Baskets & Mobile Units
- 123 Labels **NEW**
- 124 PARTition Store Pull Out Basket Carts
- 125 PARTition Store Pull Out Basket & Single Bay Carts
- 126 PARTition Store Double Bay Carts - Accessories
- 127 Shelves & Frames **NEW**
- 128 Dunnage & Platform Racks **NEW**
- 129 Dunnage & Platform Racks
- 130 Slanted Shelf Carts
- 131 Slanted Shelf Carts
- 132 Bin Carts
- 133 Double & Triple Bay Bin Carts
- 134 Utility Carts
- 135 Modular Trays & Tray Carts
- 136 Cart Covers
- 137 Stem Caster Carts
- 138 Enclosure Carts
- 139 Enclosure Carts
- 140 Enclosure Carts
- 141 Security Units **NEW**
- 142 High Density Sliding Floor Track System
- 143 High Density Sliding Floor Track System
- 144 High Density Sliding Overhead Track System
- 145 High Density Sliding Overhead Track System
- 146 Wire Shelving - Accessories **NEW**
- 147 Wire Shelving - Accessories **NEW**
- 148 Wire Shelving - Accessories **NEW**
- 149 Wire Shelving - Accessories

MEDICAL

- 150 Hamper & Sterile Wrap Carts
- 151 Stainless Steel Carts & Tables
- 152 Catheter Carts
- 153 Garment Racks & Patient Apparel Cart
- 154 Bin Transport Carts

- 155 Layout & Design Services
- 156 Index
- 157 Index
- 158 Index
- 159 Index



Product video(s) available online when you see this icon throughout our catalog!

The most efficient, permanent, and economical solution to solve your exact storage needs!

ULTRA BINS & SYSTEMS



Ultra Stack & Hang Bins
4-5



Mesh Stack & Hang Bins
6



Wire Louvered Panels
7



Louvered Panels
8



Louvered Panels & Bench Racks
9



Louvered Racks, Rails & Complete Systems
10-12



Giant Open Hopper Steel Shelving Systems
13



Giant Open Hopper Wire Shelving Systems
14



Cabinets & Rail Cart
15-19

CLEAR-VIEW BINS



Ultra Bins & Shelving Systems
20



Ultra Bin Systems
21



Hulk 24" Containers & Shelving Systems
22



Giant Stack Containers & Shelving Systems
23



Economy 4" Shelf Bins & Shelving Systems
24-25



Store-More 6" Shelf Bins & Shelving Systems
26-27



Store-Max 8" Shelf Bin & Shelving Systems
28-29



stack and nest totes & Shelving Systems
30



Dividable Grid Containers & Systems
31

BINS, TOTES & CONTAINERS



Stackable Shelf Bins & Shelving Systems
32-33

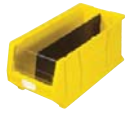

Hulk 24" Containers & Shelving Systems
34-36



Hulk 30" & 36" Containers & Shelving Systems
37-39



RackBin 42" Containers & Shelving Systems
40-41



Giant Stack Containers & Shelving Systems
42-44



Magnum Bins & Shelving Systems
45-47



Economy 4" Shelf Bins & Shelving Systems
48-52

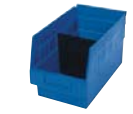

Store-More 6" Shelf Bins & Shelving Systems
53-56



Store-Max 8" Shelf Bins & Shelving Systems
57-59



Super Tuff Euro Drawers & Shelving Systems
60-62



Latch & Dividable Grid Containers
64-65



Genuine Stack & Nest Totes & Wire Systems
66-67



Cross Stack Tubs, QuanTub & Racks
68-69



Stacker Straight Wall Containers
70



Attached Top Distribution Containers
71



Collapsible Bulk Box
72



Removable Tray & Bin Transport Trucks
73-74



Polymer Utility Carts & Tool Rack
75

SPECIALTY



Plastic Drawer Cabinets
78



Organizers & Storage Boxes
79-80



Recycled Bins
81



Conductive Bins, Trays, Systems & Carts
82-85



Work Center, Reel & Stencil Shelving Units
86

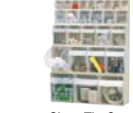

Clear Tip Out Bins
87-89



Clear Tip Out Bin Floor Stands & Gondolas
90-92



Clear Tip Out Bin Cabinets, Cart & Spinner
93



Interlocking Cabinets, Floor Stands & Steel Shelving
94-96

WIRE



Wire & Solid Shelves and Posts
97-99



Wire Shelving Units
100-103



Solid Galvanized Shelving Units
104-105



Stainless Steel Shelving Units
106-107



One Box & Plastic Mat Shelving Units
108-109



Corner Shelving Units
110



Reel Shelving Units
111



PARTITION Wall Systems
112-115



Smart Grid Mount System
116-117



Wall Mount Systems
118-119



Wire Basket Units
120-121



Post Baskets & Mobile Units
122



Labels
123



PARTITION Store Carts
124-126



Shelves & Frames
127



Dunnage & Platform Racks
128-129



Slanted Shelf Carts
130-131



Bin Carts
132-133

MEDICAL



Utility Carts
134



Modular Trays & Carts
135



Cart Covers & Carts
136-141



Sliding Floor Track Systems
142-143



Sliding Overhead Track Systems
144-145



Wire Shelving Accessories
146-149



Hamper, Sterile Wrap & Stainless Carts & Tables
150-151



Catheter Carts
152



Garment Racks & Carts
153-154

Ultra Stack & Hang Bins



PERFORMANCE FEATURES:

- Available in 23 sizes
- Standard colors: Blue, Green, Ivory, Red, Yellow, Black and Clear
Pink and Stone color are available in select sizes
(additional colors available on request, subject to upcharge and minimum run quantity)
- Bins are made from heavy-duty, virgin grade, high density FDA approved polypropylene
- Large label slot provide easy label insertion and parts' identification
- Extra wide stacking ledge ensures stability for high stacking
- Reinforced design adds strength and prevents spreading of side walls
- Will not rust or corrode, unaffected by weak acids and alkalis, and are waterproof
- Autoclavable up to 250°F
- Interchangeable with other manufactured brands of bins

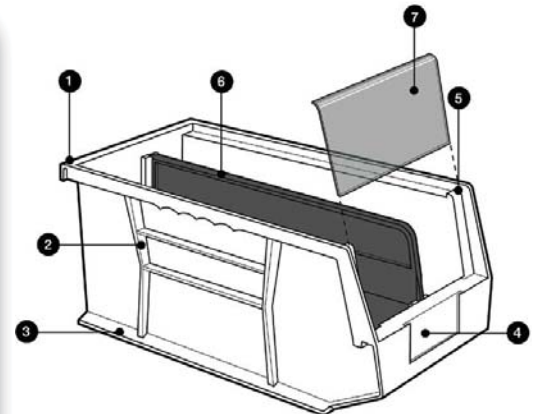

- 1 Full width hanger supports bin when hanging from louvered panels or rails
- 2 Reinforced rib design adds strength and prevents spreading of side walls
- 3 Extra-wide stacking ledge for secure stacking
- 4 Large front label slot allows larger bar code scanning and content identification
- 5 Anti-slide stop prevents stacked bins from shifting forward
- 6 Optional dividers increase storage options
- 7 Optional windows maximize storage capacity, prevent spillage and protect parts from dust and dirt

NEW CLEAR DIVIDERS



QUS230 with COV230

Lid pivots up and down via insertion in holes in rear of bin
(Sold separately)



QUS239CL and QUS240

Shown with optional clear window front and dividers in clear or black
(Sold separately)



MOBILE ULTRA BIN

Ideal for transport of heavy and bulky parts. Bin comes with 4 swivel, 3" polyurethane casters, all with brakes, allowing up to 250 lb. mobile load capacity

CLEAR LABEL HOLDER

Clear label holders and laser label inserts slide into front label slot of all bins.
(Sold in packages of 25)



POLYMER DOLLY

DLY-3018 Dolly with padded rubber trim, available in Blue. Dimensions 30"L x 18"W. Set of four 4" x 1-1/4" non-marking swivel poly casters, 1,000 lb. load capacity.
(Bin sold separately)



ATTACHED PULL RING

Allows dolly to be pulled with ease



MODEL NO.	DESCRIPTION	CTN WGT
DLY-3018	Dolly with Padded Rubber Trim	19 lbs
HANDLE-DLY	32" Dolly Pull Rod with Handle	2 lbs

Bins sold separately



32" Dolly Pull Rod with handle
Finish: Chrome



23 SIZES AND 9 COLORS AVAILABLE THE LARGEST SELECTION ANYWHERE



AVAILABLE on pg. 20



NEW SIZES

QUS245 Shown with optional Clear Window and Black Divider

QUS250

QUS270 Shown with optional Clear Window

NEW QUS232

NEW QUS236

HEAVY-DUTY LIFETIME USE

Bin Dimensions Guide
L (length) W (width) H (height)
X (inside bottom length)

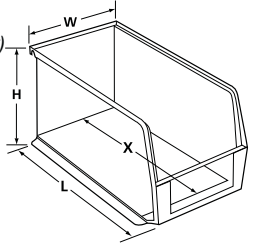

Ultra Stack & Hang Bins



Organize your inventory with these strong bins, manufactured with FDA approved materials. Front, back and side grips for easy handling. Built-in rear hanger allows bins to hang from louvered panels or rails. Optional clear injection molded crystal styrene window front increases bin capacity and provides quick view of bin contents. Dividers, available in black or clear, maximize flexibility and keep contents organized. Wide stacking ledge and anti-slide lock keep stacked bins steady and prevent forward shifting. Water, rust, and corrosion proof. Easily cleaned with soap and water and impervious to most chemicals. Large molded front label slots for ID labels. Autoclavable up to 250°F and resistant to extreme cold. Guaranteed not to break or crack under normal load conditions. See **pg. 20** to order Clear Bins.

Available in: ● Blue ● Green ● Ivory ● Red ● Yellow ● Black ● Clear

QUS210, QUS220, QUS224, QUS230, QUS234, QUS240, QUS250, QUS265, QUS270 also available in: ● Stone ● Pink
QUS210, QUS230, QUS240, QUS250 also available in: ● Pink

MODEL NO.	OUTSIDE DIMENSIONS L" x W" x H"	INSIDE DIMENSIONS L" x W" x H"	X"	CTN QTY	CTN WGT	BIN LOAD CAPACITY*	CLEAR WINDOW	CTN QTY	***DIVIDER & CROSS DIVIDER	CTN QTY	DIVIDER SLOTS	CLEAR LABEL HOLDER & INSERT	CLEAR LID	CTN QTY
QUS200	5" x 4-1/8" x 3"	4-3/8" x 3-7/16" x 2-13/16"	3-1/2"	24	5 lbs	13 lbs	-	-	DUS200	6	1	LTR-1300	-	-
QUS210	5-3/8" x 4-1/8" x 3"	4-3/4" x 3-7/16" x 2-13/16"	4"	24	6 lbs	15 lbs	-	-	DUS210	6	1	LTR-1300	COV210	24
QUS220	7-3/8" x 4-1/8" x 3"	6-3/4" x 3-7/16" x 2-13/16"	6"	24	8 lbs	15 lbs	-	-	DUS220	6	1	LTR-1300	COV220	24
QUS221	9-1/4" x 6" x 5"	8-1/2" x 5-1/8" x 4-1/2"	7-1/4"	12	6 lbs	25 lbs	WUS221	12	DUS221	6	1	LTR-1754	-	-
QUS224	10-7/8" x 4-1/8" x 4"	10-1/4" x 3-3/16" x 3-3/4"	9"	12	8 lbs	35 lbs	WUS224	12	DUS224	6	1	LTR-1253	COV224	12
QUS230	10-7/8" x 5-1/2" x 5"	10-1/4" x 4-3/8" x 4-3/4"	9"	12	10 lbs	35 lbs	WUS230/234	12	DUS230/235	6	1	LTR-1754	COV230	12
QUS232 NEW	5-3/8" x 11" x 3"	4-3/4" x 10-1/8" x 2-13/16"	4"	8	5 lbs	35 lbs	-	-	DUS210	6	3	LTR-1300	COV232	8
QUS234	14-3/4" x 5-1/2" x 5"	14-1/16" x 4-3/8" x 4-3/4"	12-13/16"	12	14 lbs	55 lbs	WUS230/234	12	DUS234	6	1	LTR-1754	-	-
QUS235	10-7/8" x 11" x 5"	10-1/4" x 10" x 4-3/4"	9"	6	10 lbs	55 lbs	WUS235	6	DUS230/235	6	3	LTR-1754	COV235	6
QUS236 NEW	7-3/8" x 11" x 3"	6-3/4" x 10-1/8" x 2-13/16"	6"	8	9 lbs	35 lbs	-	-	DUS220	6	3	LTR-1300	COV236	8
QUS238 NEW	18" x 5-1/2" x 5"	17-1/8" x 4-3/8" x 4-3/4"	15-7/8"	12	16 lbs	45 lbs	WUS230/234	12	DUS238 CRDUS238	6	1	LTR-1754	COV238	12
QUS239	10-3/4" x 8-1/4" x 7"	10" x 6-9/16" x 6-3/4"	8"	6	10 lbs	55 lbs	WUS239/240	6	DUS239	6	1	LTR-1754	COV239	6
QUS240	14-3/4" x 8-1/4" x 7"	14" x 6-9/16" x 6-3/4"	12"	12	24 lbs	65 lbs	WUS239/240	6	DUS240/250	6	1	LTR-1754	COV240	12
QUS241	13-5/8" x 8-1/4" x 6"	12-1/2" x 6-3/4" x 5-3/8"	11-1/8"	12	22 lbs	65 lbs	WUS241	12	DUS241	6	1	LTR-1754	-	-
QUS242	13-5/8" x 8-1/4" x 8"	12-1/2" x 6-3/4" x 7-3/8"	11-1/8"	12	25 lbs	65 lbs	WUS242	12	DUS242	6	1	LTR-1754	-	-
QUS245	10-7/8" x 16-1/2" x 5"	9-3/4" x 15" x 4-3/4"	9"	6	13 lbs	65 lbs	WUS245	6	DUS245	6	3	LTR-1754	-	-
QUS248 NEW	18" x 8-1/4" x 7"	17" x 6-1/2" x 6-1/2"	15-1/4"	6	19 lbs	80 lbs	WUS239/240	6	DUS248 CRDUS248	6	1	LTR-1754	COV248	6
QUS250	14-3/4" x 16-1/2" x 7"	14" x 14-3/4" x 6-3/4"	12"	6	21 lbs	80 lbs	WUS250	6	DUS240/250	6	3	LTR-1754	-	-
QUS255	16" x 11" x 8"	15-1/8" x 10" x 7-3/4"	11-5/8"	4	14 lbs	80 lbs	WUS255	4	DUS255	6	3	LTR-1754	-	-
QUS260	18" x 11" x 10"	17" x 9-1/2" x 9-3/4"	14-3/16"	4	17 lbs	80 lbs	WUS260	4	DUS260	6	3	LTR-1754	-	-
QUS265	18" x 8-1/4" x 9"	17-1/8" x 6-3/4" x 8-1/4"	14-1/2"	6	17 lbs	65 lbs	WUS265	6	DUS265	6	1	LTR-1754	-	-
QUS270	18" x 16-1/2" x 11"	17-1/8" x 14-3/4" x 10-1/4"	14"	3	16 lbs	80 lbs	WUS270	3	DUS270 CRDUS270	6	3	LTR-2400	-	-
QUS275MOB	18" x 16-1/2" x 11"***	17-1/8" x 14-3/4" x 10-1/4"	14"	3	25 lbs	-	WUS270	3	DUS270 CRDUS270	6	3	LTR-2400	-	-

*When attached to panels or rails **With casters, overall height is 14" ***For clear dividers add CL suffix to divider Model No. DUS200CL

12 SIZES AVAILABLE



Exclusive! Mesh Stack & Hang Bins



New patented wire Mesh Bins are an industry exclusive. Our innovative mesh design offers a bright-chrome finish and a 3/8" x 3/8" grid pattern allowing complete visibility of the bin's contents. This unique mesh pattern provides a dust and dirt free storage environment. Ultra strong design allows for superior hang capacity perfect for industrial parts storage or anything where hang capacities are vital. Quantum's Mesh Bins feature a rear hanger that allows them to hang from any louvered wall panel or rail system and optional side stacking ledge which allow bins to stack one on top of the other. The open hopper design allows for easy picking while allowing visual access to stored contents. Two styles of optional label holders are available for all Mesh Bins. **Finish:** Chrome

MODEL NO.	OUTSIDE DIMENSIONS L" x W" x H"	INSIDE DIMENSIONS L" x W" x H"	CTN QTY	CTN WGT	SIDE STACKING LEDGE SOLD PER PAIR	DIVIDER
QMB510C	5-1/4" x 4-1/4" x 3"	4-3/4" x 3" x 2-3/4"	20	12 lbs	HMB510C	DMB510C
QMB520C	7-1/4" x 4-1/4" x 3"	6-3/4" x 3" x 2-3/4"	20	15 lbs	HMB520C	DMB520C
QMB524C NEW	11" x 4-3/4" x 4"	10-3/8" x 3-1/2" x 3-3/4"	10	15 lbs	HMB530C/535C	DMB524C
QMB530C	10-3/4" x 5-1/2" x 5"	10-1/4" x 4" x 4-3/4"	10	12 lbs	HMB530C/535C	DMB530C/535C
QMB534C NEW	15" x 6" x 5"	14-1/4" x 4-3/4" x 4-3/4"	10	17 lbs	HMB540C/550C	DMB534C
QMB535C	10-3/4" x 11" x 5"	10-1/4" x 9-3/4" x 4-3/4"	10	19 lbs	HMB530C/535C	DMB530C/535C
QMB539C	10-1/2" x 8" x 7"	10" x 6-5/8" x 6-5/8"	10	20 lbs	HMB539C	DMB539C
QMB540C	14-1/2" x 8" x 7"	14" x 6-5/8" x 6-5/8"	10	30 lbs	HMB540C/550C	DMB540C/550C
QMB550C	14-1/2" x 16-1/4" x 7"	14" x 14-7/8" x 6-5/8"	5	17 lbs	HMB540C/550C	DMB540C/550C
QMB560C	18-1/2" x 11" x 10-1/8"	18" x 9-5/8" x 9-7/8"	5	21 lbs	HMB560C/570C	DMB560C/570C
QMB565C NEW	17-3/4" x 8-1/8" x 9"	17-1/8" x 5-1/4" x 8-3/4"	5	19 lbs	HMB565C	DMB565C
QMB570C	18-1/2" x 17-1/8" x 11-1/8"	18" x 15-5/8" x 10-7/8"	5	28 lbs	HMB560C/570C	DMB560C/570C

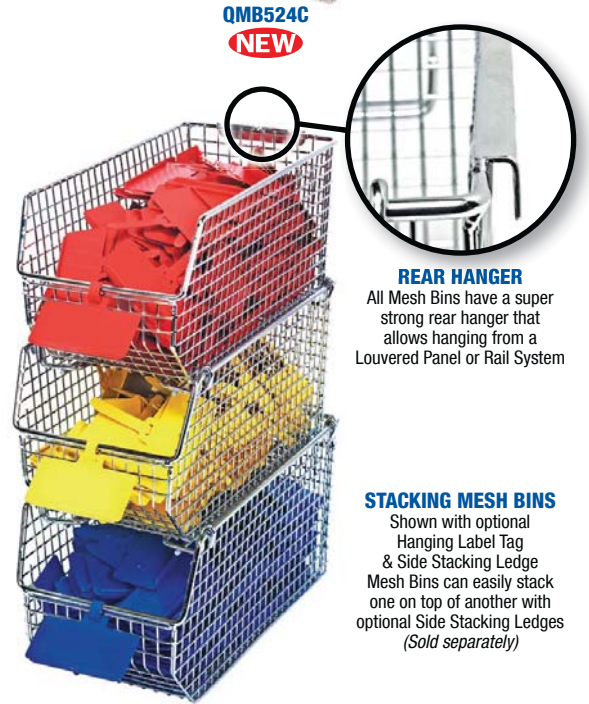

REAR HANGER

All Mesh Bins have a super strong rear hanger that allows hanging from a Louvered Panel or Rail System

STACKING MESH BINS

Shown with optional Hanging Label Tag & Side Stacking Ledge Mesh Bins can easily stack one on top of another with optional Side Stacking Ledges (Sold separately)

2 LABEL HOLDER OPTIONS



Shown with optional Divider (Sold separately)



Shown with optional Side Stacking Ledge Pair (Sold separately)

Accessories

INSTANT VISIBILITY
NO DUST OR DIRT
BUILDUP
ALL WELDED



Shown with optional HBL3C Clear Label Holder Fits 1-1/8" x 3" Label (Sold separately)



Shown with optional PS-LH3 Hanging Label Tag Fits 1-3/8" x 3" Label

- Clear
 - Red
 - Yellow
 - Blue
 - Green
 - Orange
 - Pink
 - Purple
- (Sold separately)

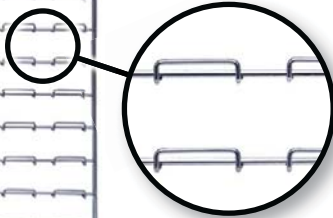
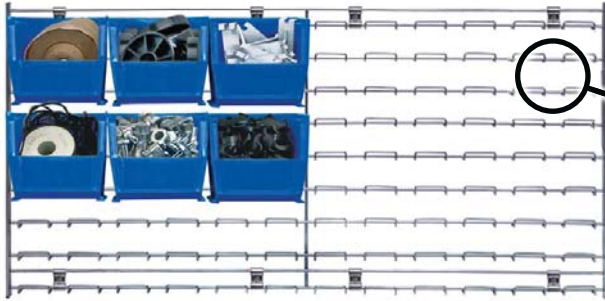

WLP-1836C

36" L x 18" H
Accepts all sizes of Ultra Stack & Hang Bins and Mesh Bins. Includes 8 direct mount clips. 175 lb. load capacity.

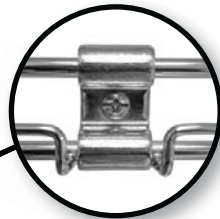

WLP-3036C

36" L x 30" H
Accepts all sizes of Ultra Stack & Hang Bins and Mesh Bins. Includes 12 direct mount clips. 250 lb. load capacity.

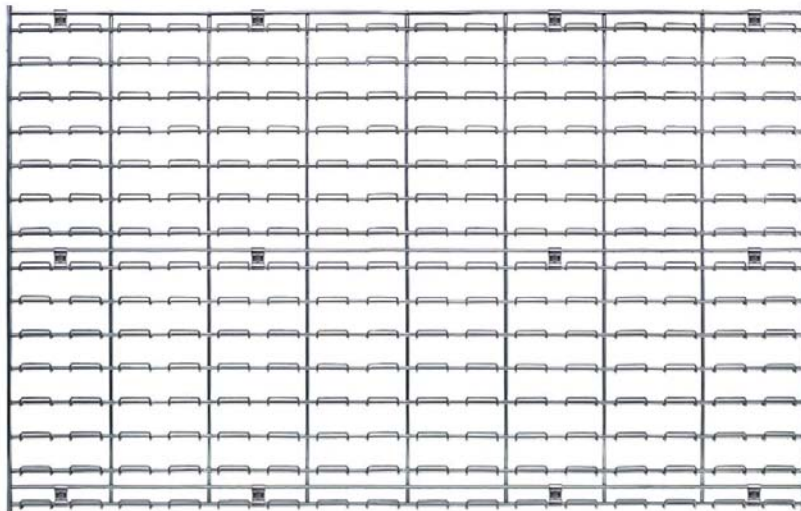

Exclusive! Wire Louvered Panels



Quantum's chrome Wire Louvered Panels offer a perfect mounting solution for all plastic hanging and wire mesh hanging bins. Quantum's exclusive offering of wire panels, available in three sizes, completely resist any buildup of dust or dirt. Included direct mounting clips enable fastening to any surface (*wall, wood, concrete, drywall, etc.*) a snap (*note: mounting screws are not included as they differ based on what type of surface the panels are being mounted to*). Offset mounting clips are also available, can be used in place of **WLP-DMC** if you want to have wire panel mounted offset (*away*) from a wall surface making it easier to clean behind the panel (*sold separately*). Manufactured of heavy-duty chrome wire, Quantum's wire panels will offer years of dependable and heavy-duty service.

MODEL NO.	DIMENSIONS L" x H"	CTN QTY	CTN WGT
Wire Wall Mounted Louvered Panels			
WLP-1836C	36" x 18" Wire Louvered Panel	1	12 lbs
WLP-3036C	36" x 30" Wire Louvered Panel	1	19 lbs
WLP-3048C	48" x 30" Wire Louvered Panel	1	26 lbs

Accessories



WLP-DMC

Direct Mount Clips - 4 pack

(Included with wire louvered panels)

Extra packages available (if needed). (Sold separately)



WLP-OSC

Offset Mount Clips - 4 pack

Offsets panel from wall surface allowing easy access to clean behind panel (Sold separately)

WLP-3048C

48" L x 30" H

Accepts all sizes of Ultra Stack & Hang Bins and Mesh Bins. Includes 12 direct mount clips. 300 lb. load capacity.

**SIMPLE TO MOUNT
EASY TO CLEAN
ALL WELDED**

MODEL NO.	QUANTITY OF MESH BINS TO FIT LOUVERED PANELS												QUANTITY OF ULTRA BINS TO FIT LOUVERED PANELS																					
	QMB 510	QMB 520	QMB 524	QMB 530	QMB 534	QMB 535	QMB 539	QMB 540	QMB 550	QMB 560	QMB 565	QMB 570	QUS 200	QUS 210	QUS 220	QUS 221	QUS 224	QUS 230	QUS 232	QUS 234	QUS 235	QUS 236	QUS 238	QUS 239	QUS 240	QUS 241	QUS 242	QUS 245	QUS 248	QUS 250	QUS 255	QUS 260	QUS 265	QUS 270
WLP-1836C	32	32	18	18	18	9	8	8	4	3	4	2	32	32	32	18	18	18	12	18	9	12	18	8	8	8	8	6	8	4	6	3	4	2
WLP-3036C	56	56	30	30	30	15	16	16	6	6	8	6	56	56	56	30	30	30	21	30	15	21	30	16	16	16	16	10	16	6	9	6	8	6
WLP-3048C	77	77	40	40	40	20	20	20	8	12	15	6	77	77	77	40	40	40	28	40	20	28	40	20	20	20	20	10	20	8	12	12	15	6

See pgs. 5 & 6 for bin dimensions



Hanging Louvered Panels



Quantum Ultra and Mesh Bins will hang on louvered panels in a wide range of configurations designed to meet all application needs. Panels are formed from heavy-duty 16 gauge cold rolled steel and have a Gray or Oyster White powder coat finish which ensures years of heavy-duty use. Louvered panels may be mounted on any suitable wall surface. Fasten securely to assure adequate load bearing. Mounting hardware is not included.

MODEL NO.	DIMENSIONS L" x H"	CTN QTY	CTN WGT
Gray Wall Mounted Louvered Panels			
QLP-1819	18" x 19" Gray Louvered Panel	1	6 lbs
QLP-1861	18" x 61" Gray Louvered Panel	1	21 lbs
QLP-2721	27-3/4" x 21" Gray Louvered Panel	1	11 lbs
QLP-3612	36" x 12" Gray Louvered Panel	1	8 lbs
QLP-3619	36" x 19" Gray Louvered Panel	1	13 lbs
QLP-3661	36" x 61" Gray Louvered Panel	1	40 lbs
QLP-4819	48" x 19" Gray Louvered Panel	1	18 lbs
QLP-4861	48" x 61" Gray Louvered Panel	1	60 lbs
Oyster White Wall Mounted Louvered Panels			
QLP-1819HC	18" x 19" Oyster White Louvered Panel	1	6 lbs
QLP-1861HC	18" x 61" Oyster White Louvered Panel	1	21 lbs
QLP-3619HC	36" x 19" Oyster White Louvered Panel	1	13 lbs
QLP-3661HC	36" x 61" Oyster White Louvered Panel	1	40 lbs
QLP-4861HC	48" x 61" Oyster White Louvered Panel	1	60 lbs



QLP-1819
18"L x 19"H

Accepts all sizes of Ultra and Mesh Bins. 175 lb. load capacity. (Bins sold separately)

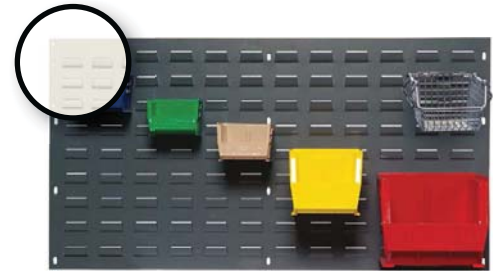

QLP-3619
36"L x 19"H

Accepts all sizes of Ultra and Mesh Bins. 200 lb. load capacity. (Bins sold separately)



QLP-1861
18"L x 61"H

Accepts all sizes of Ultra and Mesh Bins. 500 lb. load capacity. (Bins sold separately)



QLP-3612
36"L x 12"H

Accepts all sizes of Ultra and Mesh Bins. 175 lb. load capacity. (Bins sold separately)



QLP-4861
48"L x 61"H

Accepts all sizes of Ultra and Mesh Bins. 1,000 lb. load capacity.

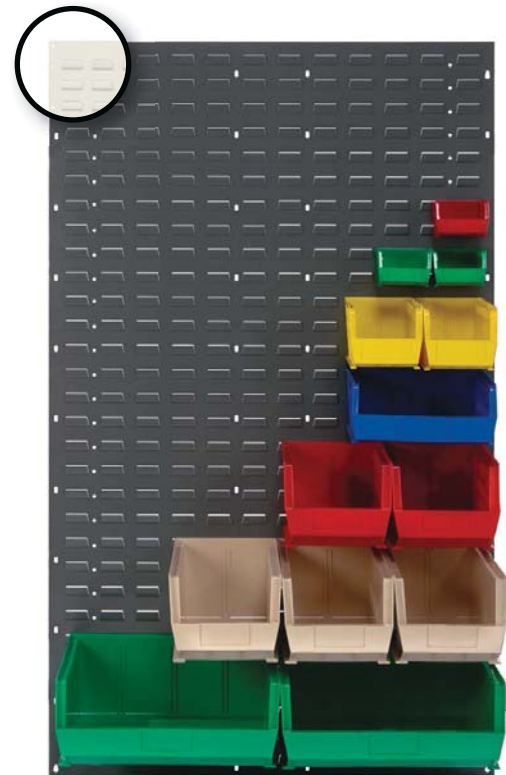

QLP-3661
36"L x 61"H

Accepts all sizes of Ultra and Mesh Bins. 1,000 lb. load capacity. (Bins sold separately)



QLP-4819
48"L x 19"H

Accepts all sizes of Ultra and Mesh Bins. 250 lb. load capacity. (Bins sold separately)

OFFERED IN GRAY OR OYSTER WHITE COLOR

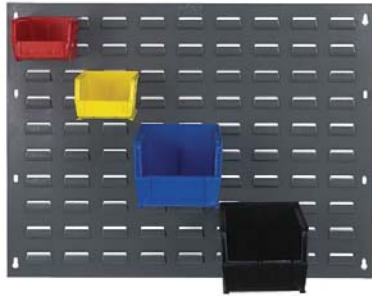

QLP-2721
27-3/4" L x 21" H
Accepts all sizes of Ultra and Mesh Bins.
175 lb. load capacity. (Bins sold separately)



QBR-3619
36" L X 8" W x 19" H
Accepts all sizes of Ultra and Mesh Bins.
150 lb. load capacity. (Bins sold separately)



QBR-3612
36" L X 8" W x 12" H
Accepts all sizes of Ultra and Mesh Bins.
125 lb. load capacity. (Bins sold separately)



QBR-1819
18" L X 8" W x 19" H
Accepts all sizes of Ultra and Mesh Bins.
140 lb. load capacity. (Bins sold separately)

Accessories



WS-SR9C
9" Single Rod
15 lb. load capacity



WS-DR10C
10" Double Rod
15 lb. load capacity



WS-VTH
Vertical Tape/Reel Holder
25 lb. load capacity

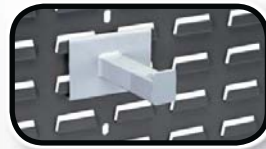

WS-HDS6
Heavy-Duty 6" Spike
65 lb. load capacity



WS-HDS12
Heavy-Duty 12" Spike
50 lb. load capacity



SLP-1236 (12" D x 36" W) and SLP-1836 (18" D x 36" W)
Flat Shelf with 2 Brackets. Available in 12" or 18" Depth.
75 lb. load capacity

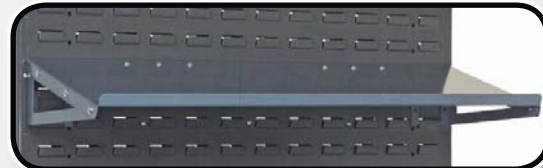

SLP-A1236 (12" D x 36" W) and SLP-A1836 (18" D x 36" W)
Slanted Shelf with 2 Slanted Brackets. Available in 12" or 18" Depth.
75 lb. load capacity



WS-HTH
Horizontal Tape/Reel Holder
25 lb. load capacity

Bench Racks

CUSTOMIZE YOUR OWN UNIT

1. Select the hanging unit of your choice.
2. Turn to pg. 5 and pg. 6 to choose the bin that best fits your need.
3. Go to the chart at the bottom of this page and determine how many bins fit on the unit you selected.
4. Place your order for both unit and bins.

MODEL NO.	DIMENSIONS L" x W" x H"	CTN QTY	CTN WGT
QBR-1819	18" x 8" x 19" Bench Rack	1	11 lbs
QBR-2721	27-3/4" x 8" x 21" Bench Rack	1	16 lbs
QBR-3612	36" x 8" x 12" Bench Rack	1	14 lbs
QBR-3619	36" x 8" x 19" Bench Rack	1	19 lbs

MODEL NO.	QUANTITY OF MESH BINS TO FIT LOUVERED PANELS												QUANTITY OF ULTRA BINS TO FIT LOUVERED PANELS																						
	QMB 510	QMB 520	QMB 524	QMB 530	QMB 534	QMB 535	QMB 539	QMB 540	QMB 550	QMB 560	QMB 565	QMB 570	QUS 200	QUS 210	QUS 220	QUS 221	QUS 224	QUS 230	QUS 232	QUS 234	QUS 235	QUS 236	QUS 238	QUS 239	QUS 240	QUS 241	QUS 242	QUS 244	QUS 245	QUS 248	QUS 250	QUS 255	QUS 260	QUS 265	QUS 270
QLP-1819	16	16	12	9	9	3	4	4	2	1	4	1	16	16	16	9	12	9	6	9	3	6	9	4	4	4	4	4	3	4	2	1	1	4	1
QLP-1861	60	60	30	30	30	15	14	14	7	5	12	5	60	60	60	30	30	30	15	30	15	15	30	14	14	14	14	10	4	7	7	5	12	5	
QLP-2721	30	30	12	12	12	6	6	6	2	4	6	1	30	30	30	12	12	12	10	12	6	10	12	6	6	6	6	3	14	2	4	4	6	1	
QLP-3612	18	18	12	12	12	6	4	4	2	3	8	2	18	18	18	12	12	12	9	12	6	9	12	4	4	4	4	6	2	6	3	8	2		
QLP-3619	40	40	24	18	18	9	8	8	4	3	8	2	40	40	40	18	24	18	12	18	9	12	18	8	8	8	6	4	4	6	3	8	2		
QLP-3661	120	120	80	60	60	30	28	28	14	15	24	10	120	120	120	60	80	60	45	60	30	45	60	28	28	28	28	20	8	14	21	15	24	10	
QLP-4819	55	55	24	24	24	12	10	10	4	8	10	2	55	55	55	24	24	24	16	24	12	16	24	10	10	10	10	6	28	4	8	8	10	2	
QLP-4861	165	165	80	80	80	40	35	35	14	20	30	10	165	165	165	80	80	80	60	80	40	60	80	35	35	35	20	10	14	28	20	30	10		
QBR-1819	16	16	12	9	9	3	4	4	2	1	4	1	16	16	16	9	12	9	6	9	3	6	9	4	4	4	3	35	2	1	1	4	1		
QBR-2721	30	30	12	12	12	6	6	6	2	4	6	1	30	30	30	12	12	12	10	12	6	10	12	6	6	6	6	3	6	2	4	4	6	1	
QBR-3612	18	18	12	12	12	6	4	4	2	3	8	2	18	18	18	12	12	12	9	12	6	9	12	4	4	4	4	4	4	2	6	3	8	2	
QBR-3619	32	32	32	18	18	9	8	8	4	3	8	2	32	32	32	18	32	18	12	18	9	12	18	8	8	8	8	6	8	4	6	3	8	2	

See pgs. 5 & 6 for bin dimensions



QSS-3666H
Single Sided Louvered Rack

36"L x 12-1/2"W x 66"H
800 lb. capacity. Single sided unit accepts all sizes of Ultra and Mesh Bins (up to 120 bins)
Shown with QUS240 and QUS250 bins.
(Bins sold separately)



QDS-3666H
Double Sided Louvered Rack

36"L x 25"W x 66"H
2,000 lb. capacity. Mobile unit accepts all sizes of Ultra and Mesh Bins (up to 240 bins)
Shown with QUS235 bins.
(Bins sold separately)



QMD-36H
Mobile Double Sided Louvered Rack

36"L x 25"W x 72"H
1,200 lb. capacity. Mobile unit accepts all sizes of Ultra and Mesh Bins (up to 240 bins). Comes complete with four 5" hard rubber, heavy-duty casters, 2 swivel with brake and 2 rigid. Easy-to-pull handle included.
Shown with QUS230 and QUS240 bins.
(Bins sold separately)



QSS-1866H
Single Sided Louvered Rack

18"L x 12-1/2"W x 66"H
375 lb. capacity. Single sided unit accepts all sizes of Ultra and Mesh Bins (up to 60 bins).
Shown with QUS245 bins.
(Bins sold separately)

Slanted Shelf
see pg. 9

Flat Shelf
see pg. 9

Wire Mesh Bins
see pg. 6

Plastic Bins
see pg. 5



CUSTOMIZE YOUR OWN UNIT

1. Select the hanging unit of your choice.
2. Turn to pg. 5 and pg. 6 to choose the bin that best fits your need.
3. Go to the chart at the bottom of this page and determine how many bins fit on the unit you selected.
4. Place your order for both unit and bins.

Louvered Racks



MODEL NO.	BIN DIMENSIONS L" x W" x H"	CTN QTY	CTN WGT
Single Sided Unit - 375 lb. Capacity			
QSS-1866H	18"L x 12-1/2"W x 66"H	1	40 lbs
Single Sided Unit - 800 lb. Capacity			
QSS-3666H	36"L x 12-1/2"W x 66"H	1	60 lbs
Double Sided Unit - 2,000 lb. Capacity			
QDS-3666H	36"L x 25"W x 66"H	1	106 lbs
Double Sided Unit - Mobile Unit - 1,200 lb. Capacity			
QMD-36H	36"L x 25"W x 72"H	1	155 lbs

QUANTITY OF ULTRA BINS TO FIT LOUVERED RACKS

MODEL NO.	QUS 200	QUS 210	QUS 220	QUS 221	QUS 224	QUS 230	QUS 232	QUS 234	QUS 235	QUS 236	QUS 238	QUS 239	QUS 240	QUS 241	QUS 242	QUS 245	QUS 248	QUS 250	QUS 255	QUS 260	QUS 265	QUS 270
QSS-1866H	60	60	60	30	30	30	15	30	10	15	30	15	14	14	14	10	14	10	7	5	12	5
QSS-3666H	120	120	120	60	80	60	45	60	30	45	60	28	28	28	24	20	28	14	21	15	24	10
QDS-3666H	240	240	240	120	160	120	90	120	60	90	120	56	56	48	40	28	56	42	30	40	40	20
QMD-36H	240	240	240	120	160	120	90	120	60	90	120	56	56	48	40	28	56	42	30	40	40	20

See pg. 5 for bin dimensions



Hang-n-Stack Bins - Complete Packages

Comes with 2 handy 12" plastic rails ideal for mounting to any surface. Bins can hang or stack securely providing an efficient bin storage system. Bins available in Blue, Yellow, Red, Green, Ivory, Black and Clear. Rails available in White.

CUSTOMIZE YOUR OWN UNIT

1. Select the hanging unit of your choice.
2. Turn to pg. 5 and choose the bin that best fits your need.
3. Go to the chart at the bottom of this page and determine how many bins fit on the unit you selected.
4. Place your order for both unit and bins.

Ultra Rail Systems



Rails may be mounted on any suitable surface including walls, benches, inside service trucks and cabinets or on carts. Fasten securely to ensure proper load bearing. Configure Rail to meet your custom requirements. Mounting hardware is not included. (Bins sold separately)



Steel Rail

NEW
OYSTER WHITE
COLOR

48"L x 5/8"W x 3"H Steel Rail mounts to any surface or workbench and accepts 13 sizes of Ultra bins (up to 11 bins per rail). 125 lb. load capacity. Gray powder coat and oyster white finish.

MODEL NO.	BIN DIMENSIONS L" x W" x H"	DESCRIPTION	CTN WGT
HNS200	5" x 4-1/8" x 3"	6 bins + 2 rails	2 lbs
HNS210	5-3/8" x 4-1/8" x 3"	6 bins + 2 rails	2 lbs
HNS220	7-3/8" x 4-1/8" x 3"	6 bins + 2 rails	3 lbs
HNS230	10-7/8" x 5-1/2" x 5"	4 bins + 2 rails	5 lbs
HNS006	Extra Rails	2 rails	1 lb

MODEL NO.	DESCRIPTION	CTN QTY	CTN WGT
QRU-1W	48" Wall Rail	1	6 lbs
QRU-1WHC	48" Wall Rail Oyster White	1	6 lbs



Shown with 24 QUS240 bins. (Bins sold separately)

QRU-12S

Single Sided Rack, 12 Rails

36"L x 15"W x 53"H
600 lb. capacity. Accepts 12 sizes of Ultra Bins (up to 96 bins). See chart for bin configurations.

QRU-16S

Single Sided Rack, 16 Rails

600 lb. capacity. Accepts 6 sizes of Ultra Bins (up to 48 bins). See chart for bin configurations.



Shown with 192 QUS220 bins. (Bins sold separately)

QRU-12D

Double Sided Rack, 12 Rails

36"L x 20"W x 53"H
1,600 lb. capacity. Accepts 12 sizes of Ultra Bins (up to 192 bins). See chart for bin configurations.

QRU-16D

Double Sided Rack, 16 Rails

Accepts 6 sizes of Ultra Bins (up to 96 bins)
1,600 lb. capacity. See chart for bin configurations.



Shown with 96 QUS230 bins. (Bins sold separately)

QRU-16D + QRU-MOB

Double Sided Rack, 16 Rails with Mobile Kit

36"L x 20"W x 59"H
2 rigid, 1 swivel and 1 swivel with brake casters
1,000 lb. capacity. Accepts 6 sizes of Ultra Bins (up to 96 bins). See chart for bin configurations.

QRU-12D + QRU-MOB

Double Sided Rack, 12 Rails with Mobile Kit

2 rigid, 1 swivel and 1 swivel with brake casters
1,000 lb. capacity. Accepts 12 sizes of Ultra Bins (up to 192 bins). See chart for bin configurations.

QUANTITY OF ULTRA BINS TO FIT RAIL UNITS

MODEL NO.	DESCRIPTION	DIMENSIONS L" x W" x H"	QUANTITY OF ULTRA BINS TO FIT RAIL UNITS																							
			QUS 200	QUS 210	QUS 220	QUS 221	QUS 224	QUS 230	QUS 232	QUS 234	QUS 235	QUS 236	QUS 238	QUS 239	QUS 240	QUS 241	QUS 242	QUS 245	QUS 248	QUS 250	QUS 255	QUS 260	QUS 265	QUS 270		
QRU-1W	48"L Steel Rail	48" x 5/8" x 3"	11	11	11	8	11	8	4	8	4	4	8	5	5	5	3	5	-	-	-	-	-	-	-	
QRU-12S	Rack, 1 sided 12 rail	36" x 15" x 53"	96	96	96	-	-	-	36	-	-	36	-	24	24	24	20	-	24	12	12	12	20	8	-	
QRU-16S	Rack, 1 sided 16 rail	36" x 15" x 53"	-	-	-	48	48	48	-	48	24	-	48	-	-	-	16	-	-	-	-	-	-	-	-	
QRU-12D	Rack, 2 sided 12 rail	36" x 20" x 53"	192	192	192	-	-	-	72	-	-	72	-	48	48	48	40	-	48	24	24	24	40	16	-	
QRU-16D	Rack, 2 sided 16 rail	36" x 20" x 53"	-	-	-	96	96	96	-	96	48	-	96	-	-	-	32	-	-	-	-	-	-	-	-	
QRU-MOB	Mobile Kit - Mobilizes Double Sided Units																									

See pg. 5 for bin dimensions



Single & Double Sided Rail Systems - Complete Packages

Single Sided Systems: 36"L x 15"W x 53"H offers 600 lb. load capacity. Available in 4 different configurations.

Double Sided Systems: 36"L x 20"W x 53"H offers 1,600 lb. load capacity. Available in 3 different configurations. Mobilize double sided system with the addition of QRU-MOB.



QRU-16S-220230240

Bench Racks - Complete Packages

27-3/4"L x 8"W x 21"H and 36"L x 8"W x 19"H Bench Racks are available in 3 pre-configured choices. Bench Racks can be joined together to form continuous systems.



QBR-3619-210-32

Louvered Panels - Complete Packages

18"L x 19"H, 36"L x 19"H, 36"L x 61"H and 48"L x 61"H Louvered Panels are available in 3 configurations. Louvered Panels are available in Gray or Oyster White color. To order an Oyster White Louvered Panel add HC to the model number (i.e. QLP-1819HC-210-18). Mounting hardware is not included.



QLP-1819-220-16

Mobile Double Sided Louvered Rack Systems - Complete Packages

36"L x 25"W x 72"H Mobile Double Sided Louvered Rack System offers 1,200 lb. load capacity. 2 rigid, 2 swivel with brake hard rubber casters.



QMD-36H-230240



MODEL NO.	NO. OF BINS	BIN DIMENSIONS L" x W" x H"	SHIP WGT
36"L x 15"W x 53"H - Single Sided Rail Systems			
QRU-12S-220-96	96	7-3/8" x 4-1/8" x 3"	82 lbs
QRU-16S-230-48	48	10-7/8" x 5-1/2" x 5"	108 lbs
QRU-12S-240-24	24	14-3/4" x 8-1/4" x 7"	102 lbs
QRU-16S-220230240	16	7-3/8" x 4-1/8" x 3"	
	18	10-7/8" x 5-1/2" x 5"	108 lbs
	12	14-3/4" x 8-1/4" x 7"	
36"L x 20"W x 53"H - Double Sided Rail Systems			
QRU-12D-220-192	192	7-3/8" x 4-1/8" x 3"	113 lbs
QRU-16D-230-96	96	10-7/8" x 5-1/2" x 5"	155 lbs
QRU-12D-240-48	48	14-3/4" x 8-1/4" x 7"	153 lbs
QRU-MOB	Mobile Kit - Mobilizes Double Sided Systems		25 lbs

MODEL NO.	NO. OF BINS	BIN DIMENSIONS L" x W" x H"	SHIP WGT
27-3/4"L x 8"W x 21"H - Bench Racks			
QBR-2721-210-24	24	5-3/8" x 4-1/8" x 3"	23 lbs
QBR-2721-220-24	24	7-3/8" x 4-1/8" x 3"	25 lbs
QBR-2721-230-12	12	10-7/8" x 5-1/2" x 5"	28 lbs
36"L x 8"W x 19"H - Bench Racks			
QBR-3619-210-32	32	5-3/8" x 4-1/8" x 3"	29 lbs
QBR-3619-220-32	32	7-3/8" x 4-1/8" x 3"	31 lbs
QBR-3619-230-18	18	10-7/8" x 5-1/2" x 5"	37 lbs

MODEL NO.	NO. OF BINS	BIN DIMENSIONS L" x W" x H"	SHIP WGT
18"L x 19"H - Louvered Panels			
QLP-1819-210-16	16	5-3/8" x 4-1/8" x 3"	11 lbs
QLP-1819-220-16	16	7-3/8" x 4-1/8" x 3"	12 lbs
QLP-1819-230-9	9	10-7/8" x 5-1/2" x 5"	16 lbs
36"L x 19"H - Louvered Panels			
QLP-3619-210-32	32	5-3/8" x 4-1/8" x 3"	22 lbs
QLP-3619-220-32	32	7-3/8" x 4-1/8" x 3"	24 lbs
QLP-3619-230-18	18	10-7/8" x 5-1/2" x 5"	30 lbs
36"L x 61"H - Louvered Panels			
QLP-3661-220-120	120	7-3/8" x 4-1/8" x 3"	80 lbs
QLP-3661-230-60	60	10-7/8" x 5-1/2" x 5"	90 lbs
QLP-3661-240-28	28	14-3/4" x 8-1/4" x 7"	96 lbs
48"L x 61"H - Louvered Panels			
QLP-4861-220-165	165	7-3/8" x 4-1/8" x 3"	115 lbs
QLP-4861-230-80	80	10-7/8" x 5-1/2" x 5"	127 lbs
QLP-4861-240-35	35	14-3/4" x 8-1/4" x 7"	130 lbs

MODEL NO.	NO. OF BINS	BIN DIMENSIONS L" x W" x H"	SHIP WGT
36"L x 25"W x 72"H - Mobile Double Sided Louvered Rack			
QMD-36H-220	240	7-3/8" x 4-1/8" x 3"	174 lbs
QMD-36H-230	120	10-7/8" x 5-1/2" x 5"	212 lbs
QMD-36H-240	56	14-3/4" x 8-1/4" x 7"	208 lbs
QMD-36H-230240	72	10-7/8" x 5-1/2" x 5"	217 lbs
	24	14-3/4" x 8-1/4" x 7"	

COMPLETE PACKAGES WITH BINS

Bins available in: Blue Green Ivory Red Yellow Black Clear (One color per unit)



Giant Open Hopper Steel Shelving Systems - Complete Packages

These economical high density bin storage systems include heavy-duty giant stack bins with open hopper fronts for easy access. Optional clear window fronts maximize capacity, prevent spillage and convert the bin to a true tote. Optional dividers keep contents organized - available on **pg. 5**. Heavy-duty, industrial grade shelving with 400 lb. load capacity per shelf.



COMPLETE PACKAGES WITH BINS

12" Deep Systems

18" Deep Systems



QSBU-230240
12"D x 36"W x 75"H
10 shelves and 36 QUS230
10-7/8"L x 5-1/2"W x 5"H bins
and 12 QUS240
14-3/4"L x 8-1/4"W x 7"H bins



QSBU-239
12"D x 36"W x 75"H
8 shelves and 28 QUS239
10-3/4"L x 8-1/4"W x 7"H bins



QSBU-255
18"D x 36"W x 75"H
8 shelves and 21 QUS255
16"L x 11"W x 8"H bins
(Windows sold separately)



QSBU-260
18"D x 36"W x 75"H
6 shelves and 15 QUS260
18"L x 11"W x 10"H bins
(Windows and dividers sold separately)



QSBU-240
12"D x 36"W x 75"H
8 shelves and 28 QU240
14-3/4"L x 8-1/4"W x 7"H bins



QSBU-250
12"D x 36"W x 75"H
8 shelves and 14 QUS250
14-3/4"L x 16-1/2"W x 7"H bins



QSBU-265
18"D x 36"W x 75"H
7 shelves and 24 QUS265
18"L x 8-1/4"W x 9"H bins



QSBU-270
18"D x 36"W x 75"H
6 shelves and 10 QUS270
18"L x 16-1/2"W x 11"H bins

Bins available in: ● Blue ● Green ● Ivory ● Red ● Yellow ● Black ● Clear *(One color per unit)*



Giant Open Hopper Wire Shelving Systems - Complete Packages

CLEAR VIEW
AVAILABLE on pg. 20



MOBILIZE YOUR WIRE SHELVING

DB - Donut Bumper
Non-marking donut bumper used to protect walls and help cushion impact.

WR-00H (Mobile Kit)*
Set of four swivel thermoplastic resin 5" x 1-1/4" casters, two with brakes. 1,200 lb. load capacity. *Mobile Kits recommended only for shelves 18" and deeper.

COMPLETE PACKAGES WITH BINS

12" and 14" Deep Systems

18" Deep Systems



WR8-239
12"W x 36"L x 74"H
8 shelves and 28 QUS239
10-3/4"L x 8-1/4"W x 7"H bins



WR8-240
14"W x 36"L x 74"H
8 shelves and 28 QU240
14-3/4"L x 8-1/4"W x 7"H bins



WR8-255
18"W x 36"L x 74"H
8 shelves and 21 QUS255
16"L x 11"W x 8"H bins



WR6-260
18"W x 36"L x 74"H
6 shelves and 15 QUS260
18"L x 11"W x 10"H bins



WR8-250
14"W x 36"L x 74"H
8 shelves and 14 QUS250
14-3/4"L x 16-1/2"W x 7"H bins



WR10-230240
14"W x 36"L x 74"H
10 shelves and 36 QUS230
10-7/8"L x 5-1/2"W x 5"H bins and
12 QUS240 14-3/4"L x 8-1/4"W x 7"H bins



WR6-265
18"W x 36"L x 74"H
6 shelves and 20 QUS265
18"L x 8-1/4"W x 9"H bins



WR5-270
18"W x 36"L x 74"H
5 shelves and 8 QUS270
18"L x 16-1/2"W x 11"H bins

Bins available in: Blue Green Ivory Red Yellow Black Clear (One color per unit)



36" Wide All-Welded Bin Cabinet



All-Purpose cabinets provide secure storage for your valuable parts and tools. Standard performance features: ships completely assembled, ready to use, 14 gauge all-welded construction, gray or beige powder-coated finish which ensures years of heavy-duty service, 3 point locking handle supplied with 2 keys. To order a Beige cabinet, add **BG** right after cabinet prefix (i.e. **QSC-BG-36** or **MESH-BG-240** or **QPR-BG-101**). See pg. 5 for bin dimensions.



QSC-36-68 **NEW**

36"W x 24"D x 72"H. Deep Door model. Ship wt. 425 lbs. Total of **68** bins. **16 QUS232, 16 QUS236, 18 QUS230, 12 QUS240** and **6 QUS250**.

COMPLETE PACKAGES WITH BINS

Also Available:

QSC-36
Total of **132** bins.
48 QUS210
48 QUS220
18 QUS230
12 QUS240
6 QUS250

NEW

Also Available:

QSC-36S-38
Total of **38** bins.
16 QUS232
16 QUS236
6 QUS250



QSC-36S

36"W x 24"D x 72"H. Deep Door model. Ship wt. 465 lbs. Total of **102** bins. **48 QUS210, 48 QUS220, 6 QUS250** and **3** adjustable shelves. **800 lb.** capacity per interior shelf.

CABINETS NOW AVAILABLE WITH 2 BIN COMBINATIONS TO CHOOSE FROM

(New wider bins on doors NOW AVAILABLE)



QSC-64-2S-6DS

36"W x 24"D x 72"H. Deep Door model. Ship wt. 427 lbs. Total of **64** bins. **48 QUS220, 16 QUS240, 2** adjustable interior shelves and **6** door shelves. **800 lb.** capacity per interior shelf. **60 lb.** capacity per door shelf.

NEW

Also Available:

QSC-32-2S-6DS
Total of **32** bins.
16 QUS236
16 QUS240

NEW

Also Available:

QSC-36-32-4IS
Total of **32** bins.
32 QUS232



QSC-36-96-4IS

36"W x 24"D x 72"H. Deep Door model. Ship wt. 377 lbs. Total of **96** bins. **96 QUS210** and **4** adjustable interior shelves. **800 lb.** capacity per interior shelf.

CABINETS AVAILABLE IN GRAY OR BEIGE COLOR
14 GAUGE ALL-WELDED STEEL CONSTRUCTION

CABINET ARRIVES FULLY ASSEMBLED READY TO USE



QSC-36-FD

36"W x 18"D x 72"H. Flush Door model. Ship wt. 359 lbs. Total of **36** bins. **18 QUS230, 12 QUS240** and **6 QUS250**.



QSC-36-4IS-12DS

36"W x 24"D x 72"H. Deep Door model. Ship wt. 308 lbs. **4** adjustable interior shelves and **12** door shelves. **800 lb.** capacity per interior shelf. **60 lb.** capacity per door shelf.

Bins available in: ● Blue ● Green ● Ivory ● Red ● Yellow ● Black ● Clear (One color per unit)



QPR-101

Sloped Shelf Pick Rack Flow Cabinet
 36"W x 18"D x 78"H.
 Flush Door model. Ship wt. 298 lbs.
 Total of **72** bins. **Eight** sloped shelves
 and **one** flat shelf total **72 QSB101** bins.
 Additional cabinet configurations listed below.
 400 lb. capacity per interior shelf.



MODEL NO.	NO. OF BINS	BIN MODEL NO.	SHIP WGT
QPR-101	72	QSB101	298 lbs
QPR-102	45	QSB102	294 lbs
QPR-107	36	QSB107	289 lbs

See pg. 48 for bin dimensions

**CABINETS
 AVAILABLE IN
 GRAY OR BEIGE
 COLOR**



QSC-36-MIN

Counter High Cabinet
 36"W x 24"D x 36"H.

Ship wt. 218 lbs. Total of **66** bins. **24 QUS210**, **24 QUS220**, **12 QUS230**, **4 QUS240**
 and **2 QUS250**. See pg. 5 for bin dimensions.



QSC-QIC161

Interlocking Drawer Storage Cabinet
 48"W x 24"D x 78"H.

Ship wt. 507 lbs. Total of **128** bins and **15** Interlocking Drawer Cabinets. Louvered door fits
128 QUS210 bins (see pg. 5 for bin dimensions). Shelves hold **15** Interlocking Cabinet Units.
 Interlocking Cabinets have a Gray exterior, Drawers are available in Blue, Red, Ivory and Gray.
 Door bins available in Blue, Green, Ivory, Red, Yellow, Black and Clear.
 400 lb. capacity per interior shelf.

MODEL NO.	CABINET MODEL NO.	NO. OF DRAWERS	SHIP WGT
QSC-QIC161	QIC-161	240	507 lbs
QSC-QIC122	QIC-122	180	507 lbs
QSC-QIC83	QIC-83	120	492 lbs
QSC-QIC64	QIC-64	90	492 lbs

See pg. 94 for cabinet and drawer dimensions

Bins available in: ● Blue ● Green ● Ivory ● Red ● Yellow ● Black ● Clear (One color per unit)

MESH-240

Wire Mesh Safe-View Bin Cabinet
 36"W x 18"D x 78"H.
 Mesh Door model. Ship wt. 290 lbs.
 Total of **36** bins. Louvered back wall fits
36 QUS240. Additional cabinet
 configurations listed below.

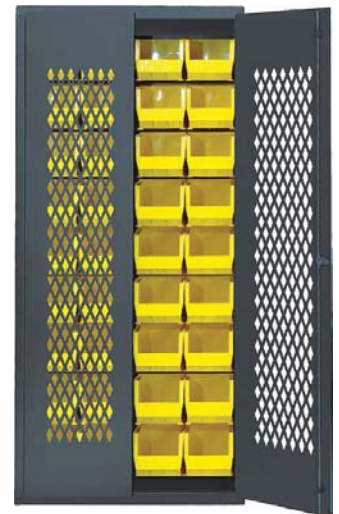

MODEL NO.	NO. OF BINS	BIN MODEL NO.	SHIP WGT
MESH-240	36	QUS240	290 lbs
MESH-240250	20 8	QUS240 QUS250	303 lbs
MESH-250	18	QUS250	288 lbs

See pg. 5 for bin dimensions

**COMPLETE
 PACKAGES
 WITH BINS**

QSC-C240250

Clear-View Security Bin Cabinet
 36"W x 18"D x 78"H.
 Clear Acrylic Door model. Ship wt. 388 lbs.
 Total of **28** bins. Louvered back wall fits
20 QUS240 and **8 QUS250**. Additional cabinet
 configurations listed below.



MODEL NO.	NO. OF BINS	BIN MODEL NO.	SHIP WGT
QSC-C240	36	QUS240	390 lbs
QSC-C240250	20 8	QUS240 QUS250	388 lbs
QSC-C250	18	QUS250	392 lbs

See pg. 5 for bin dimensions



QSC-3672-4D

Flush Door model. Ship wt. 663 lbs. Comes complete with **one** 18" deep adjustable shelf,
12 door shelves, **four** 31"W x 16"D drawers: **two** are 3" high, **one** is 5" high, **one** is 6" high.
 Total of **58** bins. **36 QUS220**, **18 QUS230** and **4 QUS240**.
 800 lb. capacity per interior shelf. 60 lb. capacity per door shelf.
 See pg. 5 for bin dimensions.



48" Wide All-Welded Bin Cabinets



These 48" wide models offer all of the features of the 36", but with additional storage space. All cabinets are also available in Beige color. To order a Beige cabinet, add **BG** right after cabinet prefix (i.e. **QSC-BG-48** or **MESH-BG-240** or **QPR-BG-101**). See pg. 5 for bin dimensions.



QSC-48

48"W x 24"D x 78"H. Flush Door Model. Ship wt. 522 lbs. Total of **171** bins. **64 QUS210, 64 QUS220, 24 QUS230, 13 QUS240** and **6 QUS250**.

COMPLETE PACKAGES WITH BINS



QSC-48S

48"W x 24"D x 78"H. Flush Door Model. Ship wt. 534 lbs. Total of **137** bins. **64 QUS210, 64 QUS220, 3 QUS240, 6 QUS250** and **3** adjustable shelves. **400 lb.** capacity per interior shelf.



QSC-4803

48"W x 24"D x 78"H. Flush Door Model. Ship wt. 505 lbs. Total of **128** bins. **128 QUS210** and **4** adjustable interior shelves. **400 lb.** capacity per interior shelf.

CABINETS AVAILABLE IN GRAY OR BEIGE COLOR



QSC-4804

48"W x 24"D x 78"H. Flush Door Model. Ship wt. 515 lbs. Total of **84** bins. **20 QUS240, 64 QUS220, 2** adjustable interior shelves and **6** door shelves. **400 lb.** capacity per interior shelf. **60 lb.** capacity per door shelf.



QSC-4805

48"W x 24"D x 78"H. Flush Door Cabinet. Ship wt. 484 lbs. Total of **64** bins. **64 QUS210** and punched panels on inside rear wall and doors, **2** adjustable interior shelves. **400 lb.** capacity per interior shelf.

PERFECT FOR JANITORIAL AND MAINTENANCE STORAGE



QSC-4IS-14DS

48"W x 24"D x 84"H. Deep Door Model. Ship wt. 572 lbs. **4** adjustable interior shelves and **14** adjustable door shelves. **400 lb.** capacity per interior shelf. **60 lb.** capacity per door shelf.

Bins available in: ● Blue ● Green ● Ivory ● Red ● Yellow ● Black ● Clear (One color per unit)



48" Wide All-Welded Cabinet



48" wide all-welded all purpose cabinet with 4 interior and adjustable shelves. Cabinet is also available in Beige color. To order Beige cabinet, add **BG** right after cabinet prefix (i.e. **QSC-BG-3IS**).

CABINET AVAILABLE IN GRAY OR BEIGE COLOR

14 GAUGE ALL-WELDED STEEL CONSTRUCTION

CABINET ARRIVES FULLY ASSEMBLED READY TO USE



QSC-3IS

48"W x 24"D x 78"H. Flush Door model. Ship wt. 323 lbs. 3 adjustable shelves. 400 lb. capacity per shelf.

Mobile Rail Cart



Mobilize your parts and supplies with this ultra-convenient storage and transport cart. Eliminates lugging heavy bins or loading them onto a regular cart. Multiple bin configurations to choose from. Flat top with raised edges contains more equipment and doubles as a work surface. 16-gauge cold-rolled steel with a powder coated gray finish. All-welded steel push handle. Two rigid and two swivel poly casters with brake. 800 lb. load capacity.

800 lb. MOBILE LOAD CAPACITY



QRC-4D Mobile Ergonomic Cart

36"L x 24"W x 35-1/2"H
800 lb. load capacity.

Accepts 6 sizes of Ultra Bins (up to 64 bins).
Includes 2 rigid and 2 swivel, with brake, hard rubber casters.
(Bins sold separately)

MODEL NO.	DESCRIPTION	QUS 200	QUS 210	QUS 220	QUS 230	QUS 235	QUS 239
Quantity of Ultra Bins to Fit Rail Cart							
QRC-4D	36" x 24" Rail Cart	64	64	64	48	24	16

See pg. 5 for bin dimensions

Bins available in: Blue Green Ivory Red Yellow Black Clear (One color per unit)



Super-Wide Colossal Heavy-Duty Cabinets



Super-Wide Colossal Cabinets offer 60" or 72" widths and 84" heights allowing for maximum and efficient storage while providing superior strength and security. Standard performance features: ships completely assembled, ready to use, 14 gauge all-welded construction, gray or beige powder-coated finish which ensures years of heavy-duty service, 3 point locking handle with provision for a padlock (*not included*) and 6" high legs make cabinets fork truck liftable. To order a Beige cabinet, add **BG** right after cabinet prefix (*i.e. QSC-BG-60 or MESH-BG-240 or QPR-BG-101*). See *pg. 5* for bin dimensions.



QSC-60
60"W x 24"D x 84"H. Flush Door model. Ship wt. 860 lbs.
Total of 227 bins. 80 QUS210, 90 QUS220, 30 QUS230, 18 QUS240 and 9 QUS250.



QSC-60S
60"W x 24"D x 84"H. Flush Door model. Ship wt. 878 lbs.
Total of 185 bins. 80 QUS210, 90 QUS220, 6 QUS240, 9 QUS250 and 3 adjustable shelves. 500 lb. capacity per interior shelf.

CABINETS AVAILABLE IN GRAY OR BEIGE COLOR

COMPLETE PACKAGES WITH BINS

72" CABINETS NOW AVAILABLE WITH 2 BIN COMBINATIONS TO CHOOSE FROM
(New wider bins on doors NOW AVAILABLE)



QSC-72
72"W x 24"D x 84"H. Flush Door model. Ship wt. 1,002 lbs.
Total of 264 bins. 96 QUS210, 96 QUS220, 36 QUS230, 24 QUS240 and 12 QUS250.

Also Available:
QSC-72-136 **NEW**
Total of 136 bins.
32 QUS232
32 QUS236
36 QUS230
24 QUS240
12 QUS250



Also Available:
QSC-72S
Total of 212 bins.
96 QUS210
96 QUS220
8 QUS240
12 QUS250

QSC-72S-84 **NEW**
72"W x 24"D x 84"H. Flush Door model. Ship wt. 955 lbs.
Total of 84 bins. 32 QUS232, 32 QUS236, 8 QUS240, 12 QUS250 and 3 adjustable shelves. 500 lb. capacity per interior shelf.

Bins available in: ● Blue ● Green ● Ivory ● Red ● Yellow ● Black ● Clear *(One color per unit)*



Clear-View Ultra Stack & Hang Bins



Organize your inventory with strong injection molded tri-clear virgin-grade polypropylene bins. Front, back and side grips for easy handling. Built in rear hanger allows bins to hang from louvered panels or rails. Optional clear injection molded crystal styrene window fronts increases bin capacity and provides quick view of bin contents. Dividers maximize flexibility and keep contents organized. Wide stacking ledge and anti-slide lock keep stacked bins steady and prevent forward shifting. Waterproof bins resist rust and corrosion. Large molded front label slots for ID labels. Autoclavable up to 250°F and resistant to extreme cold.



CLEAR VIEW BINS

NEW SIZES

QUANTUM IS CLEARLY YOUR STORAGE SOLUTION

See pg. 5 for accompanying dividers, clear lids, clear window fronts and clear label holders.



MOBILIZE YOUR WIRE SHELVING

DB - Donut Bumper
Non-marking donut bumper used to protect walls and help cushion impact.

WR-00H (Mobile Kit)*
Set of four swivel thermoplastic resin 5" x 1-1/4" casters, two with brakes. 1,200 lb. load capacity. *Mobile kits recommended only for shelves 18" and deeper.

COMPLETE PACKAGES WITH BINS

Clear-View Ultra Stack & Hang Bin Wire Shelving Systems - Complete Packages

Bins available in: Clear **800 lb. LOAD CAPACITY PER SHELF**

MODEL NO.	NO. OF SHELVES	NO. OF BINS	BIN DIMENSIONS L" x W" x H"	SHIP WGT
12"W x 36"L x 74"H - Systems				
WR8-239CL	8	28 QUS239CL	10-3/4" x 8-1/4" x 7"	103 lbs
WR7-245CL	7	24 QUS245CL	10-7/8" x 16-1/2" x 5"	111 lbs
14"W x 36"L x 74"H - Systems				
WR10-230240CL	10	36 QUS230CL 12 QUS240CL	10-7/8" x 5-1/2" x 5" 14-3/4" x 8-1/4" x 7"	146 lbs
WR8-240CL	8	28 QUS240CL	14-3/4" x 8-1/4" x 7"	128 lbs
WR8-250CL	8	14 QUS250CL	14-3/4" x 16-1/2" x 7"	129 lbs
18"W x 36"L x 74"H - Systems				
WR8-255CL	8	21 QUS255CL	16" x 11" x 8"	152 lbs
WR6-260CL	6	15 QUS260CL	18" x 11" x 10"	127 lbs
WR6-265CL	6	20 QUS265CL	18" x 8-1/4" x 9"	124 lbs
WR5-270CL	5	8 QUS270CL	18" x 16-1/2" x 11"	104 lbs

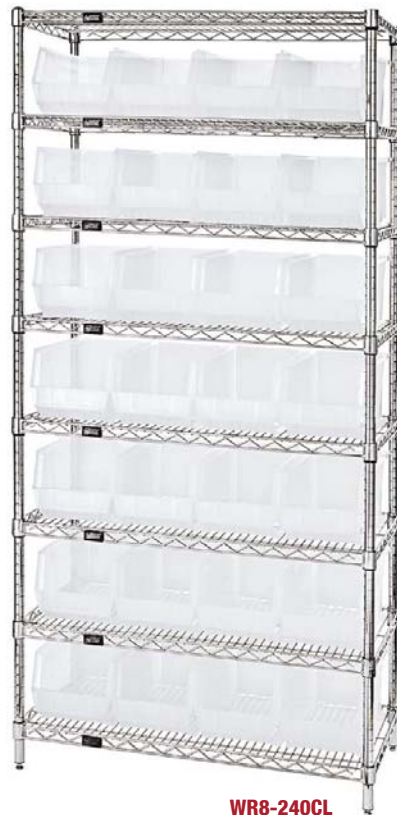

WR8-240CL



QSBU-240CL

Clear-View Ultra Stack & Hang Bin Steel Shelving Systems - Complete Packages

Bins available in: Clear **400 lb. LOAD CAPACITY PER SHELF**

MODEL NO.	NO. OF SHELVES	NO. OF BINS	BIN DIMENSIONS L" x W" x H"	SHIP WGT
12"D x 36"W x 75"H - Systems				
QSBU-239CL	8	28 QUS239CL	10-3/4" x 8-1/4" x 7"	99 lbs
QSBU-230240CL	10	36 QUS230CL 12 QUS240CL	10-7/8" x 5-1/2" x 5" 14-3/4" x 8-1/4" x 7"	122 lbs
QSBU-240CL	8	28 QUS240CL	14-3/4" x 8-1/4" x 7"	110 lbs
QSBU-245CL	7	24 QUS245CL	10-7/8" x 16-1/2" x 5"	111 lbs
QSBU-250CL	8	14 QUS250CL	14-3/4" x 16-1/2" x 7"	99 lbs
18"D x 36"W x 75"H - Systems				
QSBU-255CL	8	21 QUS255CL	16" x 11" x 8"	140 lbs
QSBU-260CL	6	15 QUS260CL	18" x 11" x 10"	120 lbs
QSBU-265CL	7	24 QUS265CL	18" x 8-1/4" x 9"	134 lbs
QSBU-270CL	6	10 QUS270CL	18" x 16-1/2" x 11"	117 lbs



QLP-1819-230-9CL



QBR-2721-220-24CL



Clear-View 12" Plastic Rail Systems - Complete Packages

Comes with 2 handy 12" Plastic Rails ideal for mounting to any surface. Bins can hang or stack securely providing an efficient bin storage system. Available in Clear. Rails available in White. Mounting hardware is not included.

MODEL NO.	BIN DIMENSIONS L" x W" x H"	DESCRIPTION	SHIP WGT
HNS200CL	5" x 4-1/8" x 3"	6 bins + 2 rails	2 lbs
HNS210CL	5-3/8" x 4-1/8" x 3"	6 bins + 2 rails	2 lbs
HNS220CL	7-3/8" x 4-1/8" x 3"	6 bins + 2 rails	3 lbs
HNS230CL	10-7/8" x 5-1/2" x 5"	4 bins + 2 rails	5 lbs
HNS006	Extra Rails	2 rails	1 lb

HNS230CL



COMPLETE PACKAGES WITH BINS



QMD-36H-240CL



QRU-12D-220-192CL + QRU-MOB Double Sided Rack, 12 Rails with Mobile Kit 1,000 lb. capacity. 2 rigid, 1 swivel and 1 swivel with brake hard rubber casters. Accepts 12 sizes of Ultra Bins (up to 192 bins).

Clear-View Bench Racks & Louvered Panel Systems - Complete Packages

Bench Racks: 27-3/4"L x 8"W x 21"H and 36"L x 8"W x 19"H. Both Bench Racks are available in 3 pre-configured choices. Bench Racks can be joined together to form continuous systems.

Louvered Panels: 18"L x 19"H, 36"L x 19"H, 36"L x 61"H and 48"L x 61"H panels are available in 3 configurations. Louvered Panels are available in Gray or Oyster White color. To order an Oyster White Louvered Panel add HC to the model number (i.e. QLP-1819HC-210-18CL). Mounting hardware is not included.

Bins available in: Clear

MODEL NO.	NO. OF BINS	BIN DIMENSIONS L" x W" x H"	SHIP WGT
27-3/4"L x 8"W x 21"H - Bench Rack Systems			
QBR-2721-210-24CL	24 QUS210CL	5-3/8" x 4-1/8" x 3"	23 lbs
QBR-2721-220-24CL	24 QUS220CL	7-3/8" x 4-1/8" x 3"	25 lbs
QBR-2721-230-12CL	12 QUS230CL	10-7/8" x 5-1/2" x 5"	28 lbs
36"L x 8"W x 19"H - Bench Rack Systems			
QBR-3619-210-32CL	32 QUS210CL	5-3/8" x 4-1/8" x 3"	29 lbs
QBR-3619-220-32CL	32 QUS220CL	7-3/8" x 4-1/8" x 3"	31 lbs
QBR-3619-230-18CL	18 QUS230CL	10-7/8" x 5-1/2" x 5"	37 lbs
18"L x 19"H - Louvered Panel Systems			
QLP-1819-210-16CL	16 QUS210CL	5-3/8" x 4-1/8" x 3"	11 lbs
QLP-1819-220-16CL	16 QUS220CL	7-3/8" x 4-1/8" x 3"	12 lbs
QLP-1819-230-9CL	9 QUS230CL	10-7/8" x 5-1/2" x 5"	16 lbs
36"L x 19"H - Louvered Panel Systems			
QLP-3619-210-32CL	32 QUS210CL	5-3/8" x 4-1/8" x 3"	22 lbs
QLP-3619-220-32CL	32 QUS220CL	7-3/8" x 4-1/8" x 3"	24 lbs
QLP-3619-230-18CL	18 QUS230CL	10-7/8" x 5-1/2" x 5"	30 lbs
36"L x 61"H - Louvered Panel Systems			
QLP-3661-220-120CL	120 QUS220CL	7-3/8" x 4-1/8" x 3"	80 lbs
QLP-3661-230-60CL	60 QUS230CL	10-7/8" x 5-1/2" x 5"	90 lbs
QLP-3661-240-28CL	28 QUS240CL	14-3/4" x 8-1/4" x 7"	96 lbs
48"L x 61"H - Louvered Panel Systems			
QLP-4861-220-165CL	165 QUS220CL	7-3/8" x 4-1/8" x 3"	115 lbs
QLP-4861-230-80CL	80 QUS230CL	10-7/8" x 5-1/2" x 5"	127 lbs
QLP-4861-240-35CL	35 QUS240CL	14-3/4" x 8-1/4" x 7"	130 lbs

Clear-View Rail Systems - Complete Packages

Bins available in: Clear

MODEL NO.	NO. OF BINS	BIN DIMENSIONS L" x W" x H"	SHIP WGT
36"L x 15"W x 53"H - Single Sided Rail Systems			
QRU-12S-220-96CL	96 QUS220CL	7-3/8" x 4-1/8" x 3"	82 lbs
QRU-16S-230-48CL	48 QUS230CL	10-7/8" x 5-1/2" x 5"	108 lbs
QRU-12S-240-24CL	24 QUS240CL	14-3/4" x 8-1/4" x 7"	102 lbs
QRU-16S-220230240CL	16 QUS220CL	7-3/8" x 4-1/8" x 3"	108 lbs
	18 QUS230CL	10-7/8" x 5-1/2" x 5"	
12 QUS240CL	14-3/4" x 8-1/4" x 7"		
36"L x 20"W x 53"H - Double Sided Rail Systems			
QRU-12D-220-192CL	192 QUS220CL	7-3/8" x 4-1/8" x 3"	113 lbs
QRU-16D-230-96CL	96 QUS230CL	10-7/8" x 5-1/2" x 5"	155 lbs
QRU-12D-240-48CL	48 QUS240CL	14-3/4" x 8-1/4" x 7"	153 lbs
QRU-MOB	Mobile Kit - Mobilizes Double Sided Systems		25 lbs

Clear-View Mobile Double Sided Louvered Rack Systems - Complete Packages

Bins available in: Clear

MODEL NO.	NO. OF BINS	BIN DIMENSIONS L" x W" x H"	SHIP WGT
36"L x 25"W x 72"H - Mobile Unit 1,200 lb. Capacity			
QMD-36H-220CL	240 QUS220CL	7-3/8" x 4-1/8" x 3"	174 lbs
QMD-36H-230CL	120 QUS230CL	10-7/8" x 5-1/2" x 5"	212 lbs
QMD-36H-240CL	56 QUS240CL	14-3/4" x 8-1/4" x 7"	208 lbs
QMD-36H-230240CL	72 QUS230CL	10-7/8" x 5-1/2" x 5"	217 lbs
	24 QUS240CL	14-3/4" x 8-1/4" x 7"	



Clear-View HULK 24" Containers



Organize and store your large and bulky items with these strong injection molded tri-clear virgin-grade polypropylene, stackable containers. These extra large stacking containers offer a generous 2 feet in length to store your larger items. Heavy-duty front, back and side grips allow for easy handling. Clear window fronts and dividers available on **pg. 34**. Wide stacking ledge and anti-slide lock keep stacked bins steady and prevent forward shifting. Waterproof bins resist rust and corrosion. Bins are autoclavable up to 250°F and are resistant to extreme cold.

Available in: Clear

MODEL NO.	OUTSIDE DIMENSIONS L" x W" x H"	CTN QTY	CTN WGT
QUS950CL	23-7/8" x 8-1/4" x 7"	6	18 lbs
QUS951CL	23-7/8" x 8-1/4" x 9"	6	21 lbs
QUS952CL	23-7/8" x 11" x 7"	4	14 lbs
QUS953CL	23-7/8" x 11" x 10"	4	18 lbs
QUS954CL	23-7/8" x 16-1/2" x 11"	1	7 lbs
QUS964MOBCL	23-7/8" x 16-1/2" x 11"*	1	9 lbs
QUS955CL	23-7/8" x 18-1/4" x 12"	1	8 lbs
QUS965MOBCL	23-7/8" x 18-1/4" x 12"*	1	10 lbs
QUS957CL <small>NEW</small>	23-7/8" x 22-1/2" x 12"	1	8 lbs
QUS967MOBCL <small>NEW</small>	23-7/8" x 22-1/2" x 12"*	1	10 lbs

*With casters, overall height for mobile container will be increased by 3"

QUANTUM IS CLEARLY YOUR STORAGE SOLUTION



Clear-View HULK 24" Container Wire Shelving Systems - Complete Packages

Bins available in: Clear **800 lb. LOAD CAPACITY PER SHELF**

MODEL NO.	NO. OF SHELVES	NO. OF BINS	BIN DIMENSIONS L" x W" x H"	SHIP WGT
24"W x 36"L x 74"H - Systems				
WR8-950CL	8	28 QUS950CL	23-7/8" x 8-1/4" x 7"	205 lbs
WR8-950952CL	8	12 QUS950CL 12 QUS952CL	23-7/8" x 8-1/4" x 7" 23-7/8" x 11" x 7"	197 lbs
WR8-952CL	8	21 QUS952CL	23-7/8" x 11" x 7"	191 lbs
WR7-951CL	7	24 QUS951CL	23-7/8" x 8-1/4" x 9"	188 lbs
WR7-20-MIXCL	7	8 QUS950CL	23-7/8" x 8-1/4" x 7"	182 lbs
		4 QUS951CL	23-7/8" x 8-1/4" x 9"	
		3 QUS952CL	23-7/8" x 11" x 7"	
		3 QUS953CL	23-7/8" x 11" x 10"	
		2 QUS954CL	23-7/8" x 16-1/2" x 11"	
WR6-953CL	6	15 QUS953CL	23-7/8" x 11" x 10"	156 lbs
WR6-953954CL	6	9 QUS953CL	23-7/8" x 11" x 10"	159 lbs
		4 QUS954CL	23-7/8" x 16-1/2" x 11"	
WR6-954CL	6	10 QUS954CL	23-7/8" x 16-1/2" x 11"	164 lbs
24"W x 42"L x 74"H - System				
WR5-955CL	5	8 QUS955CL	23-7/8" x 18-1/4" x 12"	145 lbs
24"W x 48"L x 74"H - System				
WR6-957CL <small>NEW</small>	6	10 QUS957CL	23-7/8" x 22-1/2" x 12"	192 lbs



COMPLETE PACKAGES WITH BINS



Clear-View HULK 24" Container Steel Shelving Systems - Complete Packages

Bins available in: Clear **350 lb. LOAD CAPACITY PER SHELF**

MODEL NO.	NO. OF SHELVES	NO. OF BINS	BIN DIMENSIONS L" x W" x H"	SHIP WGT
24"D x 36"W x 75"H - Systems				
2475-950CL	8	28 QUS950CL	23-7/8" x 8-1/4" x 7"	213 lbs
2475-950952CL	8	12 QUS950CL	23-7/8" x 8-1/4" x 7"	195 lbs
		12 QUS952CL	23-7/8" x 11" x 7"	
2475-952CL	8	21 QUS952CL	23-7/8" x 11" x 7"	205 lbs
2475-951CL	7	24 QUS951CL	23-7/8" x 8-1/4" x 9"	199 lbs
2475-20MIXCL	7	8 QUS950CL	23-7/8" x 8-1/4" x 7"	189 lbs
		4 QUS951CL	23-7/8" x 8-1/4" x 9"	
		3 QUS952CL	23-7/8" x 11" x 7"	
		3 QUS953CL	23-7/8" x 11" x 10"	
		2 QUS954CL	23-7/8" x 16-1/2" x 11"	
2475-953CL	6	15 QUS953CL	23-7/8" x 11" x 10"	163 lbs
2475-953954CL	6	9 QUS953CL	23-7/8" x 11" x 10"	166 lbs
		4 QUS954CL	23-7/8" x 16-1/2" x 11"	
2475-954CL	6	10 QUS954CL	23-7/8" x 16-1/2" x 11"	171 lbs



MOBILIZE YOUR WIRE SHELVING

DB - Donut Bumper
Non-marking donut bumper used to protect walls and help cushion impact.

WR-00H (Mobile Kit)
Set of four swivel thermoplastic resin 5" x 1-1/4" casters, two with brakes. Can be used with all systems shown. 1,200 lb. load capacity.



Clear-View Giant Stack Containers



QGH700CL



QGH705MOBCL

Multipurpose, wide open hopper front provides easy access for large part storage. Ideal for multiple applications in recycling, storing parts, tools and warehouse items. This bin will stack up to 6 bins high creating a sturdy, tall storage system. Injection molded from high density tri-clear virgin-grade polypropylene, easy to clean, resists rust and corrosion and impervious to most chemicals. Large label holder allows for quick identification. Optional clear window front increases storage capacity and allows for inspection of parts. Six 1/4" drill hole pattern on bottom of bin allows for easy hole insertion for drainage.

Available in: Clear

MODEL NO.	OUTSIDE DIMENSIONS L" x W" x H"	CTN QTY	CTN WGT	WINDOW	CTN WGT
QGH600CL	17-1/2" x 10-7/8" x 12-1/2"	4	12 lbs	WGH600	4
QGH700CL*	15-1/4" x 19-7/8" x 12-7/16"	3	13 lbs	WGH700	3
QGH800CL*	17-1/2" x 16-1/2" x 12-1/2"	2	8 lbs	WGH800	2

*With casters, overall height for mobile container will be increased by 3"

COMPLETE PACKAGES WITH BINS



WR5-600CL



QUANTUM IS CLEARLY YOUR STORAGE SOLUTION



QSBU-700CL



MOBILIZE YOUR WIRE SHELVING

DB - Donut Bumper
Non-marking donut bumper used to protect walls and help cushion impact.

WR-00H (Mobile Kit)
Set of four swivel thermoplastic resin 5" x 1-1/4" casters, two with brakes. Can be used with all systems shown. 1,200 lb. load capacity.

Clear-View Mobile Giant Stack Containers



- Ideal for transport of heavy and bulky parts
- Container comes with 4 swivel, 3" polyurethane casters, all with brakes, allowing for up to 250 lb. mobile load capacity
- Containers can stack with casters in place

Available in: Clear

MODEL NO.	OUTSIDE DIMENSIONS L" x W" x H"	CTN QTY	CTN WGT	WINDOW	CTN WGT
QGH705MOBCL*	15-1/4" x 19-7/8" x 12-7/16"	3	22 lbs	WGH700	3
QGH805MOBCL*	17-1/2" x 16-1/2" x 12-1/2"	2	17 lbs	WGH800	2

*With casters, overall height for mobile container will be increased by 3"

Clear-View Giant Stack Wire Shelving Systems - Complete Packages

Bins available in: Clear **800 lb. LOAD CAPACITY PER SHELF**

MODEL NO.	NO. OF BINS	BIN DIMENSIONS L" x W" x H"	SHIP WGT
18"W x 36"L x 74"H - 5 Shelf Systems			
WR5-600CL	12 QGH600CL	17-1/2" x 10-7/8" x 12-1/2"	104 lbs
WR5-600800CL	6 QGH600CL	17-1/2" x 10-7/8" x 12-1/2"	103 lbs
	4 QGH800CL	17-1/2" x 16-1/2" x 12-1/2"	
WR5-800CL	8 QGH800CL	17-1/2" x 16-1/2" x 12-1/2"	102 lbs
18"W x 42"L x 74"H - 5 Shelf System			
WR5-700CL	8 QGH700CL	15-1/4" x 19-7/8" x 12-7/16"	98 lbs

Clear-View Giant Stack Steel Shelving Systems - Complete Packages

Smooth powder coat finish and cross bracing for increased stability. 400 lb. capacity per shelf and over 21 cubic feet of storage space.

Bins available in: Clear **400 lb. LOAD CAPACITY PER SHELF**

MODEL NO.	NO. OF BINS	BIN DIMENSIONS L" x W" x H"	SHIP WGT
18"W x 36"L x 75"H - 6 Shelf Systems			
QSBU-600CL	12 QGH600CL	17-1/2" x 10-7/8" x 12-1/2"	116 lbs
QSBU-600800CL	6 QGH600CL	17-1/2" x 10-7/8" x 12-1/2"	114 lbs
	6 QGH800CL	17-1/2" x 16-1/2" x 12-1/2"	
QSBU-800CL	10 QGH800CL	17-1/2" x 16-1/2" x 12-1/2"	113 lbs
18"W x 42"L x 75"H - 6 Shelf System			
QSBU-700CL	10 QGH700CL	15-1/4" x 19-7/8" x 12-7/16"	123 lbs



Clear-View Economy 4" Shelf Bins



Quantum's tough, durable, high density Economy 4" Shelf Bins are the industry standard for quality. These tri-clear virgin-grade polypropylene bins feature a molded-in label holder, built-in rear hanglock which allows bins to tilt out for complete access when on shelving. A wide hopper front allows complete access to the contents of the bin. Edges are reinforced for added strength. They are designed for 12", 18" and 24" deep shelf units, racks or standard shelving. Bins are impervious to most chemicals. Dividers, bin cups and label holders available on [pg. 48](#).



QSB106CL



MOBILIZE YOUR WIRE SHELVING

DB - Donut Bumper

Non-marking donut bumper used to protect walls and help cushion impact.

WR-00H (Mobile Kit)*

Set of four swivel thermoplastic resin 5" x 1-1/4" casters, two with brakes. 1,200 lb. load capacity. *Mobile kits recommended only for shelves 18" and deeper.

QUANTUM IS CLEARLY YOUR STORAGE SOLUTION

COMPLETE PACKAGES WITH BINS



WR12-107CL



WR6-36-1236-109CL

Available in: Clear

MODEL NO.	OUTSIDE DIMENSIONS L" x W" x H"	CTN QTY	CTN WGT
QSB100CL	11-5/8" x 2-3/4" x 4"	36	13 lbs
QSB101CL	11-5/8" x 4-1/8" x 4"	36	17 lbs
QSB102CL	11-5/8" x 6-5/8" x 4"	30	18 lbs
QSB107CL	11-5/8" x 8-3/8" x 4"	20	15 lbs
QSB109CL	11-5/8" x 11-1/8" x 4"	8	7 lbs
QSB103CL	17-7/8" x 4-1/8" x 4"	20	13 lbs
QSB104CL	17-7/8" x 6-5/8" x 4"	20	16 lbs
QSB108CL	17-7/8" x 8-3/8" x 4"	10	11 lbs
QSB110CL	17-7/8" x 11-1/8" x 4"	8	11 lbs
QSB105CL	23-5/8" x 4-1/8" x 4"	16	13 lbs
QSB106CL	23-5/8" x 6-5/8" x 4"	8	9 lbs
QSB114CL	23-5/8" x 8-3/8" x 4"	6	9 lbs
QSB116CL	23-5/8" x 11-1/8" x 4"	6	10 lbs



Clear-View Complete Bin Center

Complete bin systems are available with 4 different size bin options on a 12"W x 36"L x 36"H unit. This all-purpose bin center is an economical high density storage system that provides superior visibility to stored contents.

Bins available in: Clear **800 lb. LOAD CAPACITY PER SHELF**

MODEL NO.	NO. OF BINS	BIN DIMENSIONS L" x W" x H"	SHIP WGT
12"W x 36"L x 36"H - 6 Shelf Systems			
WR6-36-1236-101CL	40 QSB101CL	11-5/8" x 4-1/8" x 4"	63 lbs
WR6-36-1236-102CL	25 QSB102CL	11-5/8" x 6-5/8" x 4"	50 lbs
WR6-36-1236-107CL	20 QSB107CL	11-5/8" x 8-3/8" x 4"	62 lbs
WR6-36-1236-109CL	15 QSB109CL	11-5/8" x 11-1/8" x 4"	64 lbs

Clear-View Economy 4" Shelf Bin Wire Shelving Systems - Complete Packages

Bins available in: Clear **800 lb. LOAD CAPACITY PER SHELF**

MODEL NO.	NO. OF BINS	BIN DIMENSIONS L" x W" x H"	SHIP WGT
12"W x 36"L x 74"H - 12 Shelf Systems			
WR12-101CL	88 QSB101CL	11-5/8" x 4-1/8" x 4"	120 lbs
WR12-102CL	55 QSB102CL	11-5/8" x 6-5/8" x 4"	116 lbs
WR12-107CL	44 QSB107CL	11-5/8" x 8-3/8" x 4"	117 lbs
WR12-109CL	33 QSB109CL	11-5/8" x 11-1/8" x 4"	119 lbs
18"W x 36"L x 74"H - 12 Shelf Systems			
WR12-103CL	88 QSB103CL	17-7/8" x 4-1/8" x 4"	176 lbs
WR12-104CL	55 QSB104CL	17-7/8" x 6-5/8" x 4"	165 lbs
WR12-108CL	44 QSB108CL	17-7/8" x 8-3/8" x 4"	170 lbs
WR12-110CL	33 QSB110CL	17-7/8" x 11-1/8" x 4"	168 lbs
24"W x 36"L x 74"H - 12 Shelf Systems			
WR12-105CL	88 QSB105CL	23-5/8" x 4-1/8" x 4"	228 lbs
WR12-106CL	55 QSB106CL	23-5/8" x 6-5/8" x 4"	218 lbs
WR12-114CL	44 QSB114CL	23-5/8" x 8-3/8" x 4"	222 lbs
WR12-116CL	33 QSB116CL	23-5/8" x 11-1/8" x 4"	206 lbs



QPRHA-100CL
350 lb.
LOAD CAPACITY

SLOPED SHELVES EASY ACCESS

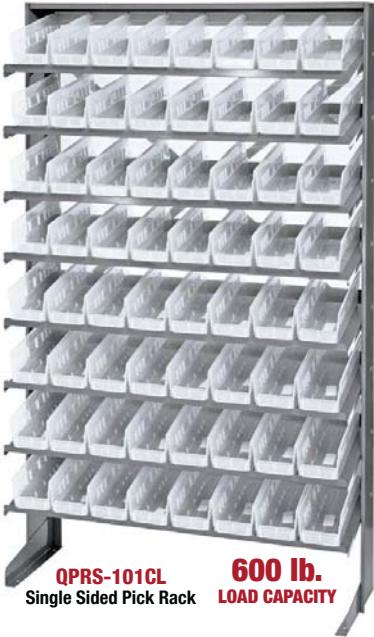

QPRS-101CL
Single Sided Pick Rack
600 lb.
LOAD CAPACITY



QPRD-109CL
Double Sided Pick Rack
1,600 lb.
LOAD CAPACITY

COMPLETE PACKAGES WITH BINS



1239-107CL

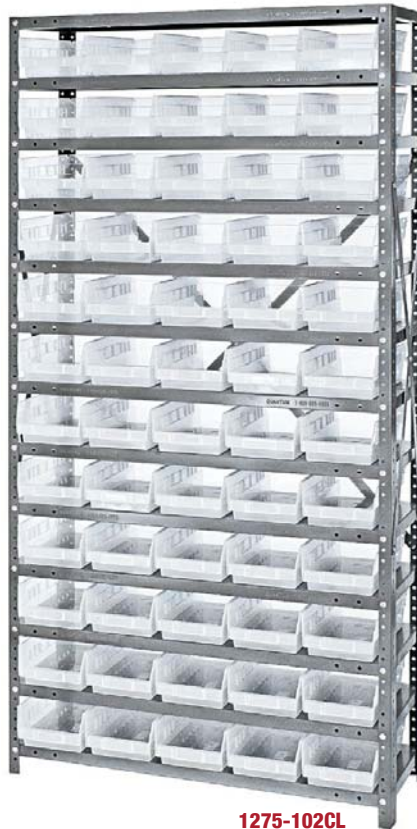

1275-102CL

Clear-View Economy 4" Shelf Bin Sloped Shelving Systems - Complete Packages

Pick Racks provide a convenient high density, easy access, sloped shelving system, available as bench units, single and double sided free standing and mobile units. Unit comes complete with Economical Shelf Bins. Sloped shelving unit keeps small and medium sized parts easily accessible. Open hopper front bins with label area, provide fast access to stored items. This all-in-one unit is easy to clean and will not rust or corrode. See chart for configurations. Additional 18" and 36" deep systems available on **pg. 50**. Bins available in Clear.

Bins available in: Clear

MODEL NO.	NO. OF BINS	BIN DIMENSIONS L" x W" x H"	SHIP WGT
12-1/2"L x 36"W x 23"H - 3 Shelf Bench Rack Systems			
QPRHA-100CL	36 QSB100CL	11-5/8" x 2-3/4" x 4"	41 lbs
QPRHA-101CL	24 QSB101CL	11-5/8" x 4-1/8" x 4"	38 lbs
QPRHA-102CL	15 QSB102CL	11-5/8" x 6-5/8" x 4"	36 lbs
QPRHA-107CL	12 QSB107CL	11-5/8" x 8-3/8" x 4"	36 lbs
QPRHA-109CL	9 QSB109CL	11-5/8" x 11-1/8" x 4"	37 lbs
12"L x 36"W x 60"H - Single Sided 8 Shelf Rack Systems			
QPRS-100CL	96 QSB100CL	11-5/8" x 2-3/4" x 4"	99 lbs
QPRS-101CL	64 QSB101CL	11-5/8" x 4-1/8" x 4"	85 lbs
QPRS-102CL	40 QSB102CL	11-5/8" x 6-5/8" x 4"	80 lbs
QPRS-107CL	32 QSB107CL	11-5/8" x 8-3/8" x 4"	81 lbs
QPRS-109CL	24 QSB109CL	11-5/8" x 11-1/8" x 4"	83 lbs
24"L x 36"W x 60"H - Double Sided 16 Shelf Rack Systems			
QPRD-100CL	192 QSB100CL	11-5/8" x 2-3/4" x 4"	195 lbs
QPRD-101CL	128 QSB101CL	11-5/8" x 4-1/8" x 4"	169 lbs
QPRD-102CL	80 QSB102CL	11-5/8" x 6-5/8" x 4"	158 lbs
QPRD-107CL	64 QSB107CL	11-5/8" x 8-3/8" x 4"	160 lbs
QPRD-109CL	48 QSB109CL	11-5/8" x 11-1/8" x 4"	163 lbs
QDU-00*	Mobile Kit - Mobilizes All Double Sided Systems		25 lbs

*1,200 lb. load capacity. 2 rigid, 2 swivel with brake hard rubber casters.

Clear-View Economy 4" Shelf Bin Steel Shelving Systems - Complete Packages

Bins available in: Clear **350 lb. LOAD CAPACITY PER SHELF**

MODEL NO.	NO. OF BINS	BIN DIMENSIONS L" x W" x H"	SHIP WGT
12"D x 36"W x 75"H - 13 Shelf Systems			
1275-100CL	144 QSB100CL	11-5/8" x 2-3/4" x 4"	139 lbs
1275-101CL	96 QSB101CL	11-5/8" x 4-1/8" x 4"	117 lbs
1275-102CL	60 QSB102CL	11-5/8" x 6-5/8" x 4"	115 lbs
1275-107CL	48 QSB107CL	11-5/8" x 8-3/8" x 4"	120 lbs
1275-109CL	36 QSB109CL	11-5/8" x 11-1/8" x 4"	119 lbs
12"D x 36"W x 39"H - 7 Shelf Systems			
1239-100CL	72 QSB100CL	11-5/8" x 2-3/4" x 4"	75 lbs
1239-101CL	48 QSB101CL	11-5/8" x 4-1/8" x 4"	67 lbs
1239-102CL	30 QSB102CL	11-5/8" x 6-5/8" x 4"	63 lbs
1239-107CL	24 QSB107CL	11-5/8" x 8-3/8" x 4"	64 lbs
1239-109CL	18 QSB109CL	11-5/8" x 11-1/8" x 4"	65 lbs
18"D x 36"W x 75"H - 13 Shelf Systems			
1875-103CL	96 QSB103CL	17-7/8" x 4-1/8" x 4"	161 lbs
1875-104CL	60 QSB104CL	17-7/8" x 6-5/8" x 4"	155 lbs
1875-108CL	48 QSB108CL	17-7/8" x 8-3/8" x 4"	161 lbs
1875-110CL	36 QSB110CL	17-7/8" x 11-1/8" x 4"	158 lbs
18"D x 36"W x 39"H - 7 Shelf Systems			
1839-103CL	48 QSB103CL	17-7/8" x 4-1/8" x 4"	87 lbs
1839-104CL	30 QSB104CL	17-7/8" x 6-5/8" x 4"	84 lbs
1839-108CL	24 QSB108CL	17-7/8" x 8-3/8" x 4"	87 lbs
1839-110CL	18 QSB110CL	17-7/8" x 11-1/8" x 4"	86 lbs



Clear-View STORE-MORE 6" Shelf Bins



Maximize your storage space with durable, high density tri-clear virgin-grade polypropylene bins. Quantum's STORE-MORE 6" Shelf Bins are the industry standard for quality. These bins feature a molded-in label holder, built-in rear hang-lock which allows bins to tilt out for complete access when on shelving. A wide hopper front allows complete access to the contents of the bin. Edges are reinforced for added strength. They are designed for 12", 18" and 24" deep shelf units, racks or standard shelving. Optional dividers are a perfect solution to create a par level system. Bins are waterproof and corrosion-free. Dividers, bin cups and label holders available on [pg. 53](#).



MOBILIZE YOUR WIRE SHELVING

DB - Donut Bumper
Non-marking donut bumper used to protect walls and help cushion impact.

WR-00H (Mobile Kit)*
Set of four swivel thermoplastic resin 5" x 1-1/4" casters, two with brakes. 1,200 lb. load capacity. *Mobile kits recommended only for shelves 18" and deeper.

QUANTUM IS CLEARLY YOUR STORAGE SOLUTION

COMPLETE PACKAGES WITH BINS



WR5-39-1236-209CL

WR9-202CL

Available in: Clear

MODEL NO.	OUTSIDE DIMENSIONS L" x W" x H"	CTN QTY	CTN WGT
QSB201CL	11-5/8" x 4-1/8" x 6"	36	19 lbs
QSB202CL	11-5/8" x 6-5/8" x 6"	30	20 lbs
QSB207CL	11-5/8" x 8-3/8" x 6"	20	17 lbs
QSB209CL	11-5/8" x 11-1/8" x 6"	8	9 lbs
QSB203CL	17-7/8" x 4-1/8" x 6"	20	15 lbs
QSB204CL	17-7/8" x 6-5/8" x 6"	20	18 lbs
QSB208CL	17-7/8" x 8-3/8" x 6"	10	13 lbs
QSB210CL	17-7/8" x 11-1/8" x 6"	8	13 lbs
QSB205CL	23-5/8" x 4-1/8" x 6"	16	15 lbs
QSB206CL	23-5/8" x 6-5/8" x 6"	8	11 lbs
QSB214CL	23-5/8" x 8-3/8" x 6"	6	11 lbs
QSB216CL	23-5/8" x 11-1/8" x 6"	6	12 lbs

68% more storage capacity over standard 4" shelf bins, Quantum's **STORE-MORE 6"** Shelf Bins were an industry first and now an industry leader.



Clear-View Complete Bin Center

Complete bin systems are available with 4 different size bins on a 12"W x 36"L x 39"H unit. This all-purpose bin center is an economical high density storage system that provides easy visibility to stored contents.

Bins available in: Clear **800 lb. LOAD CAPACITY PER SHELF**

MODEL NO.	NO. OF BINS	BIN DIMENSIONS L" x W" x H"	SHIP WGT
12"W x 36"L x 39"H - 5 Shelf Systems			
WR5-39-1236-201CL	32 QSB201CL	11-5/8" x 4-1/8" x 6"	61 lbs
WR5-39-1236-202CL	20 QSB202CL	11-5/8" x 6-5/8" x 6"	57 lbs
WR5-39-1236-207CL	16 QSB207CL	11-5/8" x 8-3/8" x 6"	56 lbs
WR5-39-1236-209CL	12 QSB209CL	11-5/8" x 11-1/8" x 6"	55 lbs

Clear-View STORE-MORE 6" Shelf Bin Wire Shelving Systems - Complete Packages

Bins available in: Clear **800 lb. LOAD CAPACITY PER SHELF**

MODEL NO.	NO. OF BINS	BIN DIMENSIONS L" x W" x H"	SHIP WGT
12"W x 36"L x 74"H - 9 Shelf Systems			
WR9-201CL	64 QSB201CL	11-5/8" x 4-1/8" x 6"	108 lbs
WR9-202CL	40 QSB202CL	11-5/8" x 6-5/8" x 6"	100 lbs
WR9-207CL	32 QSB207CL	11-5/8" x 8-3/8" x 6"	98 lbs
WR9-209CL	24 QSB209CL	11-5/8" x 11-1/8" x 6"	96 lbs
18"W x 36"L x 74"H - 9 Shelf Systems			
WR9-203CL	64 QSB203CL	17-7/8" x 4-1/8" x 6"	156 lbs
WR9-204CL	40 QSB204CL	17-7/8" x 6-5/8" x 6"	142 lbs
WR9-208CL	32 QSB208CL	17-7/8" x 8-3/8" x 6"	143 lbs
WR9-210CL	24 QSB210CL	17-7/8" x 11-1/8" x 6"	140 lbs
24"W x 36"L x 74"H - 9 Shelf Systems			
WR9-205CL	64 QSB205CL	23-5/8" x 4-1/8" x 6"	182 lbs
WR9-206CL	40 QSB206CL	23-5/8" x 6-5/8" x 6"	171 lbs
WR9-214CL	32 QSB214CL	23-5/8" x 8-3/8" x 6"	165 lbs
WR9-216CL	24 QSB216CL	23-5/8" x 11-1/8" x 6"	154 lbs

**QPRHA-201CL**
350 lb.
LOAD CAPACITY**QPRS-202CL**
Single Sided Pick Rack **600 lb.**
LOAD CAPACITY

SLOPED SHELVES EASY ACCESS

**QPRD-209CL**
Double Sided Pick Rack **1,600 lb.**
LOAD CAPACITY**1275-202CL****1239-201CL**

QUANTUM IS CLEARLY YOUR STORAGE SOLUTION

Clear-View STORE-MORE 6" Shelf Bin Sloped Steel Shelving Systems - Complete Packages

Pick Racks provide a convenient high density, easy access, sloped shelving system, available as bench units, single and double sided free standing and mobile units. Unit complete with STORE-MORE 6" Shelf Bins. Sloped shelving unit keeps small and medium sized parts easily accessible. Open hopper front bins with label area, provide fast access to stored items. This all-in-one unit is easy to clean and will not rust or corrode. See chart for configurations. Additional 18" and 36" deep systems available on **pg. 55**. Bins available in Clear.

Bins available in: Clear

MODEL NO.	NO. OF BINS	BIN DIMENSIONS L" x W" x H"	SHIP WGT
12"L x 36"W x 26-1/2"H - 3 Shelf Bench Rack Systems			
QPRHA-201CL	24 QSB201CL	11-5/8" x 4-1/8" x 6"	40 lbs
QPRHA-202CL	15 QSB202CL	11-5/8" x 6-5/8" x 6"	37 lbs
QPRHA-207CL	12 QSB207CL	11-5/8" x 8-3/8" x 6"	36 lbs
QPRHA-209CL	9 QSB209CL	11-5/8" x 11-1/8" x 6"	35 lbs
12"L x 36"W x 63-1/2"H - Single Sided 8 Shelf Rack Systems			
QPRS-201CL	64 QSB201CL	11-5/8" x 4-1/8" x 6"	89 lbs
QPRS-202CL	40 QSB202CL	11-5/8" x 6-5/8" x 6"	81 lbs
QPRS-207CL	32 QSB207CL	11-5/8" x 8-3/8" x 6"	79 lbs
QPRS-209CL	24 QSB209CL	11-5/8" x 11-1/8" x 6"	77 lbs
24"L x 36"W x 63-1/2"H - Double Sided 16 Shelf Rack Systems			
QPRD-201CL	128 QSB201CL	11-5/8" x 4-1/8" x 6"	178 lbs
QPRD-202CL	80 QSB202CL	11-5/8" x 6-5/8" x 6"	162 lbs
QPRD-207CL	64 QSB207CL	11-5/8" x 8-3/8" x 6"	158 lbs
QPRD-209CL	48 QSB209CL	11-5/8" x 11-1/8" x 6"	154 lbs
QDU-00*	Mobile Kit - Mobilizes All Double Sided Systems		25 lbs

*1,200 lb. load capacity. 2 rigid, 2 swivel with brake hard rubber casters.

COMPLETE PACKAGES WITH BINS

Clear-View STORE-MORE 6" Shelf Bin Steel Shelving Systems - Complete Packages

Bins available in: Clear **400 lb. LOAD CAPACITY PER SHELF**

MODEL NO.	NO. OF BINS	BIN DIMENSIONS L" x W" x H"	SHIP WGT
12"D x 36"W x 75"H - 10 Shelf Systems			
1275-201CL	72 QSB201CL	11-5/8" x 4-1/8" x 6"	111 lbs
1275-202CL	45 QSB202CL	11-5/8" x 6-5/8" x 6"	103 lbs
1275-207CL	36 QSB207CL	11-5/8" x 8-3/8" x 6"	100 lbs
1275-209CL	27 QSB209CL	11-5/8" x 11-1/8" x 6"	98 lbs
12"D x 36"W x 39"H - 5 Shelf Systems			
1239-201CL	32 QSB201CL	11-5/8" x 4-1/8" x 6"	56 lbs
1239-202CL	20 QSB202CL	11-5/8" x 6-5/8" x 6"	52 lbs
1239-207CL	16 QSB207CL	11-5/8" x 8-3/8" x 6"	51 lbs
1239-209CL	12 QSB209CL	11-5/8" x 11-1/8" x 6"	50 lbs
18"D x 36"W x 75"H - 10 Shelf Systems			
1875-203CL	72 QSB203CL	17-7/8" x 4-1/8" x 6"	156 lbs
1875-204CL	45 QSB204CL	17-7/8" x 6-5/8" x 6"	141 lbs
1875-208CL	36 QSB208CL	17-7/8" x 8-3/8" x 6"	142 lbs
1875-210CL	27 QSB210CL	17-7/8" x 11-1/8" x 6"	139 lbs
18"D x 36"W x 39"H - 5 Shelf Systems			
1839-203CL	32 QSB203CL	17-7/8" x 4-1/8" x 6"	77 lbs
1839-204CL	20 QSB204CL	17-7/8" x 6-5/8" x 6"	70 lbs
1839-208CL	16 QSB208CL	17-7/8" x 8-3/8" x 6"	71 lbs
1839-210CL	12 QSB210CL	17-7/8" x 11-1/8" x 6"	69 lbs

QUANTUM IS CLEARLY YOUR STORAGE SOLUTION

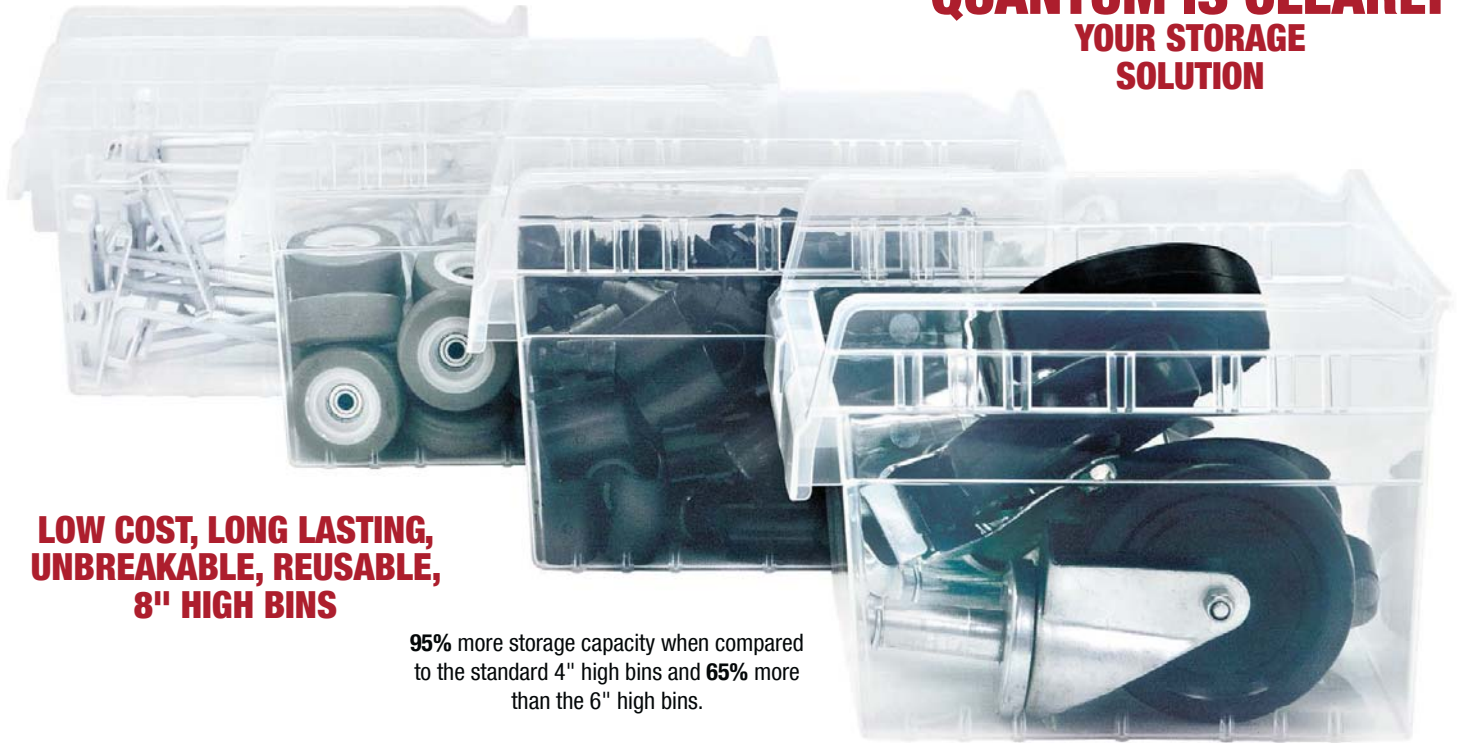

LOW COST, LONG LASTING, UNBREAKABLE, REUSABLE, 8" HIGH BINS

95% more storage capacity when compared to the standard 4" high bins and 65% more than the 6" high bins.



LTR-1253 Clear Label Holder
Clear label holders and laser label inserts. Clear label holders fit all 8" Shelf Bins. Package of 25.



Divider Label Tab

Divider Label Tabs attach to existing dividers to improve the visibility of bin labels and scanning of barcodes. Package of 6.

DLT-6

Clear-View STORE-MAX 8" Shelf Bins



Our new 8" high bins offer 95% more storage capacity when compared to the standard 4" high bins and 65% more than the 6" high bins. The new STORE-MAX 8" bins will truly maximize and organize your space. Manufactured from high density tri-clear virgin-grade polypropylene, STORE-MAX 8" Shelf Bins are the industry standard for quality. These bins feature a molded-in label holder on a wide hopper front allowing complete access to the contents of the bin. Edges are reinforced for added strength. They are designed for 12", 18" and 24" deep shelf units, racks or standard shelving. Optional dividers are a perfect accessory to subdivide and keep parts separated as needed.

Available in: Clear

MODEL NO.	OUTSIDE DIMENSIONS L" x W" x H"	INSIDE DIMENSIONS L" x W" x H"	CTN QTY	CTN WGT	DIVIDER	CTN QTY	NO. OF BIN CUPS PER BIN
							QBC111 QBC112
QSB801CL	11-5/8" x 4-3/8" x 8"	10-1/6" x 3" x 8"	36	19 lbs	DSB801	50	6 2
QSB802CL	11-5/8" x 6-5/8" x 8"	10-1/6" x 5-1/2" x 8"	30	20 lbs	DSB802	50	9 4
QSB807CL	11-5/8" x 8-3/8" x 8"	10-1/6" x 7-1/8" x 8"	20	17 lbs	DSB807	50	12 4
QSB809CL	11-5/8" x 11-1/8" x 8"	10-1/6" x 10" x 8"	8	9 lbs	DSB809	50	18 6
QSB803CL	17-7/8" x 4-3/8" x 8"	16-1/2" x 3" x 8"	20	15 lbs	DSB803	50	9 3
QSB804CL	17-7/8" x 6-5/8" x 8"	16-1/2" x 5-1/2" x 8"	20	18 lbs	DSB804	50	15 6
QSB808CL	17-7/8" x 8-3/8" x 8"	16-1/2" x 7-1/8" x 8"	10	13 lbs	DSB808	50	19 6
QSB810CL	17-7/8" x 11-1/8" x 8"	16-1/2" x 10" x 8"	8	13 lbs	DSB810	50	29 8
QSB805CL	23-5/8" x 4-3/8" x 8"	22-1/8" x 3" x 8"	16	15 lbs	DSB805	50	13 4
QSB806CL	23-5/8" x 6-5/8" x 8"	22-1/8" x 5-1/2" x 8"	8	11 lbs	DSB806	50	21 8
QSB814CL	23-5/8" x 8-3/8" x 8"	22-1/8" x 7-1/8" x 8"	6	11 lbs	DSB814	50	24 8
QSB816CL	23-5/8" x 11-1/8" x 8"	22-1/8" x 10" x 8"	6	12 lbs	DSB816	50	35 16



Dividers and Bin Cups

Optional black dividers fit snugly, horizontally across bins to create compartments. Each bin accepts up to 7 dividers.

Bin cups have a raised, slotted label holder for easy parts identification. The entire bin cup may be removed for easy part retrieval. Available in 2 sizes and 2 colors.

Available in: Blue Yellow

MODEL NO.	OUTSIDE DIMENSIONS L" x W" x H"	CTN QTY	CTN WGT
QBC111	3-1/4" x 1-3/4" x 3"	48	4 lbs
QBC112	5-1/8" x 2-3/4" x 3"	48	7 lbs



COMPLETE PACKAGES WITH BINS



MOBILIZE YOUR WIRE SHELVING

DB - Donut Bumper

Non-marking donut bumper used to protect walls and help cushion impact.

WR-00H (Mobile Kit)*

Set of four swivel thermoplastic resin 5" x 1-1/4" casters, two with brakes. 1,200 lb. load capacity.

*Mobile kits recommended only for shelves 18" and deeper.



WR4-39-1236-802CL



WR8-802CL

QUANTUM IS CLEARLY YOUR STORAGE SOLUTION



1239-SB807CL



1275-SB807CL

Clear-View Complete Bin Center

Complete bin systems are available with 4 different size bin options on a 12"W x 36"L x 39"H unit. This all-purpose bin center is an economical high density storage system that provides easy visibility to stored contents. Bins available in Clear.

Bins available in: Clear **800 lb. LOAD CAPACITY PER SHELF**

MODEL NO.	NO. OF BINS	BIN DIMENSIONS L" x W" x H"	SHIP WGT
12"W x 36"L x 39"H - 4 Shelf Systems			
WR4-39-1236-801CL	24 QSB801CL	11-5/8" x 4-3/8" x 8"	80 lbs
WR4-39-1236-802CL	15 QSB802CL	11-5/8" x 6-5/8" x 8"	78 lbs
WR4-39-1236-807CL	12 QSB807CL	11-5/8" x 8-3/8" x 8"	77 lbs
WR4-39-1236-809CL	9 QSB809CL	11-5/8" x 11-1/8" x 8"	77 lbs

Clear-View STORE-MAX 8" Shelf Bin Wire Shelving Systems - Complete Packages

Bins available in: Clear **800 lb. LOAD CAPACITY PER SHELF**

MODEL NO.	NO. OF BINS	BIN DIMENSIONS L" x W" x H"	SHIP WGT
12"W x 36"L x 74"H - 8 Shelf Systems			
WR8-801CL	49 QSB801CL	11-5/8" x 4-3/8" x 8"	100 lbs
WR8-802CL	35 QSB802CL	11-5/8" x 6-5/8" x 8"	103 lbs
WR8-807CL	28 QSB807CL	11-5/8" x 8-3/8" x 8"	102 lbs
WR8-809CL	21 QSB809CL	11-5/8" x 11-1/8" x 8"	101 lbs
18"W x 36"L x 74"H - 8 Shelf Systems			
WR8-803CL	49 QSB803CL	17-7/8" x 4-3/8" x 8"	150 lbs
WR8-804CL	35 QSB804CL	17-7/8" x 6-5/8" x 8"	142 lbs
WR8-808CL	28 QSB808CL	17-7/8" x 8-3/8" x 8"	138 lbs
WR8-810CL	21 QSB810CL	17-7/8" x 11-1/8" x 8"	141 lbs
24"W x 36"L x 74"H - 8 Shelf Systems			
WR8-805CL	49 QSB805CL	23-5/8" x 4-3/8" x 8"	194 lbs
WR8-806CL	35 QSB806CL	23-5/8" x 6-5/8" x 8"	177 lbs
WR8-814CL	28 QSB814CL	23-5/8" x 8-3/8" x 8"	176 lbs
WR8-816CL	21 QSB816CL	23-5/8" x 11-1/8" x 8"	169 lbs

Clear-View STORE-MAX 8" Shelf Bin Steel Shelving Systems - Complete Packages

Bins available in: Clear **400 lb. LOAD CAPACITY PER SHELF**

MODEL NO.	NO. OF BINS	BIN DIMENSIONS L" x W" x H"	SHIP WGT
12"D x 36"W x 75"H - 8 Shelf Systems			
1275-SB801CL	56 QSB801CL	11-5/8" x 4-3/8" x 8"	111 lbs
1275-SB802CL	35 QSB802CL	11-5/8" x 6-5/8" x 8"	103 lbs
1275-SB807CL	28 QSB807CL	11-5/8" x 8-3/8" x 8"	100 lbs
1275-SB809CL	21 QSB809CL	11-5/8" x 11-1/8" x 8"	98 lbs
12"D x 36"W x 39"H - 4 Shelf Systems			
1239-SB801CL	24 QSB801CL	11-5/8" x 4-3/8" x 8"	56 lbs
1239-SB802CL	15 QSB802CL	11-5/8" x 6-5/8" x 8"	52 lbs
1239-SB807CL	12 QSB807CL	11-5/8" x 8-3/8" x 8"	51 lbs
1239-SB809CL	9 QSB809CL	11-5/8" x 11-1/8" x 8"	50 lbs
18"D x 36"W x 75"H - 8 Shelf Systems			
1875-SB803CL	56 QSB803CL	17-7/8" x 4-3/8" x 8"	156 lbs
1875-SB804CL	35 QSB804CL	17-7/8" x 6-5/8" x 8"	141 lbs
1875-SB808CL	28 QSB808CL	17-7/8" x 8-3/8" x 8"	142 lbs
1875-SB810CL	21 QSB810CL	17-7/8" x 11-1/8" x 8"	139 lbs
18"D x 36"W x 39"H - 4 Shelf Systems			
1839-SB803CL	24 QSB803CL	17-7/8" x 4-3/8" x 8"	77 lbs
1839-SB804CL	15 QSB804CL	17-7/8" x 6-5/8" x 8"	70 lbs
1839-SB808CL	12 QSB808CL	17-7/8" x 8-3/8" x 8"	71 lbs
1839-SB810CL	9 QSB810CL	17-7/8" x 11-1/8" x 8"	69 lbs



Genuine stack and nest totes



9 SIZES AVAILABLE

NEW CLEAR VIEW

CLEAR TOTES & LIDS

These heavy-duty, tough, and dependable stack and nest totes are the ultimate reusable container for storing and transporting your valuable items in any application. These proven containers are available in nine sizes for efficiency and inventory control.

Available in: Clear

MODEL NO.	OUTSIDE DIMENSIONS L" x W" x H"	INSIDE DIMENSIONS					CAPACITY (CU FT)	CTN QTY	CTN WGT	LID	CTN QTY	
		A	B	C	D	E						
snt180CL	18" x 11" x 6"	10"	16"	15-1/4"	9-3/8"	5-7/8"	0.50	6	12 lbs	LID181CL	6	
snt185CL	18" x 11" x 9"	10"	16"	15-1/8"	9-1/8"	8-7/8"	0.76	6	15 lbs	LID181CL	6	
snt190CL	19-1/2" x 15-1/2" x 10"	14-1/2"	17"	16"	13-1/4"	9-7/8"	1.20	6	23 lbs	LID191CL	6	
snt195CL	19-1/2" x 15-1/2" x 13"	14-1/2"	17"	15-7/8"	13-3/8"	12-7/8"	1.70	6	26 lbs	LID191CL	6	
snt200CL	19-1/2" x 13-1/2" x 8"	12-3/8"	17-7/8"	16-3/8"	11-1/2"	7-7/8"	0.80	6	19 lbs	LID201CL	6	
snt225CL	23-1/2" x 19-1/2" x 10"	18-1/4"	20-7/8"	19-3/8"	16-7/8"	9-7/8"	2.00	3	18 lbs	LID231CL	3	
snt230CL	23-1/2" x 19-1/2" x 13"	18-1/8"	20-7/8"	19-1/2"	16-7/8"	12-7/8"	2.60	3	22 lbs	LID231CL	3	
snt240CL	23-1/2" x 15-1/2" x 12"	14-1/4"	20-7/8"	19-5/8"	13"	11-7/8"	1.70	3	18 lbs	LID241CL	3	
snt300CL	29-1/2" x 19-1/2" x 15"	18-1/4"	26-5/8"	25-1/8"	16-5/8"	14-7/8"	3.70	3	31 lbs	LID301CL	3	
snh010	Clear Label Holder - 3" x 5" (Fits all tote sizes)								6	1 lb	-	-



COMPLETE PACKAGES WITH BINS

PERFORMANCE FEATURES:

- Available in 9 sizes
- Standard color: Clear
- Totes are injection molded from high-density tri-clear virgin-grade polypropylene material that complies with the USDA and FDA regulations
- stack and nest totes will not corrode, bend out of shape, are unaffected by chemicals and are waterproof
- Reusable container will stack with or without lids for maximum storage and shipping
- snt's have the unique ability to stack or they can be turned 180° to nest when empty saving valuable space
- Optional lids for totes can be secured with nylon ties
- Textured bottoms ensure safe and easy, non-slip grip in transit on conveyors

QUANTUM IS CLEARLY YOUR STORAGE SOLUTION

NEW BIN PACKAGES

Genuine stack and nest totes Wire Shelving Systems - Complete Packages

Offering a generous 600-800 lb. load capacity per shelf, this chrome wire shelving system with totes is a must have for archival storage, heavy-duty parts organization or inventory control applications. With three packages to choose from offering clear-view bins, this system can be used just about anywhere. System may be made mobile with the addition of the WR-00H mobile kit. See pg. 66 for additional information and to order optional accessories.

Bins available in: Clear

600-800 lb. LOAD CAPACITY PER SHELF

MODEL NO.	NO. OF SHELVES	NO. OF BINS	BIN DIMENSIONS L" x W" x H"	SHIP WGT
18"W x 48"L x 74"H - Wire Shelving Systems with stack and nest totes - Totes are available in Clear				
WR9-36180CL	9	36 snt180CL	18" x 11" x 6"	178 lbs
WR6-24185CL	6	24 snt185CL	18" x 11" x 9"	136 lbs
24"W x 66"L x 63"H - Wire Shelving System with stack and nest totes - Totes are available in Clear				
WR4-12225CL	4	12 snt225CL	23-1/2" x 19-1/2" x 10"	170 lbs



WR6-24185CL



MOBILIZE YOUR WIRE SHELVING

DB - Donut Bumper
Non-marking donut bumper used to protect walls and help cushion impact.

WR-00H (Mobile Kit)
Set of four swivel thermoplastic resin 5" x 1-1/4" casters, two with brakes. Can be used with all units shown. 1,200 lb. load capacity.



Clear-View Dividable Grid Containers



Heavy-duty Dividable Grid Containers can be used for storage, kitting and distribution applications. These containers offer the safest and most efficient method for compartmentalizing and protecting small to medium sized items. Dividers allow you to customize the container's interior to meet your exact needs. Dividers: Gray. Containers and covers are available in Clear.

Available in: Clear

Table with 5 columns: MODEL NO., OUTSIDE DIMENSIONS, INSIDE DIMENSIONS, CTN QTY, CTN WGT. Lists various container models like DG91025CL, DG91035CL, etc.



NEW SIZES



Clear Dividable Grid Container Shown with optional cover see pg. 65 (Sold separately)



Clear Dividable Grid Container Shown with optional dividers see pg. 65 (Sold separately)



WR7-92080CL

COMPLETE PACKAGES WITH BINS



MOBILIZE YOUR WIRE SHELVING

DB - Donut Bumper Non-marking donut bumper used to protect walls and help cushion impact.

WR-00H (Mobile Kit) Set of four swivel thermoplastic resin 5" x 1-1/4" casters, two with brakes. Can be used with all units shown. 1,200 lb. load capacity.

Clear-View Dividable Grid Container Wire Shelving Systems - Complete Packages

Durable chrome wire shelving combined with Quantum's Clear-View Dividable Grid Containers. These containers allow for multiple compartment configurations within each bin. Offering four different packages, these systems are ideal for small, medium and large parts storage. System may be made mobile with the addition of the WR-00H mobile kit. See pg. 65 for additional information and to order optional accessories.

Bins available in: Clear 600-800 lb. LOAD CAPACITY PER SHELF

Table with 5 columns: MODEL NO., NO. OF SHELVES, NO. OF BINS, BIN DIMENSIONS, SHIP WGT. Lists shelving system packages like WR9-92060CL, WR7-92080CL, etc.

Bin Carts

Modular carts are the ultimate work-in-process and transport cart. Dividable grids slide easily in and out and with their ability to be divided into multiple compartments with long and short dividers, see pg. 65 for dividers and label holders. Double and Triple Bay Carts are also available, see pg. 133. Dividable grids are available in Clear. Cart Finish: Chrome

Table with 4 columns: MODEL NO., NO. OF BINS, BIN DIMENSIONS, SHIP WGT. Lists bin cart models like BC212434M1CL, BC212439M2CL, etc.

QUANTUM IS CLEARLY YOUR STORAGE SOLUTION



BC212434M1CL



Clear Dust Cover Acrylic Inlays

Clear Acrylic Dust Cover Inlays keep stored items visible while protecting against airborne dust and other contaminants. Cover lays inside on recessed rim of container.

Table with 3 columns: MODEL NO., FITS BIN MODEL NO., CTN QTY. Lists dust cover models like DDC91000CL, DDC92000CL, etc.



10 SIZES AND 5 COLORS AVAILABLE

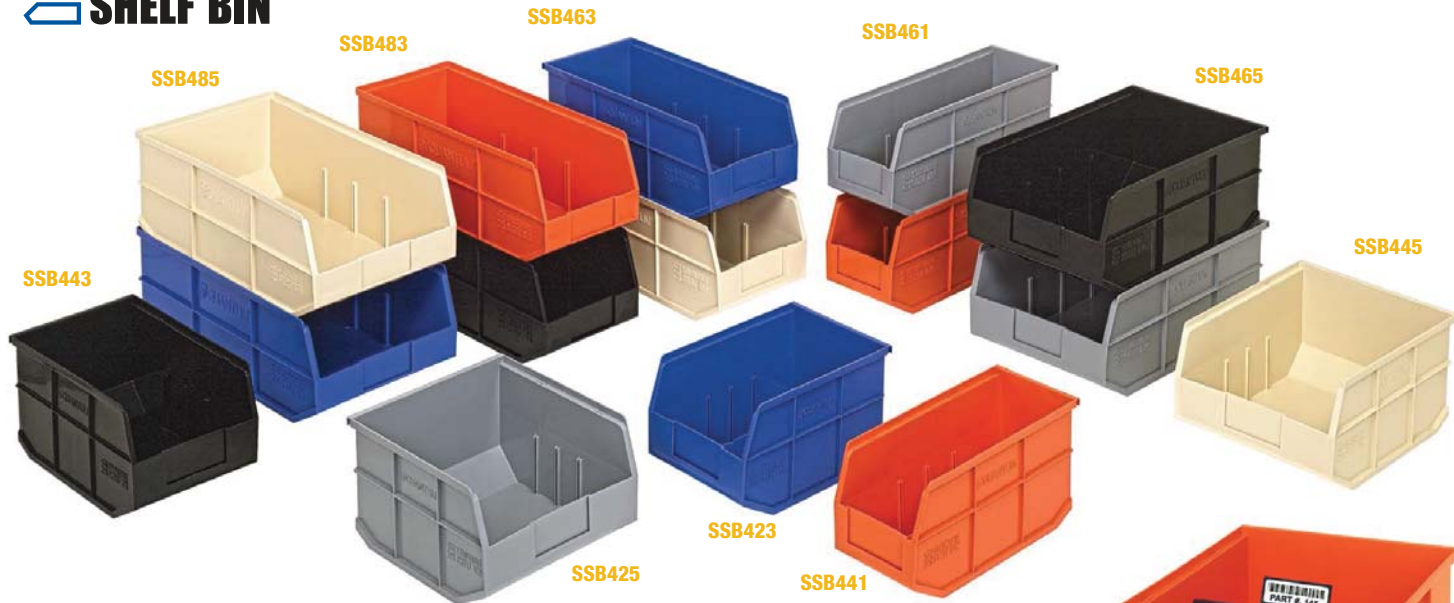

Stackable Shelf Bins



QUANTUM STORAGE SYSTEMS
exclusive



STACKABLE SHELF BIN
Shown with optional Divider and DLT-6 Divider Label Tabs attach to existing dividers to improve the visibility of bin labels and scanning of barcodes. Package of 6. (Dividers and Label Tabs sold separately)

Quantum's exclusive Stackable Shelf Bins are an industry first and are ideal for medium size and large or heavy item storage. These strong, durable polypropylene bins are available in 4 lengths and 3 widths. 12", 14" and 18" deep bins have a built in rear hanger which allows bin to hang from louvered panels and rails. Bins have a raised front opening when compared to any like product allowing you to truly maximize the complete bin's storage capacity. Optional cross dividers allow flexibility and keep parts organized. Waterproof bins resist rust and corrosion. Large molded in front label slots for ID labels. Autoclavable up to 250°F and resistant to extreme cold.

Available in: ● Blue ● Gray ● Ivory ● Black ● Orange

MODEL NO.	OUTSIDE DIMENSIONS L" x W" x H"	INSIDE DIMENSIONS L" x W" x H"	X"	CTN QTY	CTN WGT	DIVIDER	CTN QTY	CTN WGT	CLEAR LABEL HOLDER & INSERT
SSB423	12" x 8-1/4" x 7"	11-1/2" x 7-3/8" x 6-1/2"	7-1/2"	6	9 lbs	DSS403	6	1 lb	LTR-2400
SSB425	12" x 11" x 7"	11-1/2" x 10-1/8" x 6-1/2"	7-1/2"	6	11 lbs	DSS405	6	2 lbs	LTR-2400
SSB441	14" x 6" x 7"	13-1/2" x 5-3/8" x 6-1/2"	9-3/8"	6	8 lbs	DSS401	6	1 lb	LTR-2400
SSB443	14" x 8-1/4" x 7"	13-1/2" x 7-3/8" x 6-1/2"	9-3/8"	12	18 lbs	DSS403	6	1 lb	LTR-2400
SSB445	14" x 11" x 7"	13-1/2" x 10-1/8" x 6-1/2"	9-3/8"	6	12 lbs	DSS405	6	2 lbs	LTR-2400
SSB461	18" x 6" x 7"	17-1/2" x 5-3/8" x 6-1/2"	13-1/2"	6	11 lbs	DSS401	6	1 lb	LTR-2400
SSB463	18" x 8-1/4" x 7"	17-1/2" x 7-3/8" x 6-1/2"	13-3/8"	6	12 lbs	DSS403	6	1 lb	LTR-2400
SSB465	18" x 11" x 7"	17-1/2" x 10-1/8" x 6-1/2"	13-3/8"	6	15 lbs	DSS405	6	2 lbs	LTR-2400
SSB483*	20-1/2" x 8-1/4" x 7"	20" x 7-3/8" x 6-1/2"	15-7/8"	6	14 lbs	DSS403	6	1 lb	LTR-2400
SSB485*	20-1/2" x 11" x 7"	20" x 10-1/8" x 6-1/2"	15-7/8"	6	17 lbs	DSS405	6	2 lbs	LTR-2400

*Do not have rear hanger

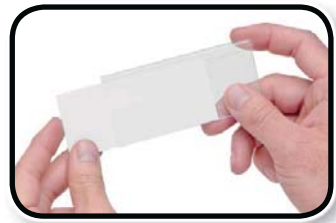

LTR-2400
Clear Label Holder and Insert
Package of 25.

PERFORMANCE FEATURES:

- Available in 10 sizes
- Standard colors: Blue, Gray, Ivory, Black and Orange (additional colors available on request, subject to upcharge and minimum runs)
- Bins are made from heavy-duty, virgin, high density FDA approved polypropylene
- Large label slot provide easy label insertion and parts identification
- Extra wide stacking ledge assures stability for high stacking
- Reinforced design adds strength and prevents spreading
- Will not rust or corrode, unaffected by weak acids and alkalis, and are waterproof
- Autoclavable up to 250°F

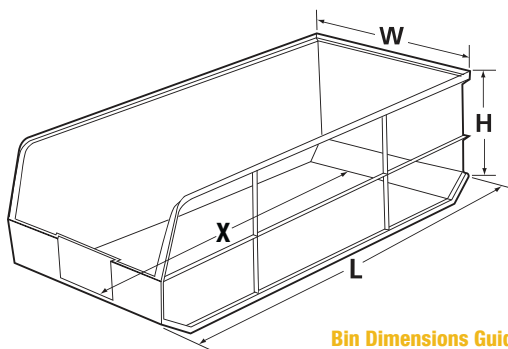

Bin Dimensions Guide
L (length) W (width) H (height)
X (inside length)



2475-485
24"D x 36"W x 75"H
8 shelves and 21 SSB485
20-1/2"L x 11"W x 7"H bins

Stackable Shelf Bin Steel Shelving Systems - Complete Packages

Bins available in: ● Blue ● Gray ● Ivory ● Black ● Orange (One color per unit)

MODEL NO.	OUTSIDE DIMENSIONS D" x W" x H"	NO. OF SHELVES	NO. OF BINS	BIN DIMENSIONS L" x W" x H"	SHIP WGT
1275-423	12" x 36" x 75"	8	28 SSB423	12" x 8-1/4" x 7"	129 lbs
1275-425	12" x 36" x 75"	8	21 SSB425	12" x 11" x 7"	126 lbs
1275-441	12" x 36" x 75"	8	35 SSB441	14" x 6" x 7"	134 lbs
1275-443	12" x 36" x 75"	8	28 SSB443	14" x 8-1/4" x 7"	129 lbs
1275-445	12" x 36" x 75"	8	21 SSB445	14" x 11" x 7"	129 lbs
1875-461	18" x 36" x 75"	8	35 SSB461	18" x 6" x 7"	173 lbs
1875-463	18" x 36" x 75"	8	28 SSB463	18" x 8-1/4" x 7"	165 lbs
1875-465	18" x 36" x 75"	8	21 SSB465	18" x 11" x 7"	165 lbs
2475-483	24" x 36" x 75"	8	28 SSB483	20-1/2" x 8-1/4" x 7"	197 lbs
2475-483485	24" x 36" x 75"	8	12 SSB483 12 SSB485	20-1/2" x 8-1/4" x 7" 20-1/2" x 11" x 7"	195 lbs
2475-485	24" x 36" x 75"	8	21 SSB485	20-1/2" x 11" x 7"	194 lbs

400 lb. LOAD CAPACITY PER SHELF

COMPLETE PACKAGES WITH BINS



MOBILIZE YOUR WIRE SHELVING

DB - Donut Bumper
Non-marking donut bumper used to protect walls and help cushion impact.

WR-00H (Mobile Kit)*
Set of four swivel thermoplastic resin 5" x 1-1/4" casters, two with brakes. 1,200 lb. load capacity. *Mobile kits recommended only for shelves 18" and deeper.



WR8-463
18"W x 36"L x 74"H
8 shelves and 28 SSB463
18"L x 8-1/4"W x 7"H bins



Stackable Shelf Bin Wire Shelving Systems - Complete Packages

Bins available in: ● Blue ● Gray ● Ivory ● Black ● Orange (One color per unit)

MODEL NO.	OUTSIDE DIMENSIONS W" x L" x H"	NO. OF SHELVES	NO. OF BINS	BIN DIMENSIONS L" x W" x H"	SHIP WGT
WR8-423	12" x 36" x 74"	8	28 SSB423	12" x 8-1/4" x 7"	114 lbs
WR8-425	12" x 36" x 74"	8	21 SSB425	12" x 11" x 7"	107 lbs
WR8-441	14" x 36" x 74"	8	35 SSB441	14" x 6" x 7"	136 lbs
WR8-443	14" x 36" x 74"	8	28 SSB443	14" x 8-1/4" x 7"	129 lbs
WR8-445	14" x 36" x 74"	8	21 SSB445	14" x 11" x 7"	122 lbs
WR8-461	18" x 36" x 74"	8	35 SSB461	18" x 6" x 7"	190 lbs
WR8-463	18" x 36" x 74"	8	28 SSB463	18" x 8-1/4" x 7"	180 lbs
WR8-465	18" x 36" x 74"	8	21 SSB465	18" x 11" x 7"	184 lbs
WR8-483	21" x 36" x 74"	8	28 SSB483	20-1/2" x 8-1/4" x 7"	198 lbs
WR8-483485	21" x 36" x 74"	8	12 SSB483 12 SSB485	20-1/2" x 8-1/4" x 7" 20-1/2" x 11" x 7"	199 lbs
WR8-485	21" x 36" x 74"	8	21 SSB485	20-1/2" x 11" x 7"	198 lbs

HULK containers

10 SIZES AND 4 COLORS AVAILABLE

CLEARVIEW BINS
AVAILABLE on pg. 22



NEW
SIZE



QUS957
Shown with optional cross divider



REAR LARGE HANDLE
Molded onto back of containers makes them easy to carry!



AL-23
2" x 3-1/2"
Adhesive clear label holder and inserts.
Package of 24
(Sold separately)



POLYMER DOLLY
DLY-3018 Dolly with padded rubber trim, available in Blue. Dimensions 30"L x 18"W. Set of four 4" x 1-1/4" non-marking swivel poly casters, 1,000 lb. load capacity. (Bin sold separately)



MOBILE HULK CONTAINER
Ideal for transport of heavy and bulky parts. Bin comes with 4 swivel, 3" polyurethane casters, all with brakes, allowing up to 250 lb. mobile load capacity



ATTACHED PULL RING
allows dolly to be pulled with ease

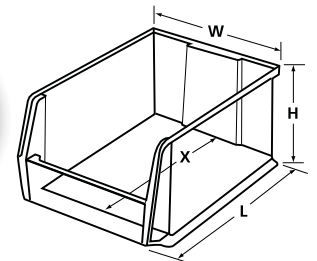

Bin Dimensions Guide
L (length) W (width)
H (height) X (inside length)

HULK 24" Containers



Organize and store your large and bulky items with these strong injection molded polypropylene, stackable containers. These extra large stacking containers offer a generous 2 feet in length to store your larger items. These huge stack bins are ideal for heavy-duty, extra deep shelving and are available in a variety of widths and heights. Heavy-duty front, back and side grips allow for easy handling. Optional clear styrene plastic window increases bin capacity and provides a quick view of the bin contents. Optional dividers maximize flexibility and keep contents organized. Wide stacking ledge and anti-slide lock keep stacked bins steady and prevent forward shifting. Waterproof bins are corrosion free. Bins are autoclavable up to 250°F and are resistant to extreme cold. See **pg. 22** to order Clear bins.

Available in: ● Blue ● Red ● Yellow ● Clear

MODEL NO.	OUTSIDE DIMENSIONS L" x W" x H"	INSIDE DIMENSIONS L" x W" x H"	X"	CTN QTY	CTN WGT	CLEAR WINDOW	CTN QTY	DIVIDER & CROSS DIVIDER	CTN QTY	CLEAR LABEL HOLDER & INSERT	CTN QTY
QUS950	23-7/8" x 8-1/4" x 7"	21-7/8" x 6-1/4" x 6-5/8"	19"	6	18 lbs	WUS950/970	6	DUS950	6	-	-
QUS951	23-7/8" x 8-1/4" x 9"	21-7/8" x 6-1/4" x 8-3/4"	18-3/4"	6	21 lbs	WUS951	6	DUS951	6	-	-
QUS952	23-7/8" x 11" x 7"	21-7/8" x 9" x 6-7/8"	19"	4	14 lbs	WUS952	4	DUS952	4	-	-
QUS953	23-7/8" x 11" x 10"	21-1/2" x 8-7/8" x 9-3/4"	18-3/4"	4	18 lbs	WUS953/973	4	DUS953	4	-	-
QUS954	23-7/8" x 16-1/2" x 11"	21-7/8" x 14-1/4" x 10-3/4"	18-3/4"	1	7 lbs	WUS954/974	1	DUS954	1	AL-23	24
QUS964MOB*	23-7/8" x 16-1/2" x 11"	21-7/8" x 14-1/4" x 10-3/4"	18-3/4"	1	9 lbs	WUS954/974	1	DUS954	1	AL-23	24
QUS955	23-7/8" x 18-1/4" x 12"	21-1/2" x 16" x 11-3/4"	17-3/4"	1	8 lbs	WUS955/975	1	DUS955	1	AL-23	24
QUS965MOB*	23-7/8" x 18-1/4" x 12"	21-1/2" x 16" x 11-3/4"	17-3/4"	1	10 lbs	WUS955/975	1	DUS955	1	AL-23	24
QUS957	NEW 23-7/8" x 22-1/2" x 12"	21-1/8" x 20-1/2" x 11-3/8"	18"	1	8 lbs	WUS957	1	DUS957 CRDUS957	1	AL-23	24
QUS967MOB*	NEW 23-7/8" x 22-1/2" x 12"	21-1/8" x 20-1/2" x 11-3/8"	18"	1	10 lbs	WUS957	1	DUS957 CRDUS957	1	AL-23	24

*With caster, overall height for mobile container will be increased by 3"



350 lb. LOAD CAPACITY PER SHELF

HULK 24" Container Steel Shelving Systems - Complete Packages



2475-950
24"D x 36"W x 75"H
8 shelves and 28 QUS950
23-7/8"L x 8-1/4"W x 7"H bins



2475-951
24"D x 36"W x 75"H
7 shelves and 24 QUS951
23-7/8"L x 8-1/4"W x 9"H bins



2475-952
24"D x 36"W x 75"H
8 shelves and 21 QUS952
23-7/8"L x 11"W x 7"H bins



2475-953
24"D x 36"W x 75"H
6 shelves and 15 QUS953
23-7/8"L x 11"W x 10"H bins



2475-954
24"D x 36"W x 75"H
6 shelves and 10 QUS954
23-7/8"L x 16-1/2"W x 11"H bins



2475-950952
24"D x 36"W x 75"H
8 shelves and 12 QUS950
23-7/8"L x 8-1/4"W x 7"H bins
and 12 QUS952
23-7/8"L x 11"W x 7"H bins



2475-953954
24"D x 36"W x 75"H
6 shelves and 9 QUS953
23-7/8"L x 11"W x 10"H bins
and 4 QUS954
23-7/8"L x 16-1/2"W x 11"H bins



2475-20-MIX
24"D x 36"W x 75"H
7 shelves and 8 QUS950
23-7/8"L x 8-1/4"W x 7"H bins
and 3 QUS952
23-7/8"L x 11"W x 7"H bins
and 4 QUS951
23-7/8"L x 8-1/4"W x 9"H bins
and 3 QUS953
23-7/8"L x 11"W x 10"H bins
and 2 QUS954
23-7/8"L x 16-1/2"W x 11"H bins



COMPLETE PACKAGES WITH BINS



Bins available in: ● Blue ● Red ● Yellow ● Clear (One color per unit)



HULK 24" Container Wire Shelving Systems - Complete Packages

800 lb. LOAD CAPACITY PER SHELF



WR8-950
24"W x 36"L x 74"H
8 shelves and 28 QUS950
23-7/8"L x 8-1/4"W x 7"H bins



WR7-951
24"W x 36"L x 74"H
7 shelves and 24 QUS951
23-7/8"L x 8-1/4"W x 9"H bins



WR8-952
24"W x 36"L x 74"H
8 shelves and 21 QUS952
23-7/8"L x 11"W x 7"H bins



WR6-953
24"W x 36"L x 74"H
6 shelves and 15 QUS953
23-7/8"L x 11"W x 10"H bins



WR6-954
24"W x 36"L x 74"H
6 shelves and 10 QUS954
23-7/8"L x 16-1/2"W x 11"H bins



WR5-955
24"W x 42"L x 74"H
5 shelves and 8 QUS955
23-7/8"L x 18-1/4"W x 12"H bins



NEW
WR6-957
24"W x 48"L x 74"H
6 shelves and 10 QUS957
23-7/8"L x 22-1/2"W x 12"H bins



WR7-20-MIX
24"W x 36"L x 74"H
7 shelves and 8 QUS950
23-7/8"L x 8-1/4"W x 7"H bins
and 3 QUS952
23-7/8"L x 11"W x 7"H bins
and 4 QUS951
23-7/8"L x 8-1/4"W x 9"H bins
and 3 QUS953
23-7/8"L x 11"W x 10"H bins
and 2 QUS954 bins
23-7/8"L x 16-1/2"W x 11"H bins



MOBILIZE YOUR WIRE SHELVING

DB - Donut Bumper
Non-marking donut bumper used to protect walls and help cushion impact.

WR-00H (Mobile Kit)
Set of four swivel thermoplastic resin 5" x 1-1/4" casters, two with brakes. Can be used with all units shown. 1,200 lb. load capacity.



AVAILABLE on pg. 22



Bins available in: ● Blue ● Red ● Yellow ● Clear (One color per unit)



14 SIZES AND 3 COLORS AVAILABLE

150 lb. STACK CAPACITY PER BINS

HEAVY-DUTY

HULK containers

QUS970



29-7/8" L

QUS973



QUS974

QUS976



QUS975

ADHESIVE CLEAR LABEL HOLDER AND INSERTS

AL-23

2" x 3-1/2"

(Fits bins 12"H and shorter)

AL-35

3" x 5"

(Fits bins 15"H and taller)

Package of 24 (Sold separately)



QUS997

35-7/8" L

REAR LARGE HANDLE

Molded onto back of containers makes them easy to carry!



CLEAR PLASTIC WINDOW FRONT

Increases bin capacity and provides a quick view of the bin contents. (Sold separately)

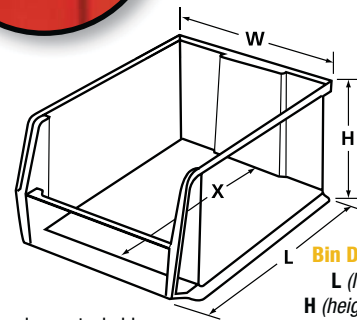

Bin Dimensions Guide

L (length) W (width)

H (height) X (inside length)

HULK 30" & 36" Containers



Organize and store your large and bulky items with these strong injection molded high impact polypropylene, stackable containers. These extra large stacking containers offer a generous 2-1/2 - 3 feet in length to store your larger items. These huge stack bins are ideal for heavy-duty, extra deep shelving and are available in a variety of widths and heights. Heavy-duty front, back and side grips allow for easy handling. Wide stacking ledge and anti-slide lock keep stacked bins steady and prevent forward shifting. Waterproof bins are corrosion-free. Bins are autoclavable up to 250°F and are resistant to extreme cold.

Available in: ● Blue ● Red ● Yellow

MODEL NO.	OUTSIDE DIMENSIONS L" x W" x H"	INSIDE DIMENSIONS L" x W" x H"	X"	CTN QTY	CTN WGT	CLEAR WINDOW	CTN QTY DIVIDER	CTN QTY
HULK 30" Containers								
QUS970	29-7/8" x 8-1/4" x 7"	27-7/8" x 6-1/4" x 6-3/4"	25"	6	23 lbs	WUS950/970	6	DUS970 6
QUS973	29-7/8" x 11" x 10"	27-7/8" x 8-7/8" x 9-5/8"	24-3/4"	4	22 lbs	WUS953/973	4	DUS973 4
QUS974	29-7/8" x 16-1/2" x 11"	27-5/8" x 14-1/4" x 10-5/8"	24-3/4"	1	8 lbs	WUS954/974	1	DUS974 1
QUS984MOB	29-7/8" x 16-1/2" x 11"	27-5/8" x 14-1/4" x 10-5/8"	24-3/4"	1	10 lbs	WUS954/974	1	DUS974 1
QUS975	29-7/8" x 18-1/4" x 12"	27-1/2" x 16" x 11-3/4"	23-3/4"	1	9 lbs	WUS955/975	1	DUS975 1
QUS985MOB	29-7/8" x 18-1/4" x 12"	27-1/2" x 16" x 11-3/4"	23-3/4"	1	11 lbs	WUS955/975	1	DUS975 1
QUS976	29-7/8" x 16-1/2" x 15"	27-3/8" x 14" x 14-3/4"	23-1/2"	1	10 lbs	WUS976	1	DUS976 1
QUS986MOB	29-7/8" x 16-1/2" x 15"	27-3/8" x 14" x 14-3/4"	23-1/2"	1	12 lbs	WUS976	1	DUS976 1
HULK 36" Containers								
QUS993	35-7/8" x 16-1/2" x 17-1/2"	33-1/8" x 14" x 17-1/4"	28-1/4"	1	14 lbs	-	-	DUS993 1
QUS994MOB	35-7/8" x 16-1/2" x 17-1/2"	33-1/8" x 14" x 17-1/4"	28-1/4"	1	16 lbs	-	-	DUS993 1
QUS995	35-7/8" x 19-7/8" x 17-1/2"	33-1/8" x 17-3/8" x 17-1/4"	28-1/4"	1	15 lbs	-	-	DUS995 1
QUS996MOB	35-7/8" x 19-7/8" x 17-1/2"	33-1/8" x 17-3/8" x 17-1/4"	28-1/4"	1	17 lbs	-	-	DUS995 1
QUS997	35-7/8" x 23-7/8" x 17-1/2"	33-1/4" x 21-3/8" x 17-1/4"	28-1/4"	1	18 lbs	-	-	DUS997 1
QUS998MOB	35-7/8" x 23-7/8" x 17-1/2"	33-1/4" x 21-3/8" x 17-1/4"	28-1/4"	1	20 lbs	-	-	DUS997 1

*With caster, overall height for mobile container will be increased by 3"





HULK 30" Container Wire Shelving Systems - Complete Packages

700 lb. LOAD CAPACITY PER SHELF



WR8-970
30"W x 36"L x 74"H
8 shelves and 28 QUS970
29-7/8"L x 8-1/4"W x 7"H bins



WR6-973
30"W x 36"L x 74"H
6 shelves and 15 QUS973
29-7/8"L x 11"W x 10"H bins



WR6-974
30"W x 36"L x 74"H
6 shelves and 10 QUS974
29-7/8"L x 16-1/2"W x 11"H bins



WR6-973974
30"W x 36"L x 74"H
6 shelves and 9 QUS973
29-7/8"L x 11"W x 10"H bins
and 4 QUS974
29-7/8"L x 16-1/2"W x 11"H bins

HULK containers

**QUANTUM CHROME
WIRE SHELVING
SYSTEMS COMPLETE
WITH BINS**



WR5-975
30"W x 42"L x 74"H
5 shelves and 8 QUS975
29-7/8"L x 18-1/4"W x 12"H bins



MOBILIZE YOUR WIRE SHELVING

DB - Donut Bumper
Non-marking donut bumper used to protect walls and help cushion impact.

WR-00H (Mobile Kit)
Set of four swivel thermoplastic resin 5" x 1-1/4" casters, two with brakes. Can be used with all units shown. 1,200 lb. load capacity.

Bins available in: ● Blue ● Red ● Yellow (One color per unit)



HULK 36" Container Wire Shelving Systems - Complete Packages



WR5-993
36"W x 36"L x 86"H
5 shelves and 8 QUS993
35-7/8"L x 16-1/2"W x 17-1/2"H bins

HULK
containers

ON
SHELVING

SIZE
DOES MATTER



WR5-995
36"W x 48"L x 86"H
5 shelves and 8 QUS995
35-7/8"L x 19-7/8"W x 17-1/2"H bins

600 lb.
LOAD CAPACITY
PER SHELF



MOBILIZE YOUR WIRE SHELVING

DB - Donut Bumper

Non-marking donut bumper used to protect walls and help cushion impact.

WR-00H (Mobile Kit)

Set of four swivel thermoplastic resin 5" x 1-1/4" casters, two with brakes. Can be used with all units shown. 1,200 lb. load capacity.



WR5-997
36"W x 60"L x 86"H
5 shelves and 8 QUS997
35-7/8"L x 23-7/8"W x 17-1/2"H bins

QUANTUM CHROME
WIRE SHELVING
SYSTEMS COMPLETE
WITH BINS

Bins available in: ● Blue ● Red ● Yellow (One color per unit)

RackBin 42" Containers



- These extra large bins offer a generous 42" (3-1/2 Feet) in length to store your larger items
- 42" length ensures no wasted space on 42" deep pallet rack
- Heavy-duty front, back and side grips allow for easy handling
- Wide stacking ledge and anti-slide lock keep stack bins steady and prevent forward shifting
- Have eight 1/4" drill hole pattern on bottom of bin for easy hole insertion for drainage and air circulation if needed
- Waterproof bins are corrosion free

180 lb.
STACK CAPACITY PER BIN

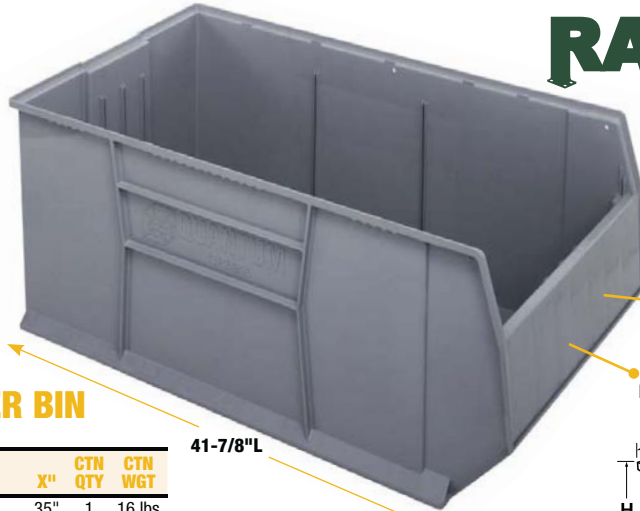

RACKBIN⁴²



AL-35
3" x 5"
Adhesive clear label holder and inserts. Package of 24 (Sold separately)

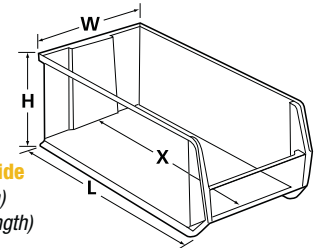

Bin Dimensions Guide
L (length) W (width)
H (height) X (inside length)

Available in: ● Blue ● Gray

MODEL NO.	OUTSIDE DIMENSIONS L" x W" x H"	INSIDE DIMENSIONS L" x W" x H"	X"	CTN QTY	CTN WGT
QRB166	41-7/8" x 16-1/2" x 17-1/2"	40-1/8" x 14" x 16-1/2"	35"	1	16 lbs
QRB176MOB	41-7/8" x 16-1/2" x 17-1/2"	40-1/8" x 14" x 16-1/2"	35"	1	18 lbs
QRB206	41-7/8" x 19-7/8" x 17-1/2"	40-1/8" x 17-3/8" x 16-1/2"	35"	1	17 lbs
QRB216MOB	41-7/8" x 19-7/8" x 17-1/2"	40-1/8" x 17-3/8" x 16-1/2"	35"	1	19 lbs
QRB246	41-7/8" x 23-7/8" x 17-1/2"	40-1/8" x 21-1/2" x 16-1/2"	35"	1	19 lbs
QRB256MOB	41-7/8" x 23-7/8" x 17-1/2"	40-1/8" x 21-1/2" x 16-1/2"	35"	1	21 lbs

41-7/8" L



*With caster, overall height for mobile container will be increased by 3"

3 SIZES AND 2 COLORS AVAILABLE



THE FIRST AND ONLY BIN DESIGNED SPECIFICALLY TO FIT PALLET RACK



RackBin 42" Container Wire Shelving Systems - Complete Packages



WRA86-2142C-206



WRA86-2136C-166



COMPLETE PACKAGES WITH BINS

Bins available in: ● Blue ● Gray (One color per unit)

MODEL NO.	DIMENSIONS W" x L" x H"	NO. OF CONTAINERS	CONTAINER SIZE L" x W" x H"	SHIP WGT
WRA86-2136C-166	42" x 36" x 86"	8 QRB166	41-7/8" x 16-1/2" x 17-1/2"	272 lbs
WRA86-2142C-206	42" x 42" x 86"	8 QRB206	41-7/8" x 19-7/8" x 17-1/2"	290 lbs
WRA86-2154C-166	42" x 54" x 86"	12 QRB166	41-7/8" x 16-1/2" x 17-1/2"	386 lbs



5 SIZES AND 6 COLORS AVAILABLE

CLEAR VIEW
AVAILABLE on pg. 23



QGH600



QGH700



QGH800



AL-23
2" x 3-1/2"
Adhesive clear label holder and inserts.
Package of 24
(Sold separately)



Curved lip and corners provide added strength

Large label holder allows for quick part identification
LTR-700
Clear label holders and laser label inserts slide into front label slot of all bins.
(Sold in packages of 25)



Smooth label area

Large and comfortable side grip handles allow for easy carrying and handling

150 lb. STACK CAPACITY PER BIN

Ribs on side of bin provide added stability when stacked

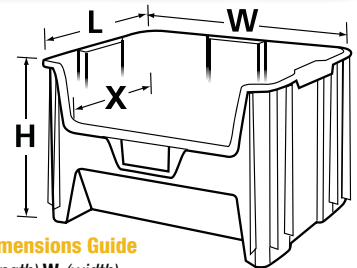

Bin Dimensions Guide
L (length) W (width)
H (height) X (inside length)

Giant Stack Containers



Multipurpose, wide open hopper front provides easy access for large part storage. Ideal for multiple applications in recycling, storing parts and components. This bin will stack up to 6 bins high creating a sturdy, tall storage system. Bins are injection molded from high density polypropylene, easy to clean, resist corrosion and are impervious to most chemicals. Large label holder allows for quick identification. Optional clear window front increases storage capacity and allows for quick identification of parts. Six 1/4" drill hole pattern on bottom of bin allow for easy hole insertion for drainage and air circulation. See **pg. 23** to order Clear Bins.

QGH700 available in: ● Blue ● Ivory ● Red ● Black ● Gray ● Clear
QGH600 and QGH800 available in: ● Blue ● Red ● Gray ● Clear

MODEL NO.	OUTSIDE DIMENSIONS L" x W" x H"	INSIDE DIMENSIONS L" x W" x H"	X"	CAP CU FT	CTN QTY	CTN WGT	WINDOW	CTN QTY
QGH600	17-1/2" x 10-7/8" x 12-1/2"	15-5/8" x 8" x 12-1/4"	13-1/2"	0.98	4	12 lbs	WGH600	4
QGH700*	15-1/4" x 19-7/8" x 12-7/16"	13-5/8" x 17-1/2" x 12-1/4"	11-1/2"	1.7	3	13 lbs	WGH700	3
QGH800	17-1/2" x 16-1/2" x 12-1/2"	15-5/8" x 13-3/4" x 12-1/4"	13-1/2"	1.6	2	8 lbs	WGH800	2

*Optional label for QGH700 is available, LGH700 (3 per package)

PERFORMANCE FEATURES:

- Extra thick side walls with reinforced ribs designed for strength, allowing for 150 lb. stack capacity per bin
- Large side grip handles
- Stacks 6 bins high
- Six 1/4" drill hole pattern on bottom of bin allows for easy hole insertion for drainage

Mobile Giant Stack Containers



- Ideal for transport of heavy and bulky parts
- Container comes with 4 swivel, 3" polyurethane casters, all with brakes, allowing for up to 250 lb. mobile load capacity
- Containers can stack with casters in place

QGH705MOB



QGH805MOB



QGH705MOB available in: ● Blue ● Ivory ● Red ● Black ● Gray ● Clear
QGH805MOB available in: ● Blue ● Red ● Gray ● Clear

MODEL NO.	OUTSIDE DIMENSIONS L" x W" x H"	INSIDE DIMENSIONS L" x W" x H"	X"	CAP CU FT	CTN QTY	CTN WGT	WINDOW	CTN QTY
QGH705MOB	15-1/4" x 19-7/8" x 12-7/16"	13-5/8" x 17-1/2" x 12-1/4"	11-1/2"	1.7	3	22 lbs	WGH700	3
QGH805MOB	17-1/2" x 16-1/2" x 12-1/2"	15-5/8" x 13-3/4" x 12-1/4"	13-1/2"	1.6	2	17 lbs	WGH800	2

*With caster, overall height for mobile container will be increased by 3"



CLEAR PLASTIC WINDOW FRONT
Increases bin capacity and provides a quick view of the bin contents.
(Sold separately)

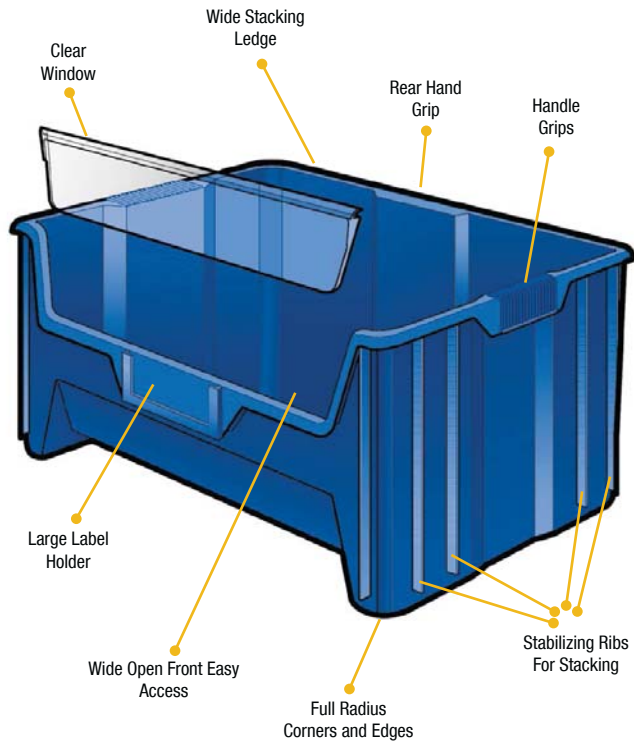

Giant Stack Container Storage Center - Complete Packages

Organize, store, and access your medium or large parts with this high capacity bin center. 400 lb. capacity per shelf and over 21 cubic feet of storage space. Powder coat finish ensures years of dependable use. Easy assembly.

CLEAR BINS VIEW AVAILABLE on pg. 23



QGH700CL



QSBU-700 18"D x 42"W x 75"H 6 shelves and 10 QGH700 bins

COMPLETE PACKAGES WITH BINS

400 lb. LOAD CAPACITY PER SHELF



QSBU-600 18"D x 36"W x 75"H 6 shelves and 15 QGH600 bins



QSBU-600800 18"D x 36"W x 75"H 6 shelves, 6 QGH600 bins and 6 QGH800 bins



QSBU-800 18"D x 36"W x 75"H 6 shelves and 10 QGH800 bins

QGH700 available in: Blue Ivory Red Black Gray Clear

QGH600 and QGH800 available in: Blue Red Gray Clear (One color per unit)

GIANT Stack Container Wire Shelving Systems - Complete Packages



WR5-600
18"W x 36"L x 74"H
5 shelves and 12 QGH600
17-1/2"L x 10-7/8"W x 12-1/2"H bins

COMPLETE PACKAGES WITH BINS

CLEAR VIEW
AVAILABLE on pg. 23



WR5-600800
18"W x 36"L x 74"H
5 shelves and 6 QGH600 17-1/2"L x 10-7/8"W x 12-1/2"H bins and 4 QGH800 17-1/2"L x 16-1/2"W x 12-1/2"H bins

800 lb. LOAD CAPACITY PER SHELF



WR5-800
18"W x 36"L x 74"H
5 shelves and 8 QGH800
17-1/2"L x 16-1/2"W x 12-1/2"H bins



MOBILIZE YOUR WIRE SHELVING

DB - Donut Bumper
Non-marking donut bumper used to protect walls and help cushion impact.

WR-00H (Mobile Kit)
Set of four swivel thermoplastic resin 5" x 1-1/4" casters, two with brakes. Can be used with all units shown. 1,200 lb. load capacity.



WR5-700
18"W x 42"L x 74"H
5 shelves and 8 QGH700
15-1/4"L x 19-7/8"W x 12-7/16"H bins

QGH700 available in: ● Blue ● Ivory ● Red ● Black ● Gray ● Clear

QGH600 and QGH800 available in: ● Blue ● Red ● Gray ● Clear (One color per unit)



6 SIZES AND 5 COLORS AVAILABLE



PERFORMANCE FEATURES:

- Available in 6 sizes and 5 colors (Blue, Green, Red, Yellow and Black) for inventory control and color code efficiency
- These heavy-duty containers are injection molded from high density polypropylene and are ideal for storage and transport of large and heavy parts
- Extra heavy, double wall thickness allows containers to stack securely
- 150 lb. stack capacity

MAGNUM Bins - Super Strong and Durable



150 lb. STACK CAPACITY PER BIN

Heavy-duty, extra strong injection molded, high density polypropylene bins are ideal for transportation and storage of large and heavy parts. Open hopper front allows immediate access and visibility. Ribbed reinforced walls ensure extra strength. Double wall thickness with preformed lip allows bin to interlock and provides up to 150 lb. stack capacity. Transport these bins easily with rear molded handle. Molded in label slot. Impervious to most solvents, corrosion, rust and rot resistant. Resists temperatures from -40°F to 250°F. Optional window front maximizes storage and prevents spillage. Optional dividers maximize flexibility and keeps contents organized.

Available in: ● Blue ● Green ● Red ● Yellow ● Black

MODEL NO.	OUTSIDE DIMENSIONS L" x W" x H"	INSIDE DIMENSIONS L" x W" x H"	X"	CTN QTY	CTN WGT	DIVIDERS	CTN QTY	WINDOW	CTN QTY
QMS531	19-3/4" x 12-3/8" x 5-7/8"	17" x 11" x 5"	17"	6	19 lbs	DMS531	6	WMS531	6
QMS532	19-3/4" x 12-3/8" x 7-7/8"	16-3/4" x 11" x 7-1/4"	16-3/4"	6	23 lbs	DMS532	6	WMS532	6
QMS533	19-3/4" x 12-3/8" x 11-7/8"	16-5/8" x 10-1/4" x 11-1/8"	16-5/8"	3	15 lbs	DMS533	3	WMS533	3
QMS543	19-3/4" x 18-3/8" x 11-7/8"	16-5/8" x 16-3/4" x 11"	16-5/8"	1	8 lbs	DMS543	1	WMS543	1
QMS743*	29" x 18-3/8" x 11-7/8"	25-1/2" x 16-3/4" x 11"	23"	1	10 lbs	-	-	-	-
QMS843MOB*	29" x 18-3/8" x 14-7/8"	25-1/2" x 16-3/4" x 11"	23"	1	12 lbs	-	-	-	-

*Includes heavy-duty spread bar for extra strength and support

COMFORT HANDLE
for easy gripping and handling



QMS743 and QMS843MOB
Includes heavy-duty spread bar for extra strength and support



ATTACHED PULL RING
allows dolly to be pulled with ease



Polymer Dolly

DLY-3018 is 30"L x 18"W with padded rubber trim, available in Blue. Set of four 4" x 1-1/4" non-marking swivel poly casters. Both dollies have 1,000 lb. load capacity.

MODEL NO.	DESCRIPTION	CTN WGT
DLY-3018	Dolly with Padded Rubber Trim	19 lbs
HANDLE-DLY	32" Dolly Pull Rod with Handle	2 lbs

Bins sold separately



CLEAR WINDOW FRONT
Increases bin capacity and provides a quick view of the bin contents. (Optional)



MAGNUM BIN
Shown with optional divider



LTR-1754
Clear Label Holder and Insert
Fits all Magnum bin sizes.
Package of 25.



Mobile MAGNUM Bins

- Bin comes with 4 swivel 3" polyurethane casters, all with brakes, allowing for 250 lb. mobile capacity
- Bins can stack on each other with casters in place
- QMS843MOB includes heavy-duty spread bar

MAGNUM Bin Steel Shelving Systems - Complete Packages



These ultra heavy-duty shelving systems incorporate Quantum's Giant MAGNUM Bins. Five combinations allow you a wide selection to choose from. Bins offer optional clear window fronts as well as dividers for maximum storage capacity. Shelving is tough 42" wide with a 350 lb. load capacity per shelf. Smooth powder coat finish is rust and corrosion resistant.

COMPLETE PACKAGES WITH BINS

MAGNUM

18" DEEP UNITS

18"D x 42"W x 75"H Shelving



MSU-531

10 shelves and 27 QMS531
19-3/4"L x 12-3/8"W x 5-7/8"H bins

MSU-16-MIX

7 shelves and 4 QMS543
19-3/4"L x 18-3/8"W x 11-7/8"H bins,
3 QMS533
19-3/4"L x 12-3/8"W x 11-7/8"H bins,
6 QMS532
19-3/4"L x 12-3/8"W x 7-7/8"H bins,
3 QMS531
19-3/4"L x 12-3/8"W x 5-7/8"H bins

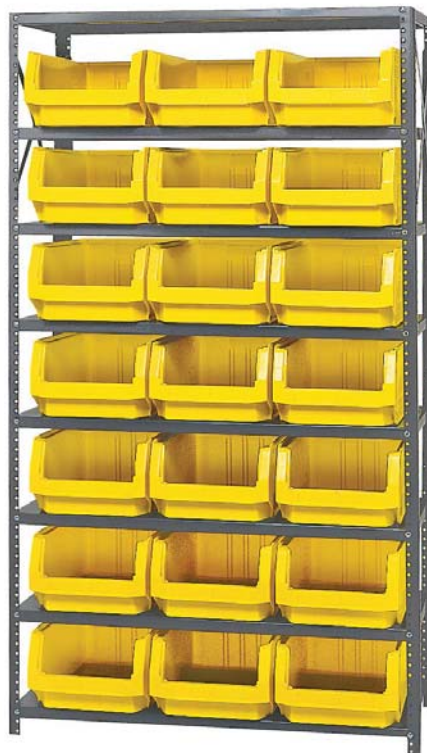

MSU-532

8 shelves and 21 QMS532
19-3/4"L x 12-3/8"W x 7-7/8"H bins



MSU-533

6 shelves and 15 QMS533
19-3/4"L x 12-3/8"W x 11-7/8"H bins



MSU-543

6 shelves and 10 QMS543
19-3/4"L x 18-3/8"W x 11-7/8"H bins

Bins available in: ● Blue ● Green ● Red ● Yellow ● Black (One color per unit)



MAGNUM Bin Wire Shelving Systems - Complete Packages



WR9-531
18"W x 42"L x 74"H
9 shelves and 24 QMS531
19-3/4"L x 12-3/8"W x 5-7/8"H bins



WR7-532
18"W x 42"L x 74"H
7 shelves and 18 QMS532
19-3/4"L x 12-3/8"W x 7-7/8"H bins



WR5-533
18"W x 42"L x 74"H
5 shelves and 12 QMS533
19-3/4"L x 12-3/8"W x 11-7/8"H bins



WR5-543
18"W x 42"L x 74"H
5 shelves and 8 QMS543
19-3/4"L x 18-3/8"W x 11-7/8"H bins

800 lb.
LOAD CAPACITY PER SHELF

MAGNUM

**COMPLETE
PACKAGES
WITH BINS**



MOBILIZE YOUR WIRE SHELVING

DB - Donut Bumper
Non-marking donut bumper used to protect walls and help cushion impact.

WR-00H (Mobile Kit)
Set of four swivel thermoplastic resin 5" x 1-1/4" casters, two with brakes. Can be used with all units shown. 1,200 lb. load capacity.



WR6-13-MIX
18"W x 42"L x 74"H
6 shelves and 4 QMS543 19-3/4"L x 18-3/8"W x 11-7/8"H bins
3 QMS533 19-3/4"L x 12-3/8"W x 11-7/8"H bins
3 QMS532 19-3/4"L x 12-3/8"W x 7-7/8"H bins
3 QMS531 19-3/4"L x 12-3/8"W x 5-7/8"H bins

Bins available in: ● Blue ● Green ● Red ● Yellow ● Black (One color per unit)



AVAILABLE on pg. 24

13 SIZES AND 8 COLORS AVAILABLE

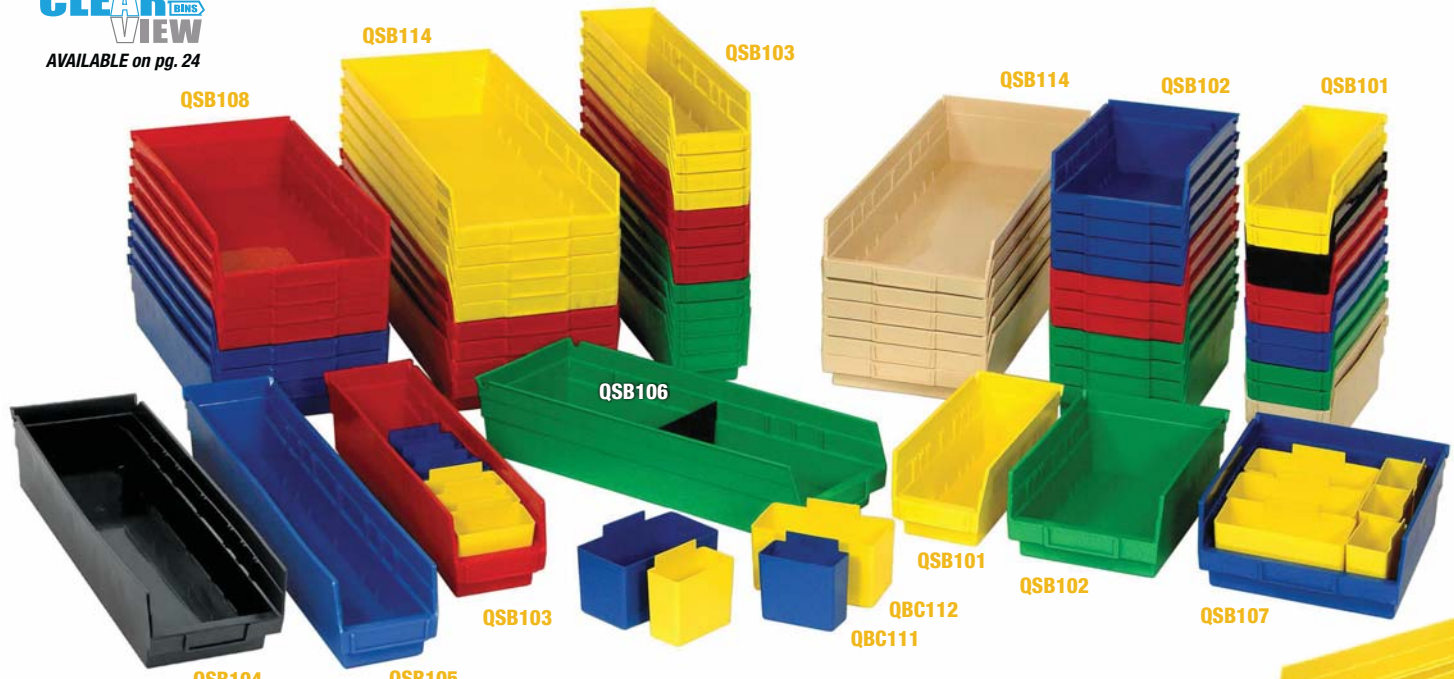

Pink color in select sizes

LOW COST, LONG LASTING, UNBREAKABLE, REUSABLE 4" HIGH BINS

10° Angle
45° Angle



LTR-0813
Clear Label Holder and Insert
Clear label holders and laser label inserts. Package of 25. Label holders fit all bins (except QSB100).

Divider Label Tab

Divider Label Tabs attach to existing dividers enabling sections of bin to be labeled. Tabs improve the visibility of bin labels and scanning of barcodes. Package of 6.



DLT-6

Extended Label Holders - Simplify Identification



Optional extended label holders are designed for larger bar code scanning or just larger labels. Label holders fit all Shelf Bins (except QSB100).

MODEL NO.	DESCRIPTION	DIMENSIONS W" x H"	CTN QTY
ELH410	10° Angle	4" x 2-1/4"	24
ELH445	45° Angle	4" x 2-1/4"	24

Economy 4" Shelf Bins



Quantum's tough, durable, high density Economy Shelf Bins are the industry standard for quality. These durable polypropylene bins feature a molded-in label holder, built-in rear hanglock which allows bins to tilt out for complete access when on shelving. A wide hopper front allows complete access to the contents of the bin. Edges are reinforced for added strength. They are designed for 12", 18" and 24" deep shelf units, racks or standard shelving. Bins are impervious to most chemicals. See pg. 24 to order Clear Bins.

Available in: ● Blue ● Green ● Ivory ● Red ● Yellow ● Black ● Clear

QSB101, QSB102, QSB103, QSB104 also available in: ● Pink

MODEL NO.	OUTSIDE DIMENSIONS L" x W" x H"	INSIDE DIMENSIONS L" x W" x H"	CTN QTY	CTN WGT	DIVIDER	CTN QTY	NO. OF BIN CUPS PER BIN
						QBC111	QBC112
QSB100	11-5/8" x 2-3/4" x 4"	10-1/4" x 1-5/8" x 4"	36	13 lbs	-	-	3
QSB101	11-5/8" x 4-1/8" x 4"	10-1/4" x 3" x 4"	36	17 lbs	DSB101	50	6
QSB102	11-5/8" x 6-5/8" x 4"	10-1/4" x 5-1/2" x 4"	30	18 lbs	DSB102	50	9
QSB107	11-5/8" x 8-3/8" x 4"	10-1/4" x 7-1/8" x 4"	20	15 lbs	DSB107	50	12
QSB109	11-5/8" x 11-1/8" x 4"	10-1/4" x 10" x 4"	8	7 lbs	DSB109	50	18
QSB103	17-7/8" x 4-1/8" x 4"	16-1/2" x 3" x 4"	20	13 lbs	DSB103	50	9
QSB104	17-7/8" x 6-5/8" x 4"	16-1/2" x 5-1/2" x 4"	20	16 lbs	DSB104	50	15
QSB108	17-7/8" x 8-3/8" x 4"	16-1/2" x 7-1/8" x 4"	10	11 lbs	DSB108	50	19
QSB110	17-7/8" x 11-1/8" x 4"	16-1/2" x 10" x 4"	8	11 lbs	DSB110	50	29
QSB105	23-5/8" x 4-1/8" x 4"	22-1/8" x 3" x 4"	16	13 lbs	DSB105	50	13
QSB106	23-5/8" x 6-5/8" x 4"	22-1/8" x 5-1/2" x 4"	8	9 lbs	DSB106	50	21
QSB114	23-5/8" x 8-3/8" x 4"	22-1/8" x 7-1/8" x 4"	6	9 lbs	DSB114	50	24
QSB116	23-5/8" x 11-1/8" x 4"	22-1/8" x 10" x 4"	6	10 lbs	DSB116	50	35

Dividers and Bin Cups



Optional dividers fit snugly, horizontally across bins and are uniquely designed to allow for easy part labeling via individual label slots. All bins can accommodate up to 7 dividers.

Bin cups have a raised, slotted label holder for easy parts identification. The entire bin cup may be removed for easy part retrieval. Available in 2 sizes and 2 colors.

Available in: ● Blue ● Yellow

MODEL NO.	OUTSIDE DIMENSIONS L" x W" x H"	CTN QTY	CTN WGT
QBC111	3-1/4" x 1-3/4" x 3"	48	4 lbs
QBC112	5-1/8" x 2-3/4" x 3"	48	7 lbs



Economy 4" Shelf Bin Steel Shelving Systems - Complete Packages

Economical small parts storage steel systems keep parts easily accessible. Open hopper front bins with label area provide fast access to stored items. This all-in-one unit is easy to clean and will not rust or corrode. Heavy-duty, high grade shelving offers a 400 lb. capacity per shelf. 36" wide shelving units have a smooth powder coat finish. Bins are available in 7 colors.

Bins available in: ● Blue ● Green ● Ivory ● Red ● Yellow
● Black ● Clear (One color per unit)

MODEL NO.	NO. OF BINS	BIN DIMENSIONS L" x W" x H"	SHIP WGT
12"D x 36"W x 75"H - 13 Shelf Systems			
1275-100	144 QSB100	11-5/8" x 2-3/4" x 4"	139 lbs
1275-101	96 QSB101	11-5/8" x 4-1/8" x 4"	117 lbs
1275-102	60 QSB102	11-5/8" x 6-5/8" x 4"	115 lbs
1275-107	48 QSB107	11-5/8" x 8-3/8" x 4"	120 lbs
1275-109	36 QSB109	11-5/8" x 11-1/8" x 4"	119 lbs
1275-000	12" Deep Shelving Unit Only - No Bins		87 lbs
12"D x 36"W x 39"H - 7 Shelf Systems			
1239-100	72 QSB100	11-5/8" x 2-3/4" x 4"	75 lbs
1239-101	48 QSB101	11-5/8" x 4-1/8" x 4"	67 lbs
1239-102	30 QSB102	11-5/8" x 6-5/8" x 4"	63 lbs
1239-107	24 QSB107	11-5/8" x 8-3/8" x 4"	64 lbs
1239-109	18 QSB109	11-5/8" x 11-1/8" x 4"	65 lbs
1239-000	12" Deep Shelving Unit Only - No Bins		49 lbs
18"D x 36"W x 75"H - 13 Shelf Systems			
1875-103	96 QSB103	17-7/8" x 4-1/8" x 4"	161 lbs
1875-104	60 QSB104	17-7/8" x 6-5/8" x 4"	155 lbs
1875-108	48 QSB108	17-7/8" x 8-3/8" x 4"	161 lbs
1875-110	36 QSB110	17-7/8" x 11-1/8" x 4"	158 lbs
1875-000	18" Deep Shelving Unit Only - No Bins		113 lbs
18"D x 36"W x 39"H - 7 Shelf Systems			
1839-103	48 QSB103	17-7/8" x 4-1/8" x 4"	87 lbs
1839-104	30 QSB104	17-7/8" x 6-5/8" x 4"	84 lbs
1839-108	24 QSB108	17-7/8" x 8-3/8" x 4"	87 lbs
1839-110	18 QSB110	17-7/8" x 11-1/8" x 4"	86 lbs
1839-000	18" Deep Shelving Unit Only - No Bins		63 lbs



REAR "V" LOCK
enables bins to be hung from shelf above when in use

**ECONOMICAL
SMALL PARTS
STORAGE
SYSTEMS
KEEP PARTS
EASILY
ACCESSIBLE**

1275-102

COMPLETE PACKAGES WITH BINS



1839-104



AVAILABLE on pg. 25

**COLOR CODE
PRODUCTS
TO SIMPLIFY
ORDER
PICKING AND
INVENTORY
CONTROL**





Economy 4" Shelf Bin Sloped Shelving Systems - Complete Packages



Pick Racks provide a convenient high density, easy access, sloped shelving system, available as bench units, single, and double sided free standing and mobile units. Units come complete with Economical 4" Shelf Bins. Sloped shelving unit keeps small and medium sized parts easily accessible. Open hopper front bins with label area, provide fast access to stored items. This all-in-one unit is easy to clean and will not rust or corrode. See chart for configurations. One bin color per unit.



QPRHA-102
Bench Pick Rack
250 lb. capacity.

Bins available in: ● Blue ● Green ● Ivory ● Red ● Yellow ● Black ● Clear

MODEL NO.	NO. OF BINS	BIN DIMENSIONS L" x W" x H"	SHIP WGT
12-1/2"L x 36"W x 23"H - 3 Shelf Bench Rack Systems			
QPRHA-100	36 QSB100	11-5/8" x 2-3/4" x 4"	41 lbs
QPRHA-101	24 QSB101	11-5/8" x 4-1/8" x 4"	38 lbs
QPRHA-102	15 QSB102	11-5/8" x 6-5/8" x 4"	36 lbs
QPRHA-107	12 QSB107	11-5/8" x 8-3/8" x 4"	36 lbs
QPRHA-109	9 QSB109	11-5/8" x 11-1/8" x 4"	37 lbs
QPRHA-000	12" Deep Bench Rack Only - No Bins		26 lbs
12"L x 36"W x 60"H - Single Sided 8 Shelf Rack Systems			
QPRS-100	96 QSB100	11-5/8" x 2-3/4" x 4"	99 lbs
QPRS-101	64 QSB101	11-5/8" x 4-1/8" x 4"	85 lbs
QPRS-102	40 QSB102	11-5/8" x 6-5/8" x 4"	80 lbs
QPRS-107	32 QSB107	11-5/8" x 8-3/8" x 4"	81 lbs
QPRS-109	24 QSB109	11-5/8" x 11-1/8" x 4"	83 lbs
QPRS-000	12" Deep Single Sided Rack Only - No Bins		53 lbs
18"L x 36"W x 60"H - Single Sided 8 Shelf Rack Systems			
QPRS-103	64 QSB103	17-7/8" x 4-1/8" x 4"	124 lbs
QPRS-104	40 QSB104	17-7/8" x 6-5/8" x 4"	110 lbs
QPRS-108	32 QSB108	17-7/8" x 8-3/8" x 4"	115 lbs
QPRS-110	24 QSB110	17-7/8" x 11-1/8" x 4"	111 lbs
QPRS18-000	18" Deep Single Sided Rack Only - No Bins		78 lbs
24"L x 36"W x 60"H - Double Sided 16 Shelf Rack Systems			
QPRD-100	192 QSB100	11-5/8" x 2-3/4" x 4"	195 lbs
QPRD-101	128 QSB101	11-5/8" x 4-1/8" x 4"	169 lbs
QPRD-102	80 QSB102	11-5/8" x 6-5/8" x 4"	158 lbs
QPRD-107	64 QSB107	11-5/8" x 8-3/8" x 4"	160 lbs
QPRD-109	48 QSB109	11-5/8" x 11-1/8" x 4"	163 lbs
QPRD-000	24" (12" on each side) Deep Double Sided Rack Only - No Bins		106 lbs
QDU-00*	Mobile Kit - Mobilizes All Double Sided Systems		25 lbs
36"L x 36"W x 60"H - Double Sided 16 Shelf Rack Systems			
QPRD-103	128 QSB103	17-7/8" x 4-1/8" x 4"	241 lbs
QPRD-104	80 QSB104	17-7/8" x 6-5/8" x 4"	220 lbs
QPRD-108	64 QSB108	17-7/8" x 8-3/8" x 4"	226 lbs
QPRD-110	48 QSB110	17-7/8" x 11-1/8" x 4"	222 lbs
QPRD18-000	36" (18" on each side) Deep Double Sided Rack Only - No Bins		156 lbs
QDU-18*	Mobile Kit - Mobilizes All Double Sided Systems		35 lbs

*1,200 lb. load capacity. 2 rigid, 2 swivel with brake hard rubber casters.

SLOPED SHELVES, EASY ACCESS, MOST POPULAR AND VERSATILE STORAGE SYSTEMS SOLD



QPRD-102 + QDU-00
Mobile, Double Sided Pick Rack
1,200 lb. load capacity. 2 rigid, 2 swivel with brake hard rubber casters.



QPRD-107
Double Sided Pick Rack
800 lb. capacity.



QPRS-101
Single Sided Pick Rack
400 lb. capacity.



WR12-101

COMPLETE PACKAGES WITH BINS



AVAILABLE on pg. 24

800 lb. LOAD CAPACITY PER SHELF



MOBILIZE YOUR WIRE SHELVING

DB - Donut Bumper

Non-marking donut bumper used to protect walls and help cushion impact.

WR-00H (Mobile Kit)*

Set of four swivel thermoplastic resin 5" x 1-1/4" casters, two with brakes. 1,200 lb. load capacity.

*Mobile kits recommended only for shelves 18" and deeper.



WR12-102



WR12-107

Economy 4" Shelf Bin Wire Shelving Systems - Complete Packages

Bins available in: Blue Green Ivory Red Yellow Black Clear (One color per unit)

MODEL NO.	NO. OF BINS	BIN DIMENSIONS L" x W" x H"	SHIP WGT
12"W x 36"L x 74"H - 12 Shelf Systems			
WR12-101	88 QSB101	11-5/8" x 4-1/8" x 4"	120 lbs
WR12-102	55 QSB102	11-5/8" x 6-5/8" x 4"	116 lbs
WR12-107	44 QSB107	11-5/8" x 8-3/8" x 4"	117 lbs
WR12-109	33 QSB109	11-5/8" x 11-1/8" x 4"	119 lbs
18"W x 36"L x 74"H - 12 Shelf Systems			
WR12-103	88 QSB103	17-7/8" x 4-1/8" x 4"	176 lbs
WR12-104	55 QSB104	17-7/8" x 6-5/8" x 4"	165 lbs
WR12-108	44 QSB108	17-7/8" x 8-3/8" x 4"	170 lbs
WR12-110	33 QSB110	17-7/8" x 11-1/8" x 4"	168 lbs
24"W x 36"L x 74"H - 12 Shelf Systems			
WR12-105	88 QSB105	23-5/8" x 4-1/8" x 4"	228 lbs
WR12-106	55 QSB106	23-5/8" x 6-5/8" x 4"	218 lbs
WR12-114	44 QSB114	23-5/8" x 8-3/8" x 4"	222 lbs
WR12-116	33 QSB116	23-5/8" x 11-1/8" x 4"	206 lbs

Economy 4" Complete Bin Center

Complete bin systems are available with 4 different size bin options on a 12"W x 36"L x 36"H unit. This all-purpose bin center is an economical high density storage system that provides easy visibility to stored contents.

- Easy boltless assembly
- Wire allows air to circulate as well as provides ideal product visibility
- Durable chrome finish ensures years of heavy-duty dependability and service

Bins available in: Blue Green Ivory Red Yellow Black Clear (One color per unit)

MODEL NO.	NO. OF BINS	BIN DIMENSIONS L" x W" x H"	SHIP WGT
12"W x 36"L x 36"H - 6 Shelf Systems			
WR6-36-1236-101	40 QSB101	11-5/8" x 4-1/8" x 4"	63 lbs
WR6-36-1236-102	25 QSB102	11-5/8" x 6-5/8" x 4"	50 lbs
WR6-36-1236-107	20 QSB107	11-5/8" x 8-3/8" x 4"	62 lbs
WR6-36-1236-109	15 QSB109	11-5/8" x 11-1/8" x 4"	64 lbs



WR6-36-1236-102

High Density Wire Shelving Systems



- Wire Storage Systems with bins available in 48", 60" and 72" lengths
- All units in chart below utilize 74" posts and include 12 shelves
- Non-marring thermoplastic resin caster kit **WR-00H** (sold separately)



WR74-2448-66106

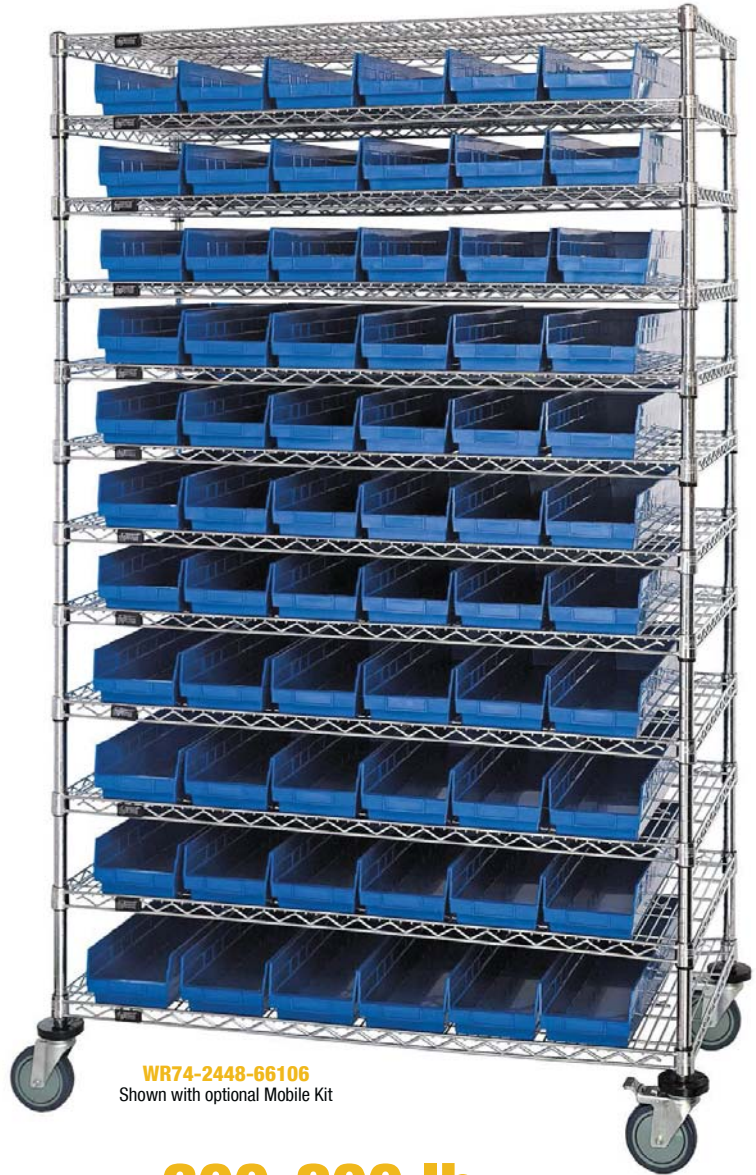

WR74-2448-66106
 Shown with optional Mobile Kit

600-800 lb.
LOAD CAPACITY PER SHELF



MOBILIZE YOUR WIRE SHELVING

DB - Donut Bumper
 Non-marking donut bumper used to protect walls and help cushion impact.

WR-00H (Mobile Kit)*
 Set of four swivel thermoplastic resin 5" x 1-1/4" casters, two with brakes. 1,200 lb. load capacity.
 *Mobile kits recommended only for shelves 18" and deeper.

Bins available in: ● Blue ● Green ● Ivory ● Red ● Yellow ● Black ● Clear (One color per unit)

HIGH DENSITY WIRE SYSTEMS									
48"L SYSTEMS			60"L SYSTEMS			72"L SYSTEMS			
BIN DIMENSIONS L" x W" x H"	MODEL NO.	NO. OF BINS	SHIP WGT	MODEL NO.	NO. OF BINS	SHIP WGT	MODEL NO.	NO. OF BINS	SHIP WGT
12"W x 48"L - Systems									
11-5/8" x 4-1/8" x 4"	WR74-1248-110101	110 QSB101	152 lbs	WR74-1260-143101	143 QSB101	208 lbs	WR74-1272-176101	176 QSB101	248 lbs
11-5/8" x 4-1/8" x 4"	WR74-1248-101102	55 QSB101 36 QSB102	148 lbs	WR74-1260-101102	78 QSB101 40 QSB102	213 lbs	WR74-1272-101102	80 QSB101 60 QSB102	240 lbs
11-5/8" x 6-5/8" x 4"	WR74-1248-66102	66 QSB102	140 lbs	WR74-1260-88102	88 QSB102	193 lbs	WR74-1272-110102	110 QSB102	230 lbs
18"W x 48"L - Systems									
17-7/8" x 4-1/8" x 4"	WR74-1848-110103	110 QSB103	168 lbs	WR74-1860-143103	143 QSB103	224 lbs	WR74-1872-176103	176 QSB103	264 lbs
17-7/8" x 4-1/8" x 4"	WR74-1848-103104	55 QSB103 36 QSB104	164 lbs	WR74-1860-103104	78 QSB103 40 QSB104	229 lbs	WR74-1872-103104	80 QSB103 60 QSB104	256 lbs
17-7/8" x 6-5/8" x 4"	WR74-1848-66104	66 QSB104	156 lbs	WR74-1860-88104	88 QSB104	209 lbs	WR74-1872-110104	110 QSB104	246 lbs
24"W x 48"L - Systems									
23-5/8" x 4-1/8" x 4"	WR74-2448-110105	110 QSB105	180 lbs	WR74-2460-143105	143 QSB105	256 lbs	WR74-2472-176105	176 QSB105	312 lbs
23-5/8" x 4-1/8" x 4"	WR74-2448-105106	55 QSB105 36 QSB106	176 lbs	WR74-2460-105106	78 QSB105 40 QSB106	261 lbs	WR74-2472-105106	80 QSB105 60 QSB106	304 lbs
23-5/8" x 6-5/8" x 4"	WR74-2448-66106	66 QSB106	168 lbs	WR74-2460-88106	88 QSB106	241 lbs	WR74-2472-110106	110 QSB106	294 lbs

48"L - 800 lb. Capacity/Shelf

60"L - 600 lb. Capacity/Shelf

72"L - 600 lb. Capacity/Shelf



AVAILABLE on pg. 26

12 SIZES AND 4 COLORS AVAILABLE

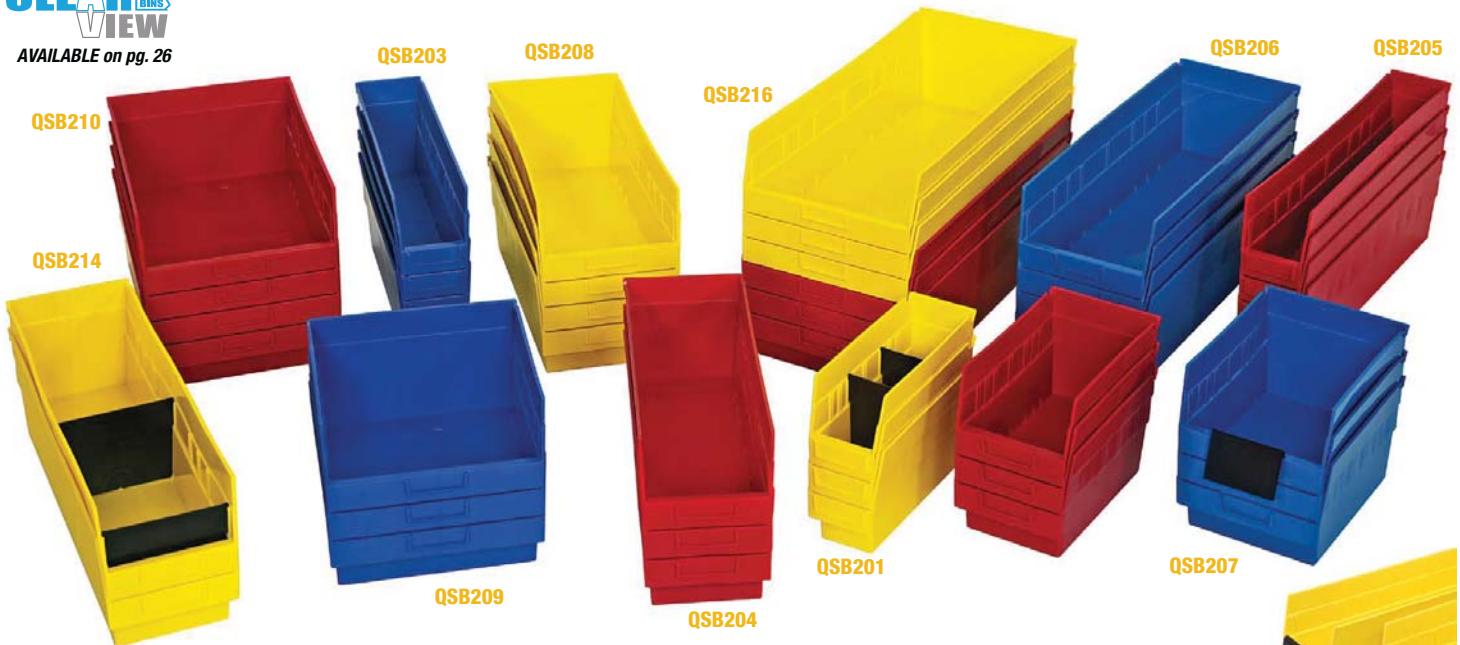

LOW COST, LONG LASTING, UNBREAKABLE, REUSABLE, 6" HIGH SHELF BINS

10° Angle
45° Angle



with 68% more storage capacity over standard 4" shelf bins, Quantum's **STORE-MORE 6"** Shelf Bins are an industry first and now an industry standard

Divider Label Tab

Divider Label Tabs attach to existing dividers enabling sections of bin to be labeled. Tabs improve the visibility of bin labels and scanning of barcodes. Package of 6.



DLT-6

LTR-0813

Clear Label Holder and Insert
Clear label holders and laser label inserts. Clear label holders fit all 6" Shelf Bins. Package of 25.



Extended Label Holders - Simplify Identification

Optional extended label holders are designed for larger bar code scanning or just larger labels. Label holders fit all 6" Shelf Bins.

MODEL NO.	DESCRIPTION	DIMENSIONS W" x H"	CTN QTY
ELH410	10° Angle	4" x 2-1/4"	24
ELH445	45° Angle	4" x 2-1/4"	24

STORE-MORE 6" Shelf Bins



Maximize your storage space with durable, high density polypropylene bins. Quantum's STORE-MORE 6" Shelf Bins are the industry standard for quality. These bins feature a molded-in label holder, built-in rear hang-lock which allows bins to tilt out for complete access when on shelving. A wide hopper front allows complete access to the contents of the bin. Edges are reinforced for added strength. They are designed for 12", 18" and 24" deep shelf units, racks or standard shelving. Optional dividers are a perfect accessory to subdivide and keep parts separated as needed. Bins are waterproof and corrosion-free. See *pg. 26* to order Clear Bins.

Available in: ● Blue ● Red ● Yellow ● Clear

MODEL NO.	OUTSIDE DIMENSIONS L" x W" x H"	INSIDE DIMENSIONS L" x W" x H"	CTN QTY	CTN WGT	DIVIDER	CTN QTY	NO. OF BIN CUPS PER BIN
							QBC111 QBC112
QSB201	11-5/8" x 4-1/8" x 6"	10-1/6" x 3" x 6"	36	19 lbs	DSB201	50	6 2
QSB202	11-5/8" x 6-5/8" x 6"	10-1/6" x 5-1/2" x 6"	30	20 lbs	DSB202	50	9 4
QSB207	11-5/8" x 8-3/8" x 6"	10-1/6" x 7-1/8" x 6"	20	17 lbs	DSB207	50	12 4
QSB209	11-5/8" x 11-1/8" x 6"	10-1/6" x 10" x 6"	8	9 lbs	DSB209	50	18 6
QSB203	17-7/8" x 4-1/8" x 6"	16-1/2" x 3" x 6"	20	15 lbs	DSB203	50	9 3
QSB204	17-7/8" x 6-5/8" x 6"	16-1/2" x 5-1/2" x 6"	20	18 lbs	DSB204	50	15 6
QSB208	17-7/8" x 8-3/8" x 6"	16-1/2" x 7-1/8" x 6"	10	13 lbs	DSB208	50	19 6
QSB210	17-7/8" x 11-1/8" x 6"	16-1/2" x 10" x 6"	8	13 lbs	DSB210	50	29 8
QSB205	23-5/8" x 4-1/8" x 6"	22-1/8" x 3" x 6"	16	15 lbs	DSB205	50	13 4
QSB206	23-5/8" x 6-5/8" x 6"	22-1/8" x 5-1/2" x 6"	8	11 lbs	DSB206	50	21 8
QSB214	23-5/8" x 8-3/8" x 6"	22-1/8" x 7-1/8" x 6"	6	11 lbs	DSB214	50	24 8
QSB216	23-5/8" x 11-1/8" x 6"	22-1/8" x 10" x 6"	6	12 lbs	DSB216	50	35 16



Dividers and Bin Cups

Optional black dividers fit snugly, horizontally across bins to create compartments. Each bin accepts up to 8 dividers. Bins have a slot at the very front allowing the open hopper to be closed off creating even more storage.

Bin cups have a raised, slotted label holder for easy parts identification. The entire bin cup may be removed for easy part retrieval. Available in 2 sizes and 2 colors.

Available in: ● Blue ● Yellow

MODEL NO.	OUTSIDE DIMENSIONS L" x W" x H"	CTN QTY	CTN WGT
QBC111	3-1/4" x 1-3/4" x 3"	48	4 lbs
QBC112	5-1/8" x 2-3/4" x 3"	48	7 lbs



STORE-MORE 6" Shelf Bin Steel Shelving Systems - Complete Packages

CLEARVIEW
AVAILABLE on pg. 27

- Economical small parts storage systems keep parts easily accessible
- Open hopper front bins with label area, provide fast access to stored items
- This all-in-one unit is easy to clean and is rust and corrosion resistant
- Heavy-duty, high grade shelving offers a 400 lb. capacity per shelf
- 36" wide shelving has a smooth powder coat finish

Bins available in: ● Blue ● Red ● Yellow ● Clear (One color per unit)

MODEL NO.	NO. OF BINS	BIN DIMENSIONS L" x W" x H"	SHIP WGT
12"D x 36"W x 75"H - 10 Shelf Systems			
1275-201	72 QSB201	11-5/8" x 4-1/8" x 6"	111 lbs
1275-202	45 QSB202	11-5/8" x 6-5/8" x 6"	103 lbs
1275-207	36 QSB207	11-5/8" x 8-3/8" x 6"	100 lbs
1275-209	27 QSB209	11-5/8" x 11-1/8" x 6"	98 lbs
12"D x 36"W x 39"H - 5 Shelf Systems			
1239-201	32 QSB201	11-5/8" x 4-1/8" x 6"	56 lbs
1239-202	20 QSB202	11-5/8" x 6-5/8" x 6"	52 lbs
1239-207	16 QSB207	11-5/8" x 8-3/8" x 6"	51 lbs
1239-209	12 QSB209	11-5/8" x 11-1/8" x 6"	50 lbs
18"D x 36"W x 75"H - 10 Shelf Systems			
1875-203	72 QSB203	17-7/8" x 4-1/8" x 6"	156 lbs
1875-204	45 QSB204	17-7/8" x 6-5/8" x 6"	141 lbs
1875-208	36 QSB208	17-7/8" x 8-3/8" x 6"	142 lbs
1875-210	27 QSB210	17-7/8" x 11-1/8" x 6"	139 lbs
18"D x 36"W x 39"H - 5 Shelf Systems			
1839-203	32 QSB203	17-7/8" x 4-1/8" x 6"	77 lbs
1839-204	20 QSB204	17-7/8" x 6-5/8" x 6"	70 lbs
1839-208	16 QSB208	17-7/8" x 8-3/8" x 6"	71 lbs
1839-210	12 QSB210	17-7/8" x 11-1/8" x 6"	69 lbs



1839-208

COMPLETE PACKAGES WITH BINS



1275-201



1275-202



1875-210



AVAILABLE on pg. 27

Bins available in: Blue Red Yellow Clear (One color per unit)

MODEL NO.	NO. OF BINS	BIN DIMENSIONS L" x W" x H"	SHIP WGT
12"L x 36"W x 26-1/2"H - 3 Shelf Bench Rack Systems			
QPRHA-201	24 QSB201	11-5/8" x 4-1/8" x 6"	40 lbs
QPRHA-202	15 QSB202	11-5/8" x 6-5/8" x 6"	37 lbs
QPRHA-207	12 QSB207	11-5/8" x 8-3/8" x 6"	36 lbs
QPRHA-209	9 QSB209	11-5/8" x 11-1/8" x 6"	35 lbs
QPRHA-6	12" Deep Bench Rack Only - No Bins		28 lbs
12"L x 36"W x 63-1/2"H - Single Sided 8 Shelf Rack Systems			
QPRS-201	64 QSB201	11-5/8" x 4-1/8" x 6"	89 lbs
QPRS-202	40 QSB202	11-5/8" x 6-5/8" x 6"	81 lbs
QPRS-207	32 QSB207	11-5/8" x 8-3/8" x 6"	79 lbs
QPRS-209	24 QSB209	11-5/8" x 11-1/8" x 6"	77 lbs
QPRS-6	12" Deep Single Sided Rack Only - No Bins		55 lbs
18"L x 36"W x 63-1/2"H - Single Sided 8 Shelf Rack Systems			
QPRS-203	64 QSB203	17-7/8" x 4-1/8" x 6"	126 lbs
QPRS-204	40 QSB204	17-7/8" x 6-5/8" x 6"	114 lbs
QPRS-208	32 QSB208	17-7/8" x 8-3/8" x 6"	120 lbs
QPRS-210	24 QSB210	17-7/8" x 11-1/8" x 6"	117 lbs
QPRS18-6	18" Deep Single Sided Rack Only - No Bins		78 lbs
24"L x 36"W x 63-1/2"H - Double Sided 16 Shelf Rack Systems			
QPRD-201	128 QSB201	11-5/8" x 4-1/8" x 6"	178 lbs
QPRD-202	80 QSB202	11-5/8" x 6-5/8" x 6"	162 lbs
QPRD-207	64 QSB207	11-5/8" x 8-3/8" x 6"	158 lbs
QPRD-209	48 QSB209	11-5/8" x 11-1/8" x 6"	154 lbs
QPRD-6	24" (12" on each side) Deep Double Sided Rack Only - No Bins		110 lbs
QDU-00*	Mobile Kit - Mobilizes All 24" Deep Double Sided Units		25 lbs
36"L x 36"W x 63-1/2"H - Double Sided 16 Shelf Rack Systems			
QPRD-203	128 QSB203	17-7/8" x 4-1/8" x 6"	252 lbs
QPRD-204	80 QSB204	17-7/8" x 6-5/8" x 6"	228 lbs
QPRD-208	64 QSB208	17-7/8" x 8-3/8" x 6"	239 lbs
QPRD-210	48 QSB210	17-7/8" x 11-1/8" x 6"	234 lbs
QPRD18-6	36" (18" on each side) Double Sided Rack Only - No Bins		156 lbs
QDU-18*	Mobile Kit - Mobilizes All 36" Deep Double Sided Units		35 lbs

*1,200 lb. load capacity. 2 rigid, 2 swivel with brake hard rubber casters.

STORE-MORE 6" Shelf Bin Sloped Shelving Systems - Complete Packages

Pick Racks provide a convenient high density, easy access, sloped shelving system, available as bench units, single, and double sided free standing and mobile units. Units come complete with STORE-MORE 6" Shelf Bins. Sloped shelving unit keeps small and medium sized parts easily accessible. Open hopper front bins with label area, provide fast access to stored items. This all-in-one unit is easy to clean and is rust and corrosion resistant. See chart for configurations.



QPRHA-209 Bench Pick Rack 250 lb. capacity.

SLOPED SHELVES, EASY ACCESS, MOST POPULAR AND VERSATILE STORAGE SYSTEMS SOLD



QPRD-202 + QDU-00 Mobile, Double Sided Pick Rack 1,200 lb. load capacity. 2 rigid, 2 swivel with brake hard rubber casters.



QPRD-207 Double Sided Pick Rack 800 lb. capacity.



QPRS-201 Single Sided Pick Rack 400 lb. capacity.



STORE-MORE 6" Shelf Bin Wire Shelving Systems - Complete Packages

- Easy boltless assembly
- Wire allows air to circulate as well as provides ideal product visibility
- Durable chrome finish ensures years of heavy-duty dependability and service
- All welded shelf construction is supported with super strong wire trusses to provide 800 lb. capacity per shelf

Bins available in: ● Blue ● Red ● Yellow ● Clear *(One color per unit)*

MODEL NO.	NO. OF BINS	BIN DIMENSIONS L" x W" x H"	SHIP WGT
12"W x 36"L x 74"H - 9 Shelf Systems			
WR9-201	64 QSB201	11-5/8" x 4-1/8" x 6"	108 lbs
WR9-202	40 QSB202	11-5/8" x 6-5/8" x 6"	100 lbs
WR9-207	32 QSB207	11-5/8" x 8-3/8" x 6"	98 lbs
WR9-209	24 QSB209	11-5/8" x 11-1/8" x 6"	96 lbs
18"W x 36"L x 74"H - 9 Shelf Systems			
WR9-203	64 QSB203	17-7/8" x 4-1/8" x 6"	156 lbs
WR9-204	40 QSB204	17-7/8" x 6-5/8" x 6"	142 lbs
WR9-208	32 QSB208	17-7/8" x 8-3/8" x 6"	143 lbs
WR9-210	24 QSB210	17-7/8" x 11-1/8" x 6"	140 lbs
24"W x 36"L x 74"H - 9 Shelf Systems			
WR9-205	64 QSB205	23-5/8" x 4-1/8" x 6"	182 lbs
WR9-206	40 QSB206	23-5/8" x 6-5/8" x 6"	171 lbs
WR9-214	32 QSB214	23-5/8" x 8-3/8" x 6"	165 lbs
WR9-216	24 QSB216	23-5/8" x 11-1/8" x 6"	154 lbs

COMPLETE PACKAGES WITH BINS



AVAILABLE on pg. 26

800 lb. LOAD CAPACITY PER SHELF



MOBILIZE YOUR WIRE SHELVING

DB - Donut Bumper
Non-marking donut bumper used to protect walls and help cushion impact.

WR-00H (Mobile Kit)*
Set of four swivel thermoplastic resin 5" x 1-1/4" casters, two with brakes. 1,200 lb. load capacity.
**Mobile kits recommended only for shelves 18" and deeper.*



WR9-202

STORE-MORE 6" Complete Bin Center

Complete bin systems are available with 4 different size bin options on a 12"W x 36"L x 39"H unit. This all-purpose bin center is an economical high density storage system that provides easy visibility to stored contents.

Bins available in: ● Blue ● Red ● Yellow ● Clear *(One color per unit)*

MODEL NO.	NO. OF BINS	BIN DIMENSIONS L" x W" x H"	SHIP WGT
12"W x 36"L x 36"H - 5 Shelf Systems			
WR5-39-1236-201	32 QSB201	11-5/8" x 4-3/8" x 6"	61 lbs
WR5-39-1236-202	20 QSB202	11-5/8" x 6-5/8" x 6"	57 lbs
WR5-39-1236-207	16 QSB207	11-5/8" x 8-3/8" x 6"	56 lbs
WR5-39-1236-209	12 QSB209	11-5/8" x 11-1/8" x 6"	55 lbs



WR5-39-1236-201



WR9-207



WR9-209



12 SIZES AND 4 COLORS AVAILABLE



QSB809

QSB807

QSB802

QSB801

LOW COST, LONG LASTING, UNBREAKABLE, REUSABLE, 8" HIGH BINS



LTR-1253
Clear Label Holder and Insert
Clear label holders fit all 8" Shelf Bins.
Package of 25.



DLT-6

Divider Label Tab

Divider Label Tabs attach to existing dividers enabling sections of bin to be labeled. Tabs improve the visibility of bin labels and scanning of barcodes. Package of 6.

STORE-MAX 8" Shelf Bins



Our 8" high bins offer 95% more storage capacity when compared to the standard 4" high bins and 65% more than the 6" high bins. The new STORE-MAX 8" Bins will truly maximize and organize your space. Manufactured from high density polypropylene, STORE-MAX 8" Shelf Bins are the industry standard for quality. These bins feature a molded-in label holder, built-in rear hang-lock which allows bins to tilt out for complete access when on shelving. A wide hopper front allows complete access to the contents of the bin. Edges are reinforced for added strength. They are designed for 12", 18" and 24" deep shelf units, racks, or standard shelving. Optional dividers are a perfect accessory to subdivide and keep parts separated as needed. See **pg. 23** to order Clear Bins.



Dividers and Bin Cups

Optional black dividers fit snugly, horizontally across bins to create compartments. Each bin accepts up to 7 dividers.

Bin cups have a raised, slotted label holder for easy parts identification. The entire bin cup may be removed for easy part retrieval. Available in 2 sizes and 2 colors.

Available in: ● Blue ● Yellow

MODEL NO.	OUTSIDE DIMENSIONS L" x W" x H"	CTN QTY	CTN WGT
QBC111	3-1/4" x 1-3/4" x 3"	48	4 lbs
QBC112	5-1/8" x 2-3/4" x 3"	48	7 lbs

Available in: ● Blue ● Red ● Yellow ● Clear

MODEL NO.	OUTSIDE DIMENSIONS L" x W" x H"	INSIDE DIMENSIONS L" x W" x H"	CTN QTY	CTN WGT	DIVIDER	CTN QTY	NO. OF BIN CUPS PER BIN
							QBC111 QBC112
QSB801	11-5/8" x 4-1/8" x 8"	10-1/6" x 3" x 8"	36	27 lbs	DSB801	50	6 2
QSB802	11-5/8" x 6-5/8" x 8"	10-1/6" x 5-1/2" x 8"	30	26 lbs	DSB802	50	9 4
QSB807	11-5/8" x 8-3/8" x 8"	10-1/6" x 7-1/8" x 8"	20	21 lbs	DSB807	50	12 4
QSB809	11-5/8" x 11-1/8" x 8"	10-1/6" x 10" x 8"	8	11 lbs	DSB809	50	18 6
QSB803	17-7/8" x 4-1/8" x 8"	16-1/2" x 3" x 8"	20	22 lbs	DSB803	50	9 3
QSB804	17-7/8" x 6-5/8" x 8"	16-1/2" x 5-1/2" x 8"	20	26 lbs	DSB804	50	15 6
QSB808	17-7/8" x 8-3/8" x 8"	16-1/2" x 7-1/8" x 8"	10	15 lbs	DSB808	50	19 6
QSB810	17-7/8" x 11-1/8" x 8"	16-1/2" x 10" x 8"	8	17 lbs	DSB810	50	29 8
QSB805	23-5/8" x 4-1/8" x 8"	22-1/8" x 3" x 8"	16	24 lbs	DSB805	50	13 4
QSB806	23-5/8" x 6-5/8" x 8"	22-1/8" x 5-1/2" x 8"	8	13 lbs	DSB806	50	21 8
QSB814	23-5/8" x 8-3/8" x 8"	22-1/8" x 7-1/8" x 8"	6	12 lbs	DSB814	50	24 8
QSB816	23-5/8" x 11-1/8" x 8"	22-1/8" x 10" x 8"	6	14 lbs	DSB816	50	35 16



STORE-MAX 8" Shelf Bin Steel Shelving Systems - Complete Packages

- Economical small parts storage systems keep parts easily accessible
- Open hopper front bins with label area, provide fast access to stored items
- This all-in-one unit is easy to clean and is rust and corrosion resistant
- Heavy-duty, high grade shelving offers a 400 lb. capacity per shelf
- 36" wide shelving has a smooth powder coat finish

COMPLETE PACKAGES WITH BINS

Bins available in: ● Blue ● Red ● Yellow ● Clear (One color per unit)

MODEL NO.	NO. OF BINS	BIN DIMENSIONS L" x W" x H"	SHIP WGT
12"D x 36"W x 75"H - 8 Shelf Systems			
1275-SB801	56 QSB801	11-5/8" x 4-3/8" x 8"	111 lbs
1275-SB802	35 QSB802	11-5/8" x 6-5/8" x 8"	103 lbs
1275-SB807	28 QSB807	11-5/8" x 8-3/8" x 8"	100 lbs
1275-SB809	21 QSB809	11-5/8" x 11-1/8" x 8"	98 lbs
12"D x 36"W x 39"H - 4 Shelf Systems			
1239-SB801	24 QSB801	11-5/8" x 4-3/8" x 8"	56 lbs
1239-SB802	15 QSB802	11-5/8" x 6-5/8" x 8"	52 lbs
1239-SB807	12 QSB807	11-5/8" x 8-3/8" x 8"	51 lbs
1239-SB809	9 QSB809	11-5/8" x 11-1/8" x 8"	50 lbs
18"D x 36"W x 75"H - 8 Shelf Systems			
1875-SB803	56 QSB803	17-7/8" x 4-3/8" x 8"	156 lbs
1875-SB804	35 QSB804	17-7/8" x 6-5/8" x 8"	141 lbs
1875-SB808	28 QSB808	17-7/8" x 8-3/8" x 8"	142 lbs
1875-SB810	21 QSB810	17-7/8" x 11-1/8" x 8"	139 lbs
18"D x 36"W x 39"H - 4 Shelf Systems			
1839-SB803	24 QSB803	17-7/8" x 4-3/8" x 8"	77 lbs
1839-SB804	15 QSB804	17-7/8" x 6-5/8" x 8"	70 lbs
1839-SB808	12 QSB808	17-7/8" x 8-3/8" x 8"	71 lbs
1839-SB810	9 QSB810	17-7/8" x 11-1/8" x 8"	69 lbs



AVAILABLE on pg. 29



1275-SB801

400 lb. LOAD CAPACITY PER SHELF



1239-SB807



1275-SB802



1275-SB809



WR8-801

COMPLETE PACKAGES WITH BINS



AVAILABLE on pg. 29

800 lb. LOAD CAPACITY PER SHELF



MOBILIZE YOUR WIRE SHELVING

DB - Donut Bumper
Non-marking donut bumper used to protect walls and help cushion impact.

WR-00H (Mobile Kit)*
Set of four swivel thermoplastic resin 5" x 1-1/4" casters, two with brakes. 1,200 lb. load capacity.
*Mobile kits recommended only for shelves 18" and deeper.

STORE-MAX 8" Shelf Bin Wire Shelving Systems - Complete Packages

- Easy boltless assembly
- Wire allows air to circulate as well as provides ideal product visibility
- Durable chrome finish ensures years of heavy-duty dependability and service
- All welded shelf construction is supported with super strong wire trusses to provide 800 lb. capacity per shelf

Bins available in: ● Blue ● Red ● Yellow ● Clear (One color per unit)

MODEL NO.	NO. OF BINS	BIN DIMENSIONS L" x W" x H"	SHIP WGT
12"W x 36"L x 74"H - 8 Shelf Systems			
WR8-801	49 QSB801	11-5/8" x 4-3/8" x 8"	100 lbs
WR8-802	35 QSB802	11-5/8" x 6-5/8" x 8"	103 lbs
WR8-807	28 QSB807	11-5/8" x 8-3/8" x 8"	102 lbs
WR8-809	21 QSB809	11-5/8" x 11-1/8" x 8"	101 lbs
18"W x 36"L x 74"H - 8 Shelf Systems			
WR8-803	49 QSB803	17-7/8" x 4-3/8" x 8"	150 lbs
WR8-804	35 QSB804	17-7/8" x 6-5/8" x 8"	142 lbs
WR8-808	28 QSB808	17-7/8" x 8-3/8" x 8"	138 lbs
WR8-810	21 QSB810	17-7/8" x 11-1/8" x 8"	141 lbs
24"W x 36"L x 74"H - 8 Shelf Systems			
WR8-805	49 QSB805	23-5/8" x 4-3/8" x 8"	194 lbs
WR8-806	35 QSB806	23-5/8" x 6-5/8" x 8"	177 lbs
WR8-814	28 QSB814	23-5/8" x 8-3/8" x 8"	176 lbs
WR8-816	21 QSB816	23-5/8" x 11-1/8" x 8"	169 lbs

STORE-MAX 8" Complete Bin Center

Complete bin systems are available with 4 different size bin options on a 12"W x 36"L x 39"H unit. This all-purpose bin center is an economical high density storage system that provides easy visibility to stored contents.

Bins available in: ● Blue ● Red ● Yellow ● Clear (One color per unit)

MODEL NO.	NO. OF BINS	BIN DIMENSIONS L" x W" x H"	SHIP WGT
12"W x 36"L x 39"H - 4 Shelf Systems			
WR4-39-1236-801	21 QSB801	11-5/8" x 4-3/8" x 8"	80 lbs
WR4-39-1236-802	15 QSB802	11-5/8" x 6-5/8" x 8"	78 lbs
WR4-39-1236-807	12 QSB807	11-5/8" x 8-3/8" x 8"	77 lbs
WR4-39-1236-809	9 QSB809	11-5/8" x 11-1/8" x 8"	77 lbs



WR8-802



WR8-809



WR4-39-1236-807

Super Tuff Euro Drawers



Super Tuff Euro Drawers are available in nine sizes and four colors and are designed for efficient organization of heavy parts, supplies, tools or equipment. Super Tuff Euro Drawers are injection molded from virgin grade high impact polystyrene and are virtually unbreakable. These heavy-duty drawers can be used on Quantum's open and closed shelf units and pick racks.

Available in: ● Blue ● Red ● Yellow ● Gray

MODEL NO.	OUTSIDE DIMENSIONS L" x W" x H"*	INSIDE DIMENSIONS L" x W" x H"	CTN QTY	CTN WGT	NUMBER OF DIVIDER SLOTS	DIVIDER	DIV CTN QTY
QED401	11-5/8" x 5-9/16" x 2-1/8"	10-1/4" x 5-1/8" x 2"	24	17 lbs	8	DIV401	4
QED501	11-5/8" x 3-3/4" x 4-5/8"	10-1/4" x 3-1/4" x 4-3/8"	24	19 lbs	8	DIV501/604	4
QED601	11-7/8" x 5-9/16" x 4-5/8"	10-3/4" x 5-1/8" x 4-3/8"	24	24 lbs	8	DIV6123	4
QED701	11-5/8" x 8-3/8" x 4-5/8"	10-1/4" x 7-3/4" x 4-3/8"	24	31 lbs	8	DIV701/606	4
QED801	11-5/8" x 11-1/8" x 4-5/8"	10-1/4" x 10-5/8" x 4-3/8"	12	19 lbs	8	DIV801	4
QED604	17-5/8" x 3-3/4" x 4-5/8"	16-1/2" x 3-1/4" x 4-1/4"	24	29 lbs	15	DIV501/604	4
QED602	17-3/4" x 5-9/16" x 4-5/8"	16-1/2" x 5-1/8" x 4-3/8"	24	32 lbs	13	DIV6123	4
QED606	17-5/8" x 8-3/8" x 4-5/8"	16-1/4" x 7-7/8" x 4-3/8"	24	46 lbs	13	DIV701/606	4
QED603	24" x 5-9/16" x 4-5/8"	22-5/8" x 5-1/8" x 4-3/8"	12	25 lbs	18	DIV6123	4

*Rear tab adds an additional 3/8" to rear height

PERFORMANCE FEATURES:

- Available in 9 sizes
- Bins are injection molded from a virgin grade high impact polystyrene and are virtually unbreakable
- Drawers are completely waterproof
- Drawers are oil and chemical resistant
- Smooth front curved pull handle has ample room for adhesive labels or bar codes
- Front handle has 3/4" opening for convenient easy gripping
- Full width back ledge ensures spill free use
- Optional dividers are full height for subdividing bins and prevents mixing of parts
- Available in four colors ideal for color coding inventory: Blue, Yellow, Red and Gray

9 SIZES AND 4 COLORS AVAILABLE

Full width back ledge ensures spill free use when used on shelving

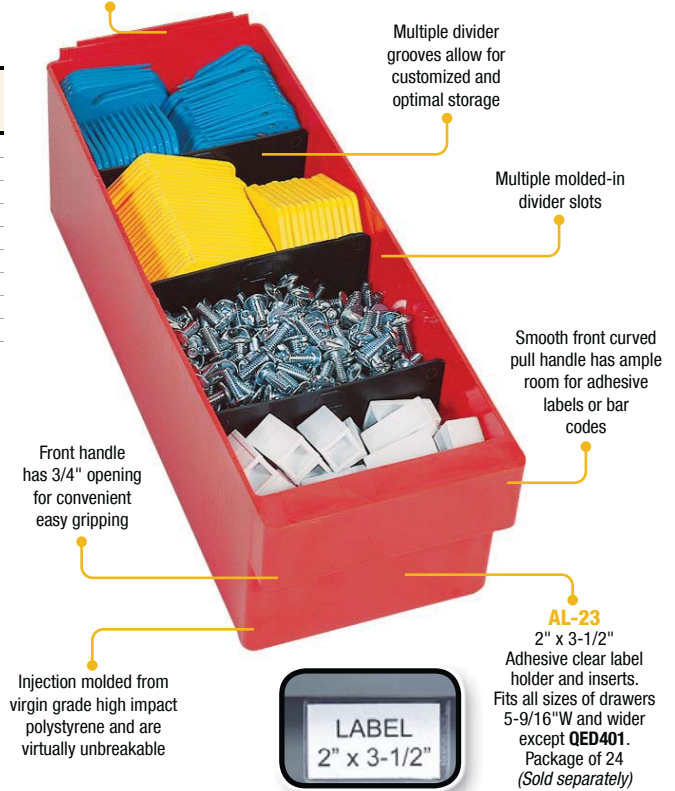

Multiple divider grooves allow for customized and optimal storage

Multiple molded-in divider slots

Smooth front curved pull handle has ample room for adhesive labels or bar codes

Front handle has 3/4" opening for convenient easy gripping

Injection molded from virgin grade high impact polystyrene and are virtually unbreakable

AL-23
2" x 3-1/2"
Adhesive clear label holder and inserts. Fits all sizes of drawers 5-9/16"W and wider except QED401. Package of 24 (Sold separately)

12" Deep Euro Drawers



HEAVY-DUTY DRAWERS VIRTUALLY UNBREAKABLE

18" Deep Euro Drawers



24" Deep Euro Drawer





CL1875-624
Closed Unit
(Complete with side and back panels)

Closed and Open Shelving Systems with Super Tuff Drawers
- Complete Packages

Save time locating parts using our tough Euro Drawers with our sturdy open or closed steel shelving. 36" wide x 75" or 39" high units offer heavy-duty, high grade shelving with a 400 lb. capacity per shelf. Closed shelving provides a dust free environment for stored parts.



1239-601
Open Unit
(No side or back panels)

COMPLETE PACKAGES WITH BINS

400 lb.
LOAD CAPACITY PER SHELF

HIGH DENSITY, HEAVY-DUTY, DUST FREE AND SECURE STORAGE

MORE ECONOMICAL SOLUTION COMPARED TO HIGHER COST STEEL DRAWER UNITS

Drawers available in: ● Blue ● Yellow ● Red ● Gray (One color per unit)

CLOSED UNITS		OPEN UNITS		BIN DIMENSIONS L" x W" x H"	NO. OF BINS	SHIP WGT
MODEL NO.	MODEL NO.	MODEL NO.	MODEL NO.			
12"D x 36"W x 75"H - 13 Shelf Systems						
CL1275-401*	1275-401*	11-5/8" x 5-9/16" x 2-1/8"	108 QED401	231 lbs		
CL1275-501	1275-501	11-5/8" x 3-3/4" x 4-5/8"	108 QED501	215 lbs		
CL1275-601	1275-601	11-5/8" x 5-9/16" x 4-5/8"	72 QED601	192 lbs		
CL1275-701	1275-701	11-5/8" x 8-3/8" x 4-5/8"	48 QED701	171 lbs		
CL1275-801	1275-801	11-5/8" x 11-1/8" x 4-5/8"	36 QED801	189 lbs		
CL1275-000	1275-000	12" Deep Steel Unit Only - No Bins		129 lbs		
18"D x 36"W x 75"H - 13 Shelf Systems						
CL1875-602	1875-602	17-7/8" x 5-9/16" x 4-5/8"	72 QED602	266 lbs		
CL1875-604	1875-604	17-7/8" x 3-3/4" x 4-5/8"	108 QED604	287 lbs		
CL1875-624	1875-624	17-7/8" x 5-9/16" x 4-5/8"	36 QED602	276 lbs		
CL1875-606	1875-606	17-7/8" x 3-3/4" x 4-5/8"	54 QED604	276 lbs		
CL1875-606	1875-606	17-7/8" x 8-3/8" x 4-5/8"	48 QED606	237 lbs		
CL1875-000	1875-000	18" Deep Steel Unit Only - No Bins		167 lbs		
24"D x 36"W x 75"H - 13 Shelf Systems						
CL2475-603	2475-603	23-7/8" x 5-9/16" x 4-5/8"	72 QED603	360 lbs		
12"D x 36"W x 39"H - 7 Shelf Systems						
CL1239-401**	1239-401**	11-5/8" x 5-9/16" x 2-1/8"	54 QED401	121 lbs		
CL1239-601	1239-601	11-5/8" x 5-9/16" x 4-5/8"	36 QED601	99 lbs		
CL1239-000	1239-000	12" Deep Steel Unit Only - No Bins		70 lbs		
18"D x 36"W x 39"H - 7 Shelf Systems						
CL1839-602	1839-602	17-7/8" x 5-9/16" x 4-5/8"	36 QED602	139 lbs		
CL1839-604	1839-604	17-7/8" x 3-3/4" x 4-5/8"	54 QED604	155 lbs		
CL1839-624	1839-624	17-7/8" x 5-9/16" x 4-5/8"	18 QED602	147 lbs		
CL1839-000	1839-000	3-3/4" x 4-5/8"	27 QED604	147 lbs		
CL1839-000	1839-000	18" Deep Steel Unit Only - No Bins		89 lbs		
24"D x 36"W x 39"H - 7 Shelf Systems						
CL2439-603	2439-603	23-7/8" x 5-9/16" x 4-5/8"	176 QSB101	198 lbs		

*Unit includes 19 shelves **Unit includes 10 shelves



Euro Drawer Sloped Shelving Systems - Complete Packages

COMPLETE PACKAGES WITH BINS

Sturdy steel racks with Super Tuff Euro Drawers create an efficient flow system. Sloped shelving provides easy access to stored items. Drawers can be removed from racks easily. These gray colored baked enamel, free standing racks assemble easily. Mobile unit has a 1,200 lb. capacity and is equipped with 2 swivel, 2 rigid casters. One drawer color per system.



QPRHA-601
Bench Pick Rack
250 lb. capacity.

SLOPED SHELVES, EASY ACCESS, MOST POPULAR AND VERSATILE STORAGE SYSTEMS SOLD

Drawers available in: ● Blue ● Yellow ● Red ● Gray

(One color per unit)

MODEL NO.	NO. OF BINS	BIN DIMENSIONS L" x W" x H"	SHIP WGT
12-1/2"L x 36"W x 23"H - 3 Shelf Bench Rack Systems			
QPRHA-501	27 QED501	11-5/8" x 3-3/4" x 4-5/8"	48 lbs
QPRHA-601	18 QED601	11-5/8" x 5-9/16" x 4-5/8"	42 lbs
QPRHA-701	12 QED701	11-5/8" x 8-3/8" x 4-5/8"	42 lbs
QPRHA-567	9 QED501 6 QED601 4 QED701	11-5/8" x 3-3/4" x 4-5/8" 11-5/8" x 5-9/16" x 4-5/8" 11-5/8" x 8-3/8" x 4-5/8"	44 lbs
QPRHA-000	12-1/2" Deep Bench Rack Only - No Bins		26 lbs
12"L x 36"W x 63-1/2"H - Single Sided 8 Shelf Rack Systems			
QPRS-501	72 QED501	11-5/8" x 3-3/4" x 4-5/8"	110 lbs
QPRS-601	48 QED601	11-5/8" x 5-9/16" x 4-5/8"	91 lbs
QPRS-701	32 QED701	11-5/8" x 8-3/8" x 4-5/8"	95 lbs
QPRS-801	24 QED801	11-5/8" x 11-1/8" x 4-5/8"	93 lbs
QPRS-5678	18 QED501 12 QED601 8 QED701 6 QED801	11-5/8" x 3-3/4" x 4-5/8" 11-5/8" x 5-9/16" x 4-5/8" 11-5/8" x 8-3/8" x 4-5/8" 11-5/8" x 11-1/8" x 4-5/8"	99 lbs
QPRS-000	12" Deep Single Sided Rack Only - No Bins		53 lbs
18"L x 36"W x 63-1/2"H - Single Sided 8 Shelf Rack Systems			
QPRS-604	72 QED604	17-7/8" x 3-3/4" x 4-5/8"	165 lbs
QPRS-602	48 QED602	17-7/8" x 5-9/16" x 4-5/8"	142 lbs
QPRS-606	32 QED606	17-7/8" x 8-3/8" x 4-5/8"	139 lbs
QPRS18-000	18" Deep Single Sided Rack Only - No Bins		78 lbs
24"L x 36"W x 60"H - Double Sided 16 Shelf Rack Systems			
QPRD-501	144 QED501	11-5/8" x 3-3/4" x 4-5/8"	220 lbs
QPRD-601	96 QED601	11-5/8" x 5-9/16" x 4-5/8"	190 lbs
QPRD-701	64 QED701	11-5/8" x 8-3/8" x 4-5/8"	189 lbs
QPRD-801	48 QED801	11-5/8" x 11-1/8" x 4-5/8"	186 lbs
QPRD-5678	36 QED501 24 QED601 16 QED701 12 QED801	11-5/8" x 3-3/4" x 4-5/8" 11-5/8" x 5-9/16" x 4-5/8" 11-5/8" x 8-3/8" x 4-5/8" 11-5/8" x 11-1/8" x 4-5/8"	197 lbs
QPRD-000	24" (12" on each side) Deep Double Sided Rack Only - No Bins		106 lbs
QDU-00*	Mobile Kit - Mobilizes All 24" Deep Double Sided Units		25 lbs
36"L x 36"W x 60"H - Double Sided 16 Shelf Rack Systems			
QPRD-604	144 QED604	17-7/8" x 3-3/4" x 4-5/8"	330 lbs
QPRD-602	96 QED602	17-7/8" x 5-9/16" x 4-5/8"	284 lbs
QPRD-606	64 QED606	17-7/8" x 8-3/8" x 4-5/8"	279 lbs
QPRD18-000	36" (12" on each side) Deep Double Sided Rack Only - No Bins		156 lbs
QDU-18*	Mobile Kit - Mobilizes All 36" Deep Double Sided Units		35 lbs

*1,200 lb. load capacity. 2 rigid, 2 swivel with brake hard rubber casters.



QPRS-601
Single Sided Pick Rack
400 lb. capacity.

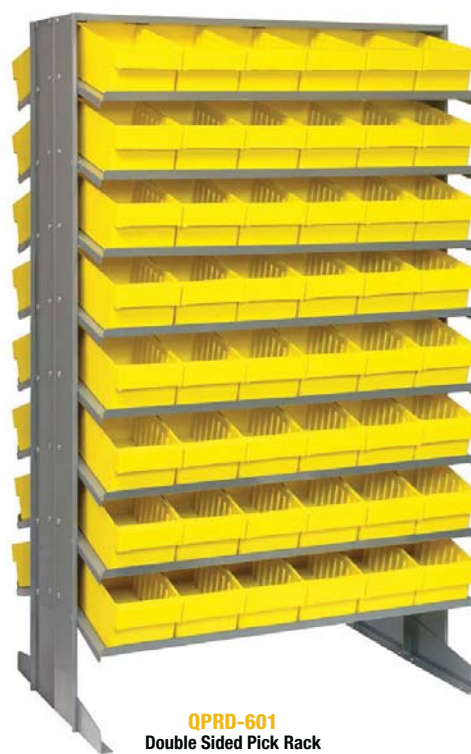

QPRD-601
Double Sided Pick Rack
800 lb. capacity.

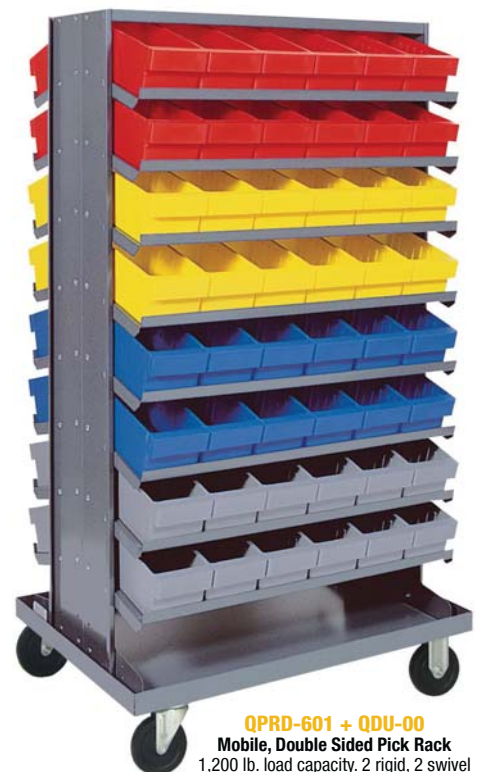

QPRD-601 + QDU-00
Mobile, Double Sided Pick Rack
1,200 lb. load capacity. 2 rigid, 2 swivel with brake hard rubber casters.

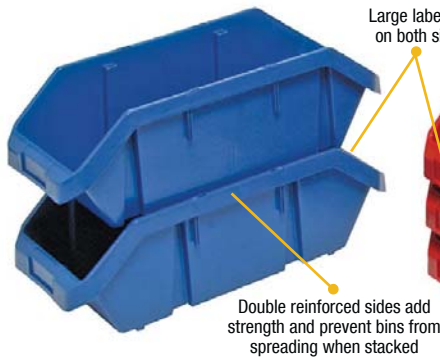

STACK 'EM

Double reinforced sides add strength and prevent bins from spreading when stacked

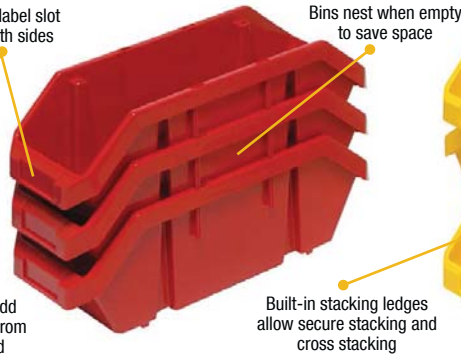

NEST 'EM

Large label slot on both sides

Bins nest when empty to save space

Built-in stacking ledges allow secure stacking and cross stacking



CROSS STACK 'EM

Create up to 4 Compartments



QP1265 Shown with optional Dividers CD1265/LD1265

QuickPick Bin



6 SIZES AND 3 COLORS AVAILABLE

Dividers

These heavy-duty, polypropylene storage bins provide an open hopper front and back, allowing double sided access to stored parts. Bins stack one on top of the other, both vertically and cross-wise, and nest when empty for space efficiency. Optional dividers may be used front to back, side to side, or both at the same time, dividing the bin into four sections. A molded in label holder on both the front and back of the bin allows for easy parts identification. Bins can be used on standard metal or wire shelving as well as on desks, bench tops or work stations.

Available in: Blue Red Yellow

Table with columns: MODEL NO., DIMENSIONS L" x W" x H", X"*, CTN QTY, CTN WGT, CROSS DIVIDER, CTN QTY, LENGTH DIVIDER, CTN QTY, CLEAR LABEL HOLDER & INSERT

*X" dimensions is inside flat bottom length

Heavy-Duty Wire Shelving with QuickPick Bins - Complete Packages

These unique shelving packages provide double sided access to stored parts. QuickPick Bins allow two users to access stored product at the same time. This ergonomic, space efficient work station is the ultimate space saver. Shelving systems measure 18"W x 36"L x 74"H and may be ordered with or without a mobile kit. These heavy-duty systems offer an 800 lb. capacity per shelf. Optional dividers may be used front to back, side to side or both at the same time, dividing the bin into four sections. A molded in label holder on both the front and back of the bin allows for easy part identification.

Bins available in: Blue Red Yellow (One color per unit)

Table with columns: MODEL NO., NO. OF BINS, DIMENSIONS L" x W" x H", SHIP WGT

Mobile Kit WR-00H* Mobilizes Wire Shelving Unit 14 lbs

*Set of four swivel thermoplastic resin 5" x 1-1/4" casters, two with brakes. 1,200 lb. load capacity. Mobile kits recommended only for shelves 18" and deeper.

800 lb. LOAD CAPACITY PER SHELF



W7-12-26



LTR-1253 Clear Label Holder & Insert Clear label holders and laser label inserts. Fits all QuickPick Bins. Package of 25.

Optional dividers may be used front to back, side to side or both at the same time, dividing the bin into four sections.

THE MOST VERSATILE BIN IN THE INDUSTRY WITH DOUBLE SIDED ACCESS



WRC3-1836-1867

QuickPick Bin Mobile Wire Cart

Carts are available in a 2 or 3 shelf configuration complete with four casters (all swivel, two with brakes). Overall dimensions: 18"W x 36"L x 37-1/2"H. Mobile cart is easy to assemble. One color per cart.

Bins available in: Blue Red Yellow (One color per unit)

Table with columns: MODEL NO., NO. OF BINS, DIMENSIONS L" x W" x H", CTN WGT



Latch Containers & Wire Shelving System - Complete Packages



Quantum's new Latch Containers feature heavy-duty latches on each end that snap lock providing a tight and secure fit. Once latch is engaged parts inside are fully protected from dirt or getting wet. These durable and ultra-strong containers can hold up to 75 lbs. Injection molded from durable, high impact polypropylene. Lids feature reinforced ribs that allow totes to safely and securely stack on top of each other.

Available in: ● Black ● Clear

MODEL NO.	OUTSIDE DIMENSIONS L" x W" x H"	INSIDE TOP DIMENSIONS L" x W" x H"	INSIDE BOTTOM DIMENSIONS L" x W"	CAP GAL	CTN QTY	CTN WGT LBS	LID	CTN QTY
LC191507	NEW 21" x 15-7/8" x 7-3/4"	18-3/8" x 14-5/8" x 7-1/4"	15-7/8" x 12-7/8"	7.03	6	12 lbs	LID1915	6
LC191507CL	NEW 21" x 15-7/8" x 7-3/4"	18-3/8" x 14-5/8" x 7-1/4"	15-7/8" x 12-7/8"	7.03	6	12 lbs	LID1915CL	6



LID1915 and LID1915CL
Latch Container Lid



LC191507CL
and **LID1915CL**

NEW

CONTAINERS HOLD UP TO 75 lbs.



LC191507
and **LID1915**



LC191507CL
Containers Nesting



LC191507CL
and **LID1915CL**
Containers Stacked with Lid



WR6-191507CL
21"W x 36"L x 74"H
6 shelves with 12 **LC191507CL**
and 12 **LID1915CL**



WR6-191507
21"W x 36"L x 74"H
6 shelves with 12 **LC191507**
and 12 **LID1915**



MOBILIZE YOUR WIRE SHELVING

DB - Donut Bumper
Non-marking donut bumper used to protect walls and help cushion impact.

WR-00H (Mobile Kit)*
Set of four swivel thermoplastic resin 5" x 1-1/4" casters, two with brakes. Can be used with all units shown. 1,200 lb. load capacity. *Mobile kits recommended only for shelves 18" and deeper.



11 SIZES AND 4 COLORS AVAILABLE



DIVIDERS

Containers can be divided by length and/or width allowing a subdivision down to a 1-1/8" square compartment size. Available in Gray.



SNAP ON COVERS

Snap on covers protect contents from damage or dust during shipping and storage.



CLEAR LABEL HOLDER

Fits any size container. Three sizes to choose from. Attach via Velcro fastening.

NEW SIZES

NEW
DG92050

NEW
DG91025



Dividable Grid Containers



Shown with optional Clear Label Holder



Heavy-duty Dividable Grid Containers can be used in industrial, commercial, electronic and health care industries for storage, assembly, fabrication and distribution applications. These containers offer the safest and most efficient method for compartmentalizing and protecting small to medium sized parts. Dividers allow you to customize the container's interior to meet your exact needs. Containers and covers are available in 4 colors.

Available in: ● Blue ● Gray ● Red ● Clear

MODEL NO.	OUTSIDE DIMENSIONS L" x W" x H"	INSIDE DIMENSIONS L" x W" x H"	CTN QTY	CTN WGT	LONG DIVIDER	CTN SHORT DIVIDER	CTN COVER	CTN QTY
DG91025 NEW	10-7/8" x 8-1/4" x 2-1/2"	9-3/16" x 6-9/16" x 2"	20	16 lbs	DL91025	6	DS91025	6
DG91035	10-7/8" x 8-1/4" x 3-1/2"	9-3/16" x 6-9/16" x 3"	20	24 lbs	DL91035	6	DS91035	6
DG91050	10-7/8" x 8-1/4" x 5"	9-3/16" x 6-9/16" x 4-1/2"	20	32 lbs	DL91050	6	DS91050	6
DG92035	16-1/2" x 10-7/8" x 3-1/2"	14-7/8" x 9-1/4" x 3"	12	23 lbs	DL92035	6	DS92035	6
DG92050 NEW	16-1/2" x 10-7/8" x 5"	14-7/8" x 9-1/4" x 4-1/2"	12	25 lbs	DL92050	6	DS92050	6
DG92060	16-1/2" x 10-7/8" x 6"	14-7/8" x 9-1/4" x 5-1/2"	8	20 lbs	DL92060	6	DS92060	6
DG92080	16-1/2" x 10-7/8" x 8"	14-7/8" x 9-1/4" x 7-1/2"	8	27 lbs	DL92080	6	DS92080	6
DG93030	22-1/2" x 17-1/2" x 3"	20-5/8" x 15-5/8" x 2-1/2"	6	20 lbs	DL93030	6	DS93030	6
DG93060	22-1/2" x 17-1/2" x 6"	20-5/8" x 15-5/8" x 5-1/2"	3	16 lbs	DL93060	6	DS93060	6
DG93080	22-1/2" x 17-1/2" x 8"	20-5/8" x 15-5/8" x 7-1/2"	3	19 lbs	DL93080	6	DS93080	6
DG93120	22-1/2" x 17-1/2" x 12"	20-5/8" x 15-5/8" x 11-1/2"	3	23 lbs	DL93120	6	DS93120	6

CLEAR VIEW
AVAILABLE on pg. 31



DG92060
Shown with optional Clear Dust Cover Acrylic Inlay

Clear Dust Cover Acrylic Inlays

Clear Acrylic Dust Cover Inlays keep stored items visible while protecting against airborne dust and other contaminants. Cover lays inside on recessed rim of container.

MODEL NO.	FITS BIN MODEL NO.	CTN QTY
DDC91000CL	DG91025, DG91035, DG91050	10
DDC92000CL	DG92035, DG92050, DG92060, DG92080	4
DDC93000CL	DG93030, DG93060, DG93080, DG93120	3



DG92060 and DG93060
Shown with optional Dividers and Clear Covers

Clear Label Holders

MODEL NO.	DIMENSIONS H" x W"	FITS BIN MODEL NO.	CTN QTY
LBL2X8	2" x 8"	DG91025, DG91035, DG92035, DG93030	6
LBL3X5	3" x 5"	DG91050, DG92050, DG92060, DG93060	6
LBL5X8	5" x 8"	DG92080, DG93080, DG93120	6

Clear Covers

MODEL NO.	FITS BIN MODEL NO.	CTN QTY
COV91000CL	DG91025, DG91035, DG91050	10
COV92000CL	DG92035, DG92050, DG92060, DG92080	4
COV93000CL	DG93030, DG93060, DG93080, DG93120	3



9 SIZES AND 4 COLORS AVAILABLE

CLEAR VIEW
AVAILABLE on pg. 30



snh010

All nine sizes of totes have ability to use our optional 3" x 5" clear label holder. It securely attaches to tote with or without lid for easy part identification.



AL-35

3" x 5" Clear Adhesive Label Holder and Inserts attaches securely to container for easy part identification. Package of 24.



Optional lid snaps on tightly and securely to protect container contents. As pictured, lids can be fastened and locked for added security.

Genuine stack and nest totes



These heavy-duty, tough, and dependable stack and nest totes are the ultimate reusable container for storing and transporting your valuable items in any application. These proven containers are available in nine sizes and three colors for efficiency and inventory control.

NEW CLEAR COLOR
See pg. 30

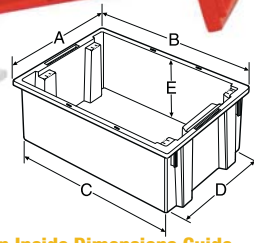

Bin Inside Dimensions Guide
A (top width) B (top length) E (height)
C (bottom length) D (bottom width)

Available in: ● Blue ● Gray ● Red ● Clear

MODEL NO.	OUTSIDE DIMENSIONS L" x W" x H"	A	B	INSIDE DIMENSIONS		E	CAPACITY (CU FT)	CTN QTY	CTN WGT	LID	CTN QTY			
				C	D									
snt180	18" x 11" x 6"	10"	16"	15-1/4"	9-3/8"	5-7/8"	0.50	6	12 lbs	LID181	6			
snt185	18" x 11" x 9"	10"	16"	15-1/8"	9-1/8"	8-7/8"	0.76	6	15 lbs	LID181	6			
snt190	19-1/2" x 15-1/2" x 10"	14-1/2"	17"	16"	13-1/4"	9-7/8"	1.20	6	23 lbs	LID191	6			
snt195	19-1/2" x 15-1/2" x 13"	14-1/2"	17"	15-7/8"	13-3/8"	12-7/8"	1.70	6	26 lbs	LID191	6			
snt200	19-1/2" x 13-1/2" x 8"	12-3/8"	17-7/8"	16-3/8"	11-1/2"	7-7/8"	0.80	6	19 lbs	LID201	6			
snt225	23-1/2" x 19-1/2" x 10"	18-1/4"	20-7/8"	19-3/8"	16-7/8"	9-7/8"	2.00	3	18 lbs	LID231	3			
snt230	23-1/2" x 19-1/2" x 13"	18-1/8"	20-7/8"	19-1/2"	16-7/8"	12-7/8"	2.60	3	22 lbs	LID231	3			
snt240	23-1/2" x 15-1/2" x 12"	14-1/4"	20-7/8"	19-5/8"	13"	11-7/8"	1.70	3	18 lbs	LID241	3			
snt300	29-1/2" x 19-1/2" x 15"	18-1/4"	26-5/8"	25-1/8"	16-5/8"	14-7/8"	3.70	3	31 lbs	LID301	3			
snh010	Clear Label Holder - 3" x 5" (Fits all tote sizes)										6	1 lb	-	-

stack and nest totes PERFORMANCE FEATURES:

- Available in 9 sizes
- Standard colors: Blue, Gray and Red
- Totes are injection molded from high-density polypropylene material and are manufactured from FDA and USDA approved materials
- stack and nest totes will not corrode, bend out of shape, are unaffected by chemicals and are waterproof
- Reusable container will stack with or without lids for maximum storage and shipping
- snt's have the unique ability to stack or they can be turned 180° to nest when empty saving valuable space
- Optional lids for totes can be secured with nylon ties
- Textured bottoms ensure safe and easy, non-slip grip in transit on conveyors

LIGHTWEIGHT, HEAVY-DUTY HDPE SIMPLE SNAP-TOGETHER DESIGN

Polymer Dunnage Rack

MODEL NO.	DIMENSIONS W" x L" x H"	SHIP WGT
Ventilated Top		
362412DPP	24" x 36" x 12"	13 lbs
363612DPP	36" x 36" x 12"	22 lbs
482412DPP	24" x 48" x 12"	19 lbs
662412DPP	24" x 66" x 12"	23 lbs
663612DPP	36" x 66" x 12"	37 lbs
962412DPP	24" x 96" x 12"	34 lbs
963612DPP	36" x 96" x 12"	53 lbs
Solid Top		
362412DPS	24" x 36" x 12"	17 lbs
363612DPS	36" x 36" x 12"	26 lbs
482412DPS	24" x 48" x 12"	21 lbs
662412DPS	24" x 66" x 12"	28 lbs
663612DPS	36" x 66" x 12"	49 lbs
962412DPS	24" x 96" x 12"	41 lbs
963612DPS	36" x 96" x 12"	64 lbs



500-2,700 lb. LOAD CAPACITY

For more detailed info See pg. 129



Chrome Wire Shelving System with Genuine stack and nest totes

Offering 600-800 lb. load capacity per shelf, this chrome wire shelving system with totes is a must have for archival storage, heavy-duty parts organization or inventory control applications. With three packages to choose from offering three colors choices for the bins, this system can be used just about anywhere. System may be made mobile with the addition of the **WR-00H** mobile kit. See **pg. 66** for additional information and to order optional accessories.

600-800 lb. LOAD CAPACITY PER SHELF

MODEL NO.	NO. OF SHELVES	NO. OF BINS	BIN DIMENSIONS L" x W" x H"	SHIP WGT
18"W x 48"L x 74"H - Wire Shelving Systems with stack and nest totes - Totes are available in Gray, Blue, Red and Clear				
WR9-36180	9	36 snt180	18" x 11" x 6"	178 lbs
WR6-24185	6	24 snt185	18" x 11" x 9"	136 lbs
24"W x 66"L x 63"H - Wire Shelving System with stack and nest totes - Totes are available in Gray, Blue, Red and Clear				
WR4-12225	4	12 snt225	23-1/2" x 19-1/2" x 10"	170 lbs



AVAILABLE on pg. 30

WR9-36180
Shown with optional lid and label holders (Sold separately)



MOBILIZE YOUR WIRE SHELVING

DB - Donut Bumper

Non-marking donut bumper used to protect walls and help cushion impact.

WR-00H (Mobile Kit)

Set of four swivel thermoplastic resin 5" x 1-1/4" casters, two with brakes. Can be used with all units shown. 1,200 lb. load capacity.

Chrome Mobile Wire Shelving Systems with Cross Stack Tubs & Quantub Nesting Tote

These unique packages provide a storage solution for large, bulky items. These heavy-duty tubs provide easy access to stored parts for assembly areas, picking stations or inventory control. With three packages to choose from, these strong durable totes provide a durable solution for most applications. See **pg. 68** for more information.

MODEL NO.	NO. OF SHELVES	NO. OF BINS	BIN DIMENSIONS L" x W" x H"	SHIP WGT
24"W x 60"L x 69"H - Mobile, Wire Shelving System with QuanTub Totes - Totes are available in Gray and Blue				
MWR4-2419-9	4	12 TUB2419-9	24-1/2" x 19" x 9-1/2"	175 lbs
18"W x 36"L x 69"H - Mobile, Wire Shelving System with Cross Stack Tubs - Tubs are available in Gray, Blue and White				
MWR7-1711-8	7	24 TUB1711-8	17-1/4" x 11" x 8"	151 lbs
MWR5-1711-12	5	15 TUB1711-12	17-1/4" x 11" x 12"	118 lbs

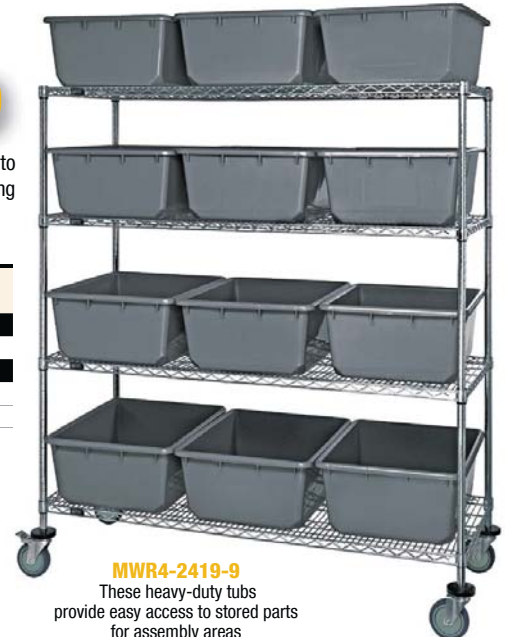

MWR4-2419-9
These heavy-duty tubs provide easy access to stored parts for assembly areas

COMPLETE PACKAGES WITH BINS

WR7-92080
Allow for multiple compartment configurations within each bin



Chrome Wire Shelving System with Dividable Grid Containers



AVAILABLE on pg. 31

Same durable chrome wire shelving combined with Quantum's Dividable Grid Containers. These containers allow for multiple compartment configurations within each bin. Offering four different packages, these systems are ideal for small and medium parts storage. System may be made mobile with the addition of the **WR-00H** mobile kit. See **pg. 65** for additional container information and to order optional container accessories.

600-800 lb. LOAD CAPACITY PER SHELF

MODEL NO.	NO. OF SHELVES	NO. OF BINS	BIN DIMENSIONS L" x W" x H"	SHIP WGT
18"W x 48"L x 74"H - Wire Shelving Systems with Dividable Grid Containers - Containers are available in Gray, Blue, Red and Clear				
WR9-92060	9	36 DG92060	16-1/2" x 10-7/8" x 6"	210 lbs
WR7-92080	7	24 DG92080	16-1/2" x 10-7/8" x 8"	174 lbs
24"W x 60"L x 63"H - Wire Shelving System with Dividable Grid Containers - Containers are available in Gray, Blue, Red and Clear				
WR12-93030	12	36 DG93030	22-1/2" x 17-1/2" x 3"	274 lbs
WR9-93060	9	24 DG93060	22-1/2" x 17-1/2" x 6"	254 lbs



Cross Stack Tubs



5 SIZES AND 5 COLORS AVAILABLE

Manufactured from approved USDA/FDA materials, totes nest when empty or can be turned 90° to cross stack. Easy access to items when stacked. Injection molded from durable, high impact polypropylene. Easy to clean. Built in handle grips and bottom grooves makes handling easy. Holds up to 100 lbs. per bin 1/4" drill hole pattern on bottom of bin allows for easy hole insertion for optional drainage and air flow.

Available in: ● Blue ● Gray ○ White **TUB2516-8/LID2516-8** also available in: ● Red ● Yellow

MODEL NO.	OUTSIDE DIMENSIONS L" x W" x H"	INSIDE BOTTOM DIMENSIONS L" x W"	CAP GAL	CTN QTY	CTN WGT	LID	CTN QTY
TUB1711-8	17-1/4" x 11" x 8"	13" x 7-1/2"	3.85	6	14 lbs	LID1711	6
TUB1711-12	17-1/4" x 11" x 12"	12-5/8" x 7"	5.51	6	17 lbs	LID1711	6
TUB2417-8	23-3/4" x 17-1/4" x 8"	19-5/8" x 13-3/4"	9.81	6	25 lbs	LID2417	6
TUB2417-12	23-3/4" x 17-1/4" x 12"	18-7/8" x 13-1/4"	14.38	6	30 lbs	LID2417	6
TUB2516-8	25-1/8" x 16" x 8-1/2"	20-1/2" x 13-3/8"	9.75	6	20 lbs	LID2516-8	6
SNH010	Six Clear Label Holders - 3" x 5"			6	1 lb	-	-

NEW COLORS



TUB2516-8
Nesting and Cross Stack

NEW COLORS



LID2516-8

Optional lid keeps stored items dust free. Tubs can still stack or cross stack with lids in place.

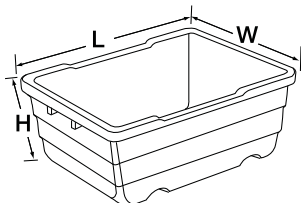

Bin Dimensions Guide
L (length) W (width) H (height)

QuanTub Nesting Tote



Manufactured of approved USDA/FDA materials, this tote is ideal in food service and storage and general product handling. Strong and durable tote is injection molded from high-density polypropylene. Each tote can hold up to 100 lbs. Tote is easy to clean. Rolled top rim for comfortable grip. Rounded corners add strength to stress points. Totes nest when empty and prevent jamming with rib top. 1/4" drill hole pattern on bottom of bin allows for easy hole insertion for optional air flow and drainage.

Available in: ● Blue ● Gray

MODEL NO.	OUTSIDE DIMENSIONS L" x W" x H"	INSIDE BOTTOM DIMENSIONS A" x B"	CAP GAL	CTN QTY	CTN WGT
TUB2419-9	24-1/2" x 19" x 9-1/2"	20-1/4" x 15-1/4"	14.6	6	33 lbs



TUB2419-9
Nesting

Polymer Dolly

DLY-3018 is 30"L x 18"W with padded rubber trim, available in Blue. Set of four 4" x 1-1/4" non-marking swivel poly casters. 1,000 lb. load capacity.

MODEL NO.	DESCRIPTION	CTN WGT
DLY-3018	Dolly with Padded Rubber Trim	19 lbs
HANDLE-DLY	32" Dolly Pull Rod with Handle	2 lbs



ATTACHED PULL RING
allows dolly to be pulled with ease



HANDLE-DLY
Dolly Pull Rod



Tub Racks - Complete Packages

All-welded aluminum Tub Rack transports and stores all types of product. Cart comes with four swivel 5" x 1" Polyolefin casters. Runners allow bins to slide in and out from both sides. Rack comes complete with tubs.

Tubs available in: ● Blue ● Gray ○ White ● Red ● Yellow

MODEL NO.	DIMENSIONS L" x W" x H"	NO. OF BINS	SHIP WGT
Tub Rack with Cross Stack Tubs			
Tub Dimensions 25-1/8"L x 16"W x 8-1/2"H			
TR1-2516-8	27" x 19" x 19"	1	13 lbs
TR2-2516-8	27" x 19" x 31"	2	25 lbs
TR3-2516-8	27" x 19" x 41"	3	33 lbs
TR4-2516-8	27" x 19" x 51"	4	46 lbs
TR5-2516-8	27" x 19" x 61"	5	54 lbs
TR6-2516-8	27" x 19" x 71"	6	58 lbs
TR12-2516-8 NEW	27" x 37" x 71"	12	114 lbs



NEW
COLORS &
12 TUB RACK

EACH BIN LEVEL WILL
SUPPORT UP TO
60 lbs.
(One Tub extended at a time)

**COMPLETE PACKAGES
WITH BINS**



TR12-2516-8
Comes with 12 TUB2516-8



TR1-2516-8
Comes with 1 TUB2516-8

TR2-2516-8
Comes with 2 TUB2516-8

TR3-2516-8
Comes with 3 TUB2516-8

TR4-2516-8
Comes with 4 TUB2516-8

TR5-2516-8
Comes with 5 TUB2516-8

TR6-2516-8
Comes with 6 TUB2516-8



Stackers - Heavy-Duty Straight Wall Stacking Container

Heavy-duty, straight wall containers maximize your space when used for shipping, storage or work-in progress. Greater strength and durability provided by reinforced corners allowing this strong container to hold the heaviest of parts. Containers are injection molded from high-density polyethylene. Straight wall design allows for modular stacking of all sizes on standard pallets. Hand grips on two sides make the container easy to handle and carry. Up to 175 lb. stack capacity.

Available in: ● Gray

MODEL NO.	OUTSIDE DIMENSIONS L" x W" x H"	INSIDE DIMENSIONS L" x W" x H"	CTN QTY	VOLUME (CU FT)	SHIP WGT	LID
RS01207-5	12" x 7-1/2" x 5"	9-3/4" x 5-1/2" x 4-7/8"	1	0.1	2 lbs	-
RS01215-5	12" x 15" x 5"	9-1/2" x 13" x 4-7/8"	1	0.3	2 lbs	LID1215
RS01215-7	12" x 15" x 7-1/2"	9-1/2" x 13" x 7"	1	0.5	3 lbs	LID1215
RS02415-5	24" x 15" x 5"	21-1/2" x 13" x 4-7/8"	1	0.7	4 lbs	LID2415
RS02415-7	24" x 15" x 7-1/2"	21-1/2" x 13" x 7"	1	1.1	5 lbs	LID2415
RS02415-9	24" x 15" x 9-1/2"	21-1/2" x 13" x 9"	1	1.4	5 lbs	LID2415
RS02422-11*	24" x 22-1/2" x 11"	21-1/2" x 20-1/2" x 10-1/4"	1	3.5	8 lbs	-

*Cannot be used on **DLY-2415**. Use with **DLY-3018** Dolly.

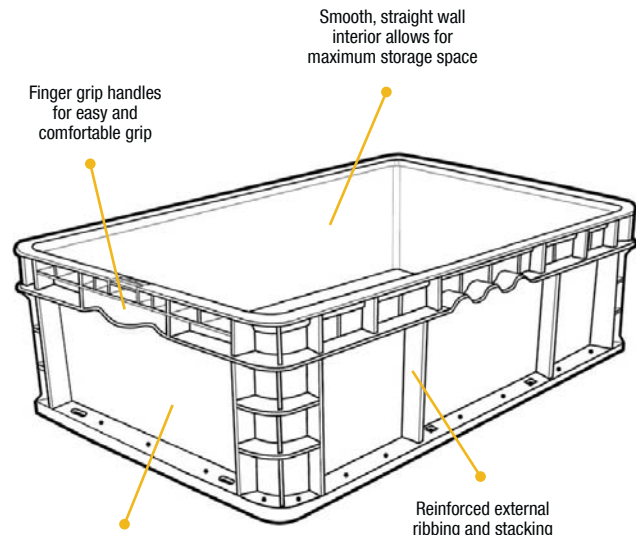
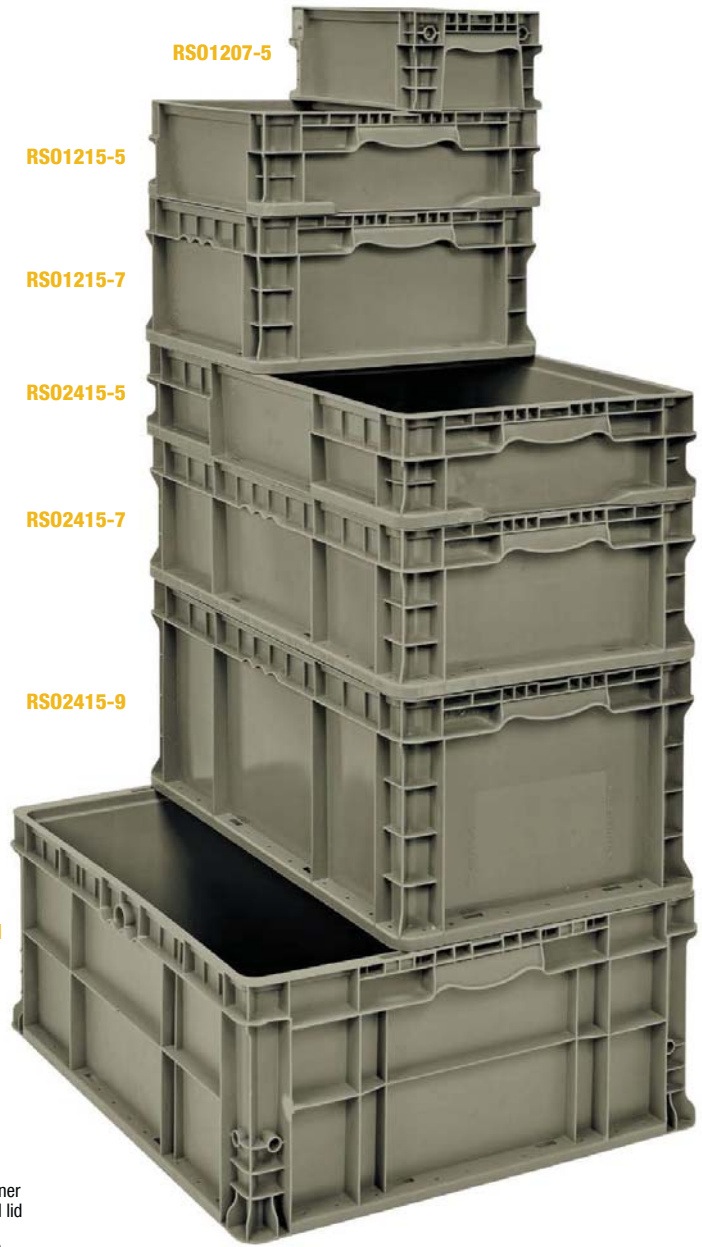

RS02422-11

Straight Wall container shown with optional lid **LID2415** (Sold separately)



DLY-2415

Interior Dimensions 24"L x 15"W
 Exterior Dimensions 28"L x 18-1/2"W

MOBILIZE YOUR BINS

Polymer Dollies

DLY-2415 is 24"L x 15"W with 1" Ledge, available in Black.

DLY-3018 is 30"L x 18"W with padded rubber trim, available in Blue.

Set of four 4" x 1-1/4" non-marking swivel poly casters.

Both dollies have 1,000 lb. load capacity.

MODEL NO.	DESCRIPTION	CTN WGT
DLY-2415	Dolly with 1" Ledge	14 lbs
DLY-3018	Dolly with Padded Rubber Trim	19 lbs

Bins sold separately



Stronger corner design means increased durability which translates to fewer damaged containers

Secure plastic hinges make containers safer to handle and easier to recycle at end-of-life

9 SIZES AVAILABLE



PLASTIC HINGE
NEW generation plastic hinge



Enhanced nesting lug increases strength when stacking nested containers

Redesigned lid features additional ribbing in critical impact areas

STRONG, RELIABLE, REUSABLE TOTES



NEW
STRONGER DESIGN

Polymer Dolly

DLY-2415 Dolly with 1" Ledge, available in Black. 1,000 lb. load capacity. Interior Dimensions 24"L x 15"W Exterior Dimensions 28"L x 18-1/2"W

MODEL NO.	DESCRIPTION	CTN WGT
DLY-2415	Dolly with 1" Ledge	14 lbs

Bins sold separately



QDL-2115

Distribution container has an optional 3" x 5" adhesive clear label holder and insert which attaches securely for easy part identification. Package of 24.



CUSTOM COLORS AVAILABLE

call for details



HOT STAMPING AVAILABLE
call for details

Heavy-Duty Attached Top Containers - Perfect for distribution and supply centers



Strong, reliable and reusable totes are ideal for storage, distribution and order picking. Tops are permanently attached with hinges that interlock for stacking strength and security. Stack for maximized storage and nest when empty. Textured, non-slip bottom ensures smooth conveying. Ergonomically designed handles allow for easy lifting. Recessed lids ensure maximum load stability. Padlock eye provides security option allowing lids to be fastened and/or locked. Molded from high density, FDA approved polyethylene. Lids close securely to protect parts from dust or damage.

Available in: ● Gray ● Custom

MODEL NO.	OUTSIDE DIMENSIONS		INSIDE DIMENSIONS		CONTAINER HEIGHT	VOLUME (CU FT)	CAPACITY GAL	STACK CAP/ QTY STACKED	SHIP WGT
	TOP L" x W"	BOTTOM L" x W"	TOP L" x W"	BOTTOM L" x W"					
QDC2012-7	19-5/8" x 11-9/16"	17" x 9-1/4"	17-9/16" x 9-13/16"	16-1/4" x 8-5/8"	7-1/2"	0.50	8.75	45 lbs/7	4 lbs
QDC2115-9	21-3/4" x 14-7/8"	18-15/16" x 13-1/8"	19-5/8" x 14"	18-3/8" x 12-9/8"	9-5/8"	1.27	9.50	65 lbs/5	6 lbs
QDC2115-12	21-3/4" x 15"	18-9/16" x 12-5/8"	19-3/4" x 14"	18" x 12-1/4"	12-3/4"	1.67	12.50	75 lbs/5	7 lbs
QDC2115-17	21-7/8" x 15-1/8"	18-3/8" x 12-7/8"	20" x 14-1/2"	17-7/8" x 12-1/2"	17-1/4"	2.31	17.25	100 lbs/3	8 lbs
QDC2213-12**	22-1/8" x 12-5/8"	18-7/8" x 10-7/8"	19-7/8" x 12"	18-1/2" x 10-1/8"	11-7/8"	1.42	12.25	75 lbs/5	6 lbs
QDC2420-12*	23-7/8" x 19-3/8"	21-1/4" x 17-5/16"	22-1/4" x 18"	20-5/8" x 16-5/8"	12-1/2"	2.44	18.25	85 lbs/5	8 lbs
QDC2717-12	27-5/16" x 16-9/16"	24-1/4" x 14-1/2"	25-1/8" x 15-3/8"	23-3/8" x 13-3/4"	12-1/2"	2.50	18.75	100 lbs/4	8 lbs
QDC2515-14	25-3/8" x 16-1/4"	22-1/4" x 13-1/4"	23-1/8" x 14-1/4"	21-5/8" x 12-5/8"	14-1/8"	2.20	16.50	100 lbs/4	8 lbs
QDC2820-15*	28-1/8" x 20-5/8"	25-3/8" x 18-3/4"	25-7/8" x 19-3/4"	25-1/8" x 18"	15-5/8"	4.00	29.92	100 lbs/4	13 lbs

*Cannot be used on DLY-2415, use with DLY-3018 Dolly **Manufactured with metal hinge

Collapsible Bulk Box



Quantum's Collapsible Bulk Box provides an efficient approach to large volume or large part material handling, storage and transport. Used for heavy loads, components and even food products, these reusable and returnable containers allow you to ship, handle, pick, store and distribute your products while increasing productivity and profitability. Quantum's Collapsible Bulk Box comes in a standard pallet size footprint measuring 48"L x 45"W. It can be collapsed down to a fraction of its full height in seconds. Bulk containers stack perfectly loaded or when folded down to minimize storage space. They are designed to make the shipping of your products faster, safer and less costly while providing greater protection. Two access drop doors are able to lie flush against the container allowing easy loading and unloading. Manufactured from High Density Polyethylene, this tough container provides superior protection for products while being stored or in transit. Welded base provides greater strength while the reinforced fork openings provide easy lifting. Can withstand temperatures between -20° and 250°F. Optional lid available to cover contents inside (Model No: **LID-4845**).

HANDLE, SHIP, DISTRIBUTE, REUSE



Fully expanded Bulk Box measures 48"L x 45"W x 34"H
 (Lid **LID-4845** Sold separately)



Two access drop doors allows easy loading and unloading



Easy opening and collapsing of Bulk Box's side walls



Collapses to 12-3/4"; a fraction of its full height



QBB-4845-34

PERFORMANCE FEATURES:

- Plastic, ergonomic latches for opening and collapsing
- Superior strength with low tare weight
- High return ratio: return 3 collapsed boxes for each bulk box distributed
- 1,800 lb. load capacity for standard usage
- Large, flat labeling area on all four sides

Available in: ● Black

MODEL NO.	L (INCH/MM)	W (INCH/MM)	H (INCH/MM)
QBB-4845-34			
External	48.00 /1219.2	45.00 /1143.0	33.9 /861.1
Internal	44.50 /1130.3	41.50 /1054.1	28.2 /716.0
Usable Interior Height (Fill line)	-	-	27.10 /688.3
Access Drop Door - Cut Out	-	30.00 /762.0	15.95 /405.1
Collapsed Height	-	-	12.76 /324.0
Nested Height	-	-	11.77 /299.0
Stack of 9/Collapsed (Trailer)	-	-	106.93 /2716.1
Fork Tunnel - 48" Side	-	11.00 /279.4	3.40 /86.4
Fork Tunnel - 45" Side	-	11.38 /288.9	3.40 /86.4
Ship wgt. - 118 lbs			



Mobile Frames

MODEL NO.	DIMENSIONS D" x W" x H"	SHIP WGT
Single Sided Mobile Frame		
TTS-18	18" x 38" x 67"	170 lbs
TTS-24	24" x 38" x 67"	174 lbs
Double Sided Mobile Frame		
TTD-30	30" x 38" x 67"	178 lbs
TTD-40	40" x 38" x 67"	184 lbs



TTS-24 Single Sided Mobile Frame



TTD-40 Double Sided Mobile Frame
Shown with 10 TT-CT15 closed trays
(Sold separately)

Single and Double Sided Removable Tray Trucks

All welded construction with 1-1/2" square tubular frame. Slotted 12 gauge channel uprights (slots on 3-1/2" centers). Bolt on casters, 2 swivel and 2 rigid, for ease of replacement and superior cart tracking. Open and closed front trays and tray dividers sold separately.

Removable Trays

MODEL NO.	DIMENSIONS D" x W" x H"	SHIP WGT	TRAY DIVIDER MODEL NO.	QUANTITY OF TRAYS TO FIT MOBILE FRAMES			
				FRAME TTS-18	FRAME TTS-24	FRAME TTD-30	FRAME TTD-40
Open Front Trays							
TT-OT9	9" x 36" x 3"	16 lbs	TT-DIV3	14	14	28	28
TT-OT15	15" x 36" x 6"	28 lbs	TT-DIV6	-	-	-	14
Closed Front Trays							
TT-CT9	9" x 36" x 3"	16 lbs	TT-DIV3	14	14	28	28
TT-CT15	15" x 36" x 6"	28 lbs	TT-DIV6	-	-	-	14



TT-OT15 Open Tray



TT-CT15 Closed Tray

2,000 lb. LOAD CAPACITY



Order this exact unit
TTD-OT15-240
Unit consists of:
1 - double sided frame TTD-40
10 - open front trays TT-OT15
40 - bins QUS240 available in Blue, Green, Ivory, Red, Yellow, Black or Clear



MAGNUM Bin Transport Trucks



All welded construction with 1-1/2" x 3/16" thick angle frame construction. Twin 1-1/4" tubular handles with smooth radius bend. Bolt on polyurethane casters, 2 swivel and 2 rigid, for easy push and pull and superior tracking.

Bins available in: ● Blue ● Green ● Red ● Yellow ● Black (One color per unit)

MODEL NO.	DIMENSIONS D" x W" x H"	NO. OF BINS	BIN DIMENSIONS L" x W" x H"	SHIP WGT
5" x 1-1/4" - Polyurethane Casters - 1,200 lb. Load Capacity				
MTT-1842-543	18" x 42" x 47"	6	19-3/4" x 18-3/8" x 11-7/8"	204 lbs
MTT-3042-743	30" x 42" x 47"	6	29" x 18-3/8" x 11-7/8"	238 lbs
5" x 2" - Polyurethane Casters - 3,000 lb. Load Capacity				
MTT-1860-543	18" x 60" x 47"	9	19-3/4" x 18-3/8" x 11-7/8"	256 lbs
MTT-3060-743	30" x 60" x 47"	9	29" x 18-3/8" x 11-7/8"	290 lbs
MTT-1878-543	18" x 78" x 47"	12	19-3/4" x 18-3/8" x 11-7/8"	332 lbs
MTT-3078-743	30" x 78" x 47"	12	29" x 18-3/8" x 11-7/8"	380 lbs

**CART OFFERS
1,200 lb.
LOAD CAPACITY**



MTT-1842-543
18"D x 42"W x 47"H
6 bins QMS543
19-3/4" L x 18-3/8" W x 11-7/8" H bins



MTT-3060-743
30"D x 60"W x 47"H
9 bins QMS743
29"L x 18-3/8"W x 11-7/8"H bins

MAGNUM

AVAILABLE on pg. 45

**CARTS OFFER
3,000 lb.
LOAD CAPACITY**



MTT-1878-543
30"D x 78"W x 47"H
12 bins QMS543
19-3/4" L x 18-3/8" W x 11-7/8" H bins



PC4026-33
40"L x 26"W x 32-1/2"H

**CARTS OFFER
550 lb.
LOAD CAPACITY**



PFTC4026-33-3
40"L x 26"W x 32-1/2"H



PFTC4026-33-2
40"L x 26"W x 32-1/2"H

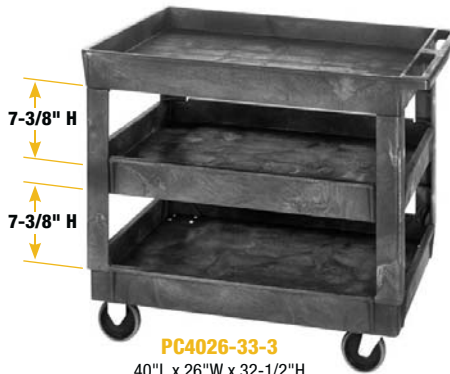

PC4026-33-3
40"L x 26"W x 32-1/2"H



PC3518-33-3
34-1/4"L x 17-1/2"W x 32-1/2"H

Polymer Utility Carts

Industrial strength cart is ideal for many industrial and commercial material handling applications. Set of 2 swivel and 2 rigid 5" x 1-1/4" heavy-duty casters allow for 550 lb. load capacity. Available in two sizes with a 2 or 3 shelf combination.

RUGGED, HEAVY-DUTY, DURABLE

Available in: ● Gray

MODEL NO.	OUTSIDE DIMENSIONS L" x W" x H"	INSIDE SHELF DIMENSIONS L" x W" x H"	NO. OF SHELVES	SHIP WGT
PC3518-33	34-1/4" x 17-1/2" x 32-1/2"	29-1/4" x 15-1/4" x 2-5/8"	2	38 lbs
PC3518-33-3	34-1/4" x 17-1/2" x 32-1/2"	29-1/4" x 15-1/4" x 2-5/8"	3	51 lbs
PC4026-33	40" x 26" x 32-1/2"	35" x 23" x 2-5/8"	2	54 lbs
PC4026-33-3	40" x 26" x 32-1/2"	35" x 23" x 2-5/8"	3	74 lbs
Polymer Flat Top Shelf Cart				
PFTC4026-33-2	40" x 26" x 32-1/2"	35" x 23"*	2	51 lbs
PFTC4026-33-3	40" x 26" x 32-1/2"	35" x 23"*	3	71 lbs
Additional Shelves				
PC3518SHELF	34-1/4" x 17-1/2" x 4-3/16"	29-1/4" x 15-1/4" x 2-5/8"	1	13 lbs
PC4026SHELF	40" x 26" x 4-3/16"	35" x 23" x 2-5/8"	1	20 lbs
Replacement Casters				
PC-CAS-SW	One Replacement Swivel Caster		2	lbs
PC-CAS-RG	One Replacement Rigid Caster		2	lbs

*Inside dimension for middle and bottom shelf 35" x 23" x 2-5/8"

Tool Rack

Space saving Tool Rack is manufactured from durable polypropylene. Get organized with this tough rack that will not warp or bend even when it is loaded to capacity. Holds up to 96 items. Mounting hardware is not included.

Available in: ● Red

MODEL NO.	OUTSIDE DIMENSIONS L" x W" x H"	CTN QTY	CTN WGT
TR-96	6" x 24-1/8" x 2-3/4"	12	9 lbs

Shown with optional Tool Holder Attachment



PC3518-33 + PCTH
34-1/4"L x 17-1/2"W x 32-1/2"H
Shown with optional Tool Holder
(Tools not included)

Plastic Cart Tool Holder Attachment

Available in: ● Red and Gray

MODEL NO.	DESCRIPTION	SHIP WGT
PCTH	96 Piece Tool Holder and Cart Attachment	3 lbs

Patent Pending





Tool Caddy



Industrial strength, hand-held caddy ideal for tools and supplies. This portable, high density polypropylene caddy has extra strength ribs for support. Deep compartments make transporting tools, supplies and loose parts super easy.

Available in: ● Blue ● Gray

MODEL NO.	OUTSIDE DIMENSIONS L" x W" x H"	CTN QTY	CTN WGT
TC-500	13-3/8" x 18-1/4" x 5-1/2"*	6	14 lbs

*Overall height including handle is 9-1/8"



TC-500



Industrial-strength polypropylene



Comfortable grip handle even when carrying heavy loads 9-1/8"H

RUGGED, HEAVY-DUTY, DURABLE

Deep compartments are ideal for automotive parts, hardware or cleaning supplies. Inside pockets measures 16-3/4"L x 4-1/2"W

Perfect for tools, parts and janitorial supplies

Tool Box



This tough Tool Box will not warp or bend even when it is loaded to capacity. Ideal for carrying hand tools, hardware or small to medium sized items. Handle provides comfortable smooth grip. Flush top surface for convenient stacking and storing. Manufactured from heavy-duty polypropylene.

Available in: ● Red ● Clear

MODEL NO.	OUTSIDE DIMENSIONS L" x W" x H"	CTN QTY	CTN WGT
TB12	5-1/2" x 12" x 4-1/8"	12	9 lbs
TB12CL NEW	5-1/2" x 12" x 4-1/8"	12	9 lbs



TB12CL

NEW CLEAR COLOR



TB12

IDEAL FOR CARRYING HAND TOOLS

TOUGH, DURABLE, LOW COST



NPB1076

NEW

Economy All-Purpose Nesting Parts Bin



Organize your small to medium parts with our tough, durable, high density Nesting Parts Bins. Bins save space and nest when empty. Manufactured from heavy-duty polypropylene.

Available in: ○ White ● Black

MODEL NO.	OUTSIDE DIMENSIONS L" x W" x H"	INSIDE BOTTOM DIMENSIONS L" x W" x H"	CTN QTY	CTN WGT
NPB1076 NEW	10-1/4" x 7-1/2" x 6"	8" x 5-1/2" x 5-3/4"	20	10 lbs

Inside top width: 6-1/2" Inside height to open hopper front: 3-3/4"

HEAVY-DUTY INDUSTRIAL-STRENGTH PLASTIC

Wrench Holder



Versatile Wrench Holder can be mounted on any wall surface. Manufactured from high impact polystyrene and can hold up to 15 wrenches of different sizes. Mounting hardware is not included.

Available in: ● Black

MODEL NO.	OUTSIDE DIMENSIONS L" x W" x H"	CTN QTY	CTN WGT
WH-15	1" x 7-1/8" x 11-5/8"	12	5 lbs



WH-15 (Wrenches not included)



Bin, Tote and Container Labels



Labels facilitate parts identification and bar coding of the bin contents. Label sizes and availability vary per product. Correct labeling option(s) are specified alongside products details shown throughout the catalog.

INSERTS INCLUDED

Clear Label Holders and Inserts

Clear Label Holders easily slide into molded-in label slot on bin to protect label. Laser and inkjet compatible inserts come in 8-1/2" x 11" perforated sheets. Each package includes 25 clear holders and corresponding printer friendly sheet labels.

6 MODELS AVAILABLE

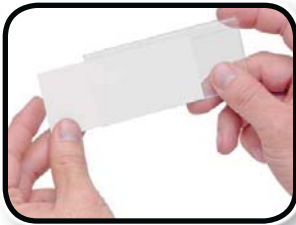

LTR-700, LTR-0813, LTR-1253, LTR-1300, LTR-1754, LTR-2400

Adhesive Label Holders and Inserts

Adhesive Label Holders are designed to work with bins without molded-in label slots. These label holders will attach securely to a flat surface. Laser and inkjet compatible inserts come in 8-1/2" x 11" perforated sheets. Each package includes 24 adhesive holders and corresponding printer friendly sheet labels.



AL-23



AL-35

Bin Rear Label Holder

New Rear Bin Label Holder clips to the back portion of any plastic bin. Creates a vertical extension for a 1" x 3" label or barcode making it easy to identify the contents of that bin. Each package includes 12 clear holders and corresponding printer friendly sheet labels.



RLH1X3C

INSERTS NOT INCLUDED

Label Holders for Dividable Grid Containers

Label Holders are available for standard and conductive dividable grid containers. Three sizes to choose from (2" x 8", 3" x 5" and 5" x 8"). Package of 6.



CLEAR LABEL HOLDER



CONDUCTIVE LABEL HOLDER

Clear Hanging Label Holder

3" x 5" Clear Hanging Label Holder securely attaches to all sizes of stack and nest totes and cross stack tubs. Label holder can be used on totes and tubs with or without lids for easy part identification. Package of 6.



FITS ALL CROSS STACK TUBS

snh010



FITS ALL stack and nest TOTES

Extended Label Holders

Extended Label Holders are designed to slide into the molded label slot of bins to allow for larger bar code scanning or just larger labels. Label holders fit all 4", 6" and 8" Shelf Bins. Provides a 4" x 2-1/4" flat angled surface. Package of 24.

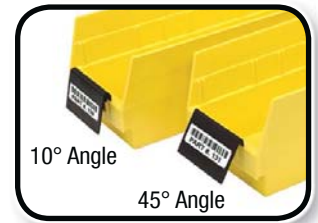

ELH410 and ELH445

Divider Label Tab

Divider Label Tabs attach directly to existing dividers enabling sections of bin to be labeled. Multiple tabs improve the visibility of bin labels and scanning of barcodes. Package of 6.

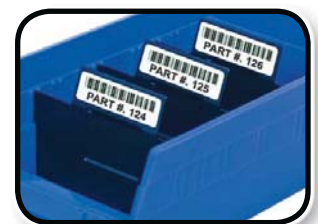

DLT-6



Plastic Drawer Cabinets

- Heavy-duty reinforced construction.
- Each see through drawer includes a divider.
- Stable stacking and easy wall mounting with pre-configured holes on rear side.
- Drawer stops on each drawer prevents spills.
- Textured drawer pull surface.
- Durable high impact polypropylene frame with clear polypropylene drawers and bins.

Available in: ● Black and Gray

MODEL NO.	OUTSIDE DIMENSIONS L" x W" x H"	DRAWER QTY	DRAWER DIMENSIONS L" x W" x H"	PKG QTY	PKG WGT
PDC-12BK <small>NEW</small>	6-1/4" x 10-1/2" x 10-1/4"	8 Drawers	5-1/2" x 2" x 1-1/4"	1	3 lbs
PDC-18BK <small>NEW</small>	6-1/4" x 15" x 18-3/4"	18 Drawers	5-1/2" x 4-1/4" x 2"	1	5 lbs
PDC-22BK <small>NEW</small>	6-1/4" x 19-1/2" x 10"	14 Drawers 8 Drawers	5-1/2" x 2" x 1-1/4" 5-1/2" x 4-1/4" x 2"	1	5 lbs
PDC-39BK <small>NEW</small>	6-1/4" x 15" x 18-3/4"	30 Drawers	5-1/2" x 2" x 1-1/4"	1	6 lbs
PDC-60BK <small>NEW</small>	6-1/4" x 15" x 18-3/4"	9 Drawers	5-1/2" x 4-1/4" x 2"	1	7 lbs
PDC-930BK <small>NEW</small>	6-1/4" x 15" x 18-3/4"	30 Drawers 9 Bins	5-1/2" x 2" x 1-1/4" 5-1/2" x 4-1/4" x 2-3/4"	1	6 lbs



PDC-12BK



PDC-18BK

NEW

EASY TO IDENTIFY ITEMS INSIDE



PDC-22BK



PDC-39BK



PDC-60BK



PDC-930BK



Organizers

Clear lid design allows quick identification of parts inside. Unique latch design enables lid to close and latch tight and secure. Dividers prevent parts from migrating between various compartments. Organizers manufactured from industrial grade polypropylene.

Available in: ● Black, Red and Clear

MODEL NO.	OUTSIDE DIMENSIONS L" x W" x H"	CTN QTY	CTN WGT
Single Sided			
ORG80032	12-1/2" x 10" x 2-1/4"	6	7 lbs
ORG81532 NEW	15" x 12-1/4" x 2-3/4"	6	11 lbs
ORG81832 NEW	18" x 14" x 3"	4	10 lbs
Double Sided			
ORG80322	12-1/4" x 10-1/4" x 3"	5	9 lbs



ORG80032
Single Sided Organizer

- Offers up to 17 storage compartments.
- Includes 12 dividers allowing you to customize the size of the desired compartments inside.

SINGLE SIDED

NEW
SIZES



NEW
ORG81532
Single Sided Organizer

- Offers up to 23 storage compartments.
- Includes 18 dividers allowing you to customize the size of the desired compartments inside.

SINGLE SIDED



NEW
ORG81832
Single Sided Organizer

- Offers up to 26 storage compartments.
- Includes 21 dividers allowing you to customize the size of the desired compartments inside.

SINGLE SIDED



ORG80322
Double Sided Organizer

- Offers up to 32 storage compartments.
- Includes 24 dividers allowing you to customize the size of the desired compartments inside.

DOUBLE SIDED



DIVIDERS INCLUDED

Clear Compartment Storage Boxes

Utility boxes offer compartments for small and medium parts storage. Manufactured of clear, see-through polypropylene.

Available in: Clear

MODEL NO.	OUTSIDE DIMENSIONS L" x W" x H"	CTN QTY	CTN WGT
Removable Dividers			
QB200 <small>NEW</small>	5-1/2" x 2-3/4" x 1-1/4"	12	2 lbs
QB300 <small>NEW</small>	6-3/4" x 4-3/4" x 2-1/4"	12	4 lbs
QB400 <small>NEW</small>	7-3/4" x 5-1/2" x 1-3/4"	12	5 lbs
QB600 <small>NEW</small>	9-1/4" x 6-1/4" x 2-1/5"	6	4 lbs
QB800 <small>NEW</small>	11-3/4" x 7-3/4" x 2-1/5"	6	5 lbs
Fixed Dividers			
QB900	10-1/4" x 13" x 2-3/8"	6	8 lbs



QB900

- Organizer has 10 fixed compartments.



COMPARTMENTS FOR SMALL AND MEDIUM SIZED PARTS

NEW DESIGNS



NEW QB200

- Includes 2 fixed and 6 removable dividers creating 3-8 compartments.



NEW QB300

- Includes 5 removable dividers creating 1-6 compartments.



NEW QB400

- Includes 1 fixed and 6 removable dividers creating 2-8 compartments.



NEW QB600

- Includes removable tray and 3 removable dividers creating 1-8 compartments.



NEW QB800

- Includes 6 removable dividers creating 1-10 compartments.



Environmentally Friendly Recycled Bins



Manufactured from recycled, 100% post consumer, high density polypropylene, these bins come in a complete range of sizes and have all the features of Quantum's standard bins at a more economical price. Available in Black only.

Recycled Ultra Hang & Stack Bins

See pg. 5 for additional information on Ultra Hang & Stack Bins and to order window fronts, clear lids or dividers.



Available in: ●Black

MODEL NO.	OUTSIDE DIMENSIONS L" x W" x H"	CTN QTY	CTN WGT
QUS200BR	5" x 4-1/8" x 3"	24	5 lbs
QUS210BR	5-3/8" x 4-1/8" x 3"	24	6 lbs
QUS220BR	7-3/8" x 4-1/8" x 3"	24	8 lbs
QUS221BR	9-1/4" x 6" x 5"	24	8 lbs
QUS224BR	10-7/8" x 4-1/8" x 4"	12	8 lbs
QUS230BR	10-7/8" x 5-1/2" x 5"	12	10 lbs
QUS232BR	NEW 5-3/8" x 11" x 3"	8	5 lbs
QUS234BR	14-3/4" x 5-1/2" x 5"	12	14 lbs
QUS235BR	10-7/8" x 11" x 5"	6	10 lbs
QUS236BR	NEW 7-3/8" x 11" x 3"	8	9 lbs
QUS238BR	NEW 18" x 5-1/2" x 5"	12	16 lbs
QUS239BR	10-3/4" x 8-1/4" x 7"	6	10 lbs
QUS240BR	14-3/4" x 8-1/4" x 7"	12	24 lbs
QUS241BR	13-5/8" x 8-1/4" x 6"	12	24 lbs
QUS242BR	13-5/8" x 8-1/4" x 8"	12	24 lbs
QUS245BR	10-7/8" x 16-1/2" x 5"	6	13 lbs
QUS248BR	NEW 18" x 8-1/4" x 7"	6	19 lbs
QUS250BR	14-3/4" x 16-1/2" x 7"	6	21 lbs
QUS255BR	16" x 11" x 8"	4	14 lbs
QUS260BR	18" x 11" x 10"	4	17 lbs
QUS265BR	18" x 8-1/4" x 9"	6	17 lbs
QUS270BR	18" x 16-1/2" x 11"	3	16 lbs
QUS275MOBBER	18" x 16-1/2" x 11"	6	19 lbs
QGH700BR	15-1/4" x 19-7/8" x 12-7/16"	3	13 lbs

Recycled Shelf Bins

See pg. 48 for additional information on Shelf Bins and to order dividers and bin cups.

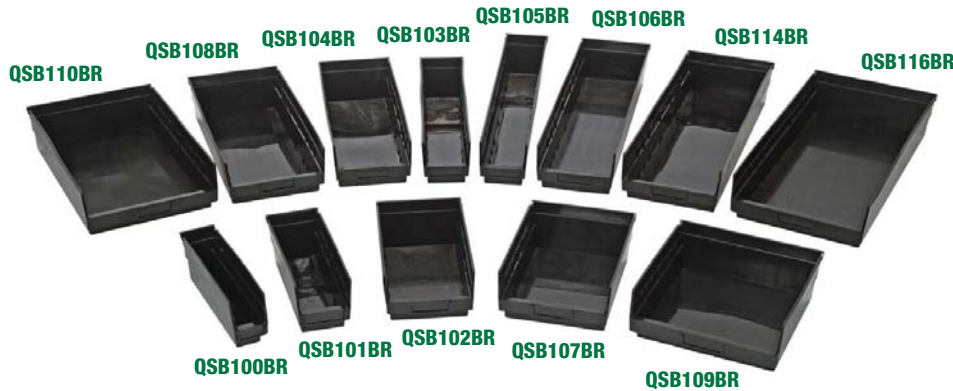

Available in: ●Black

MODEL NO.	OUTSIDE DIMENSIONS L" x W" x H"	CTN QTY	CTN WGT
QSB100BR	11-5/8" x 2-3/4" x 4"	36	13 lbs
QSB101BR	11-5/8" x 4-1/8" x 4"	36	17 lbs
QSB102BR	11-5/8" x 6-5/8" x 4"	30	18 lbs
QSB107BR	11-5/8" x 8-3/8" x 4"	20	15 lbs
QSB109BR	11-5/8" x 11-1/8" x 4"	8	7 lbs
QSB103BR	17-7/8" x 4-1/8" x 4"	20	13 lbs
QSB104BR	17-7/8" x 6-5/8" x 4"	20	16 lbs
QSB108BR	17-7/8" x 8-3/8" x 4"	10	11 lbs
QSB110BR	17-7/8" x 11-1/8" x 4"	8	11 lbs
QSB105BR	23-5/8" x 4-1/8" x 4"	16	13 lbs
QSB106BR	23-5/8" x 6-5/8" x 4"	8	9 lbs
QSB114BR	23-5/8" x 8-3/8" x 4"	6	9 lbs
QSB116BR	23-5/8" x 11-1/8" x 4"	6	10 lbs

Recycled MAGNUM Bins

See pg. 45 for additional information on MAGNUM Bins and to order windows, dividers or a mobile option.



Available in: ●Black

MODEL NO.	OUTSIDE DIMENSIONS L" x W" x H"	CTN QTY	CTN WGT
QMS531BR	19-3/4" x 12-3/8" x 5-7/8"	6	19 lbs
QMS532BR	19-3/4" x 12-3/8" x 7-7/8"	6	23 lbs
QMS533BR	19-3/4" x 12-3/8" x 11-7/8"	3	15 lbs
QMS543BR	19-3/4" x 18-3/8" x 11-7/8"	1	8 lbs
QMS743BR	29" x 18-3/8" x 11-7/8"	1	10 lbs

MANUFACTURED FROM RECYCLED, 100% POST CONSUMER, HIGH DENSITY POLYPROPYLENE



Conductive Ultra Stack Bins & Dividers



Protect your electronic components from typical electromagnetic interference (EMI), electrostatic or induced fields with these conductive polypropylene bins. The conductive material provides a barrier which these fields cannot penetrate and prevents the build-up of an electrostatic charge. Bins are permanently conductive and are unaffected by washing with normal cleaners. Molded from a carbon filled copolymer polypropylene material with an electrostatic decay rate at less than 0.1 second that meets conductivity standards as tested with ASTM-D257 methods. Its surface resistivity is less than 10⁵ Ohms-per square. Easy access to stored items with hopper front bin and label holder provides fast identification. Reinforced side walls and wide ledge allow high stacking on benches or shelving. Be sure all bins are properly grounded according to your use.



Available in: ● Black

MODEL NO.	OUTSIDE DIMENSIONS L" x W" x H"	CTN QTY	CTN WGT	DIVIDER	CTN QTY
QUS200CO	5" x 4-1/8" x 3"	24	5 lbs	DUS200CO	6
QUS210CO	5-3/8" x 4-1/8" x 3"	24	6 lbs	DUS210CO	6
QUS220CO	7-3/8" x 4-1/8" x 3"	24	8 lbs	DUS220CO	6
QUS230CO	10-7/8" x 5-1/2" x 5"	12	12 lbs	DUS230CO	6
QUS235CO	10-7/8" x 11" x 5"	6	10 lbs	DUS235CO	6
QUS239CO	10-3/4" x 8-1/4" x 7"	6	10 lbs	DUS239CO	6
QUS240CO	14-3/4" x 8-1/4" x 7"	12	24 lbs	DUS240CO	6
QUS250CO	14-3/4" x 16-1/2" x 7"	6	21 lbs	DUS250CO	6
QUS255CO	16" x 11" x 8"	4	14 lbs	DUS255CO	6
QUS260CO	18" x 11" x 10"	4	17 lbs	DUS260CO	6
QUS270CO	18" x 16-1/2" x 11"	3	16 lbs	DUS270CO	6

LARGEST

CONDUCTIVE SELECTION AVAILABLE ANYWHERE

CUSTOMIZE YOUR OWN UNIT

1. Select the hanging unit of your choice.
2. Use the chart above and choose the bin that best fits your need.
3. Go to the chart at the bottom of this page and determine how many bins fit on the unit you selected.
4. Place your order for both unit and bins.

Wire Louvered Panels

WALL MOUNT YOUR CONDUCTIVE BINS

Quantum's new chrome Wire Louvered Panels offer a perfect mounting solution for all plastic hanging and new wire mesh hanging bins. Quantum's exclusive offering of wire panels, available in three sizes, completely resist any buildup of dust or dirt. Included direct mounting clips enable fastening to any surface (wall, wood, concrete, drywall, etc.) a snap. Manufactured of heavy-duty chrome wire, Quantum's wire panels will offer years of dependable and heavy-duty service.

GROUND WIRE ALLOWS STATIC CHARGE TO BE DISSIPATED KEEPING BIN CONTENTS SAFE

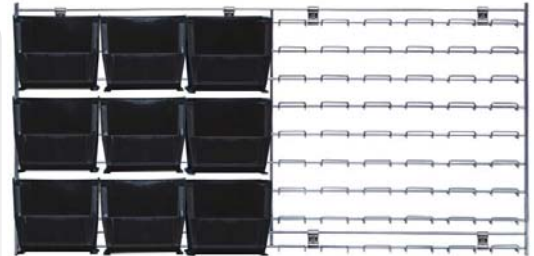

WLP-1836C

36"L x 18"H Includes 8 direct mount clips. 175 lb. load capacity.

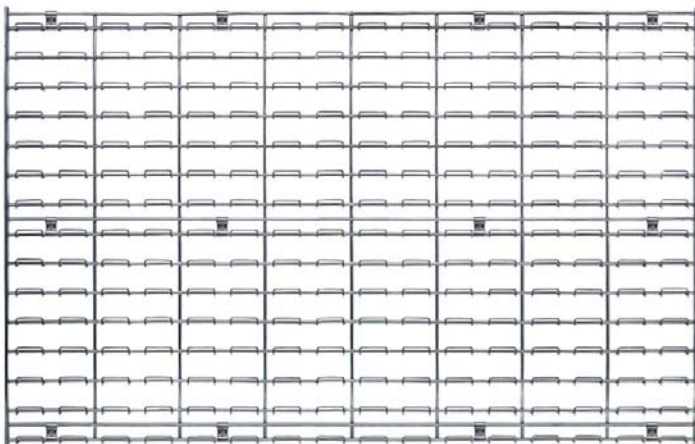

WLP-3048C

48"L x 30"H Includes 12 direct mount clips. 250 lb. load capacity.

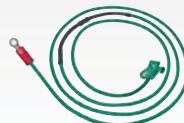

GRD-WR
Ground Wire
(Sold separately)

**SIMPLE TO MOUNT
EASY TO CLEAN
ALL WELDED**

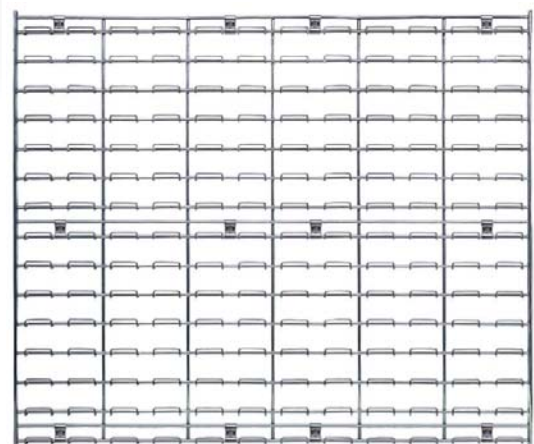

WLP-3036C

36"L x 30"H Includes 12 direct mount clips. 175 lb. load capacity.

QUANTITY OF ULTRA BINS TO FIT LOUVERED PANELS

MODEL NO.	QUS 200CO	QUS 210CO	QUS 220CO	QUS 230CO	QUS 235CO	QUS 239CO	QUS 240CO	QUS 250CO	QUS 255CO	QUS 260CO	QUS 270CO
WLP-1836C	32	32	32	18	9	8	8	4	6	3	2
WLP-3036C	56	56	56	30	15	16	16	6	9	6	6
WLP-3048C	77	77	77	40	20	20	20	8	12	12	6

See chart above for bin dimensions



Conductive Shelf Bins



Protect your electronic components from typical electro-magnetic interference (EMI), electrostatic or induced fields with these molded, carbon-filled, copolymer polypropylene bins. Surface resistivity is less than 10⁵ Ohms-per square. Easy access to stored items with hopper front bin and label holder provides fast identification. The conductive material provides a barrier which these fields cannot penetrate and prevents the build-up of electrostatic charge. Bins are permanently conductive and are unaffected by washing with normal cleaners. Be sure all bins are properly grounded according to your application.

Available in: ● Black

Table with 7 columns: MODEL NO., OUTSIDE DIMENSIONS L" x W" x H", CTN QTY, CTN WGT, DIVIDER, CTN QTY. Lists models QSB100CO through QSB116CO and DSB101CO through DSB116CO.

13 SIZES AVAILABLE



12", 18" AND 24" DEPTHS

Conductive Complete Bin Center

Complete bin systems are available with 4 different size bins on a 12"W x 36"L x 36"H unit. This all-purpose bin center is an economical high density storage system that provides easy visibility to stored contents.

Table with 4 columns: MODEL NO., NO. OF BINS, BIN DIMENSIONS L" x W" x H", SHIP WGT. Lists models WR6-36-1236-101CO through WR6-36-1236-109CO.

CONVERT STANDARD WIRE SHELVING INTO CONDUCTIVE SHELVING WITH THESE ACCESSORIES THAT ARE INCLUDED WITH THESE PACKAGES



ESD-DC Drag Chain



WR-SSCO Plastic Conductive Split Sleeve



800 lb. LOAD CAPACITY PER SHELF

MOBILIZE YOUR WIRE SHELVING

DB - Donut Bumper Non-marking donut bumper used to protect walls and help cushion impact.

WR-00CO (Mobile Kit)* Set of four swivel ESD/Conductive 5" x 1-1/4" casters, two with brakes. Can be used with all units shown. 1,200 lb. load capacity. *Mobile kits recommended only for shelves 18" and deeper.

Conductive Shelf Bin Wire Shelving Systems - Complete Packages

Table with 4 columns: MODEL NO., NO. OF BINS, BIN DIMENSIONS L" x W" x H", SHIP WGT. Lists models WR12-101CO through WR12-116CO.



WR6-36-1236-102CO

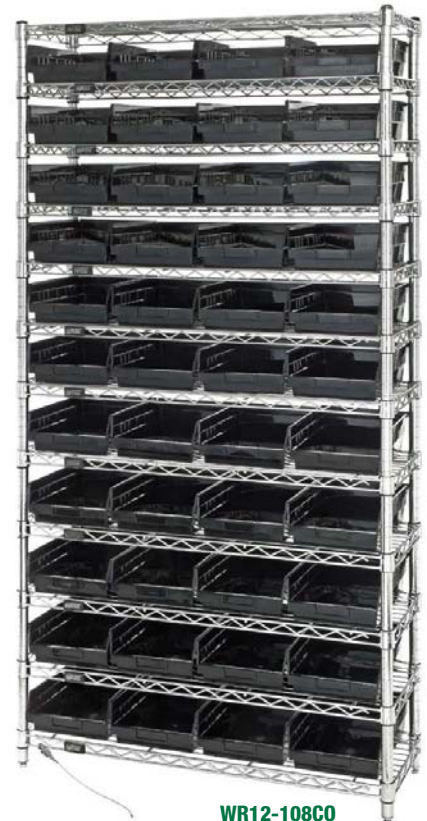

WR12-108CO

11 SIZES AVAILABLE



Conductive Dividable Grid Containers



Protect your electronic components from typical electromagnetic interference (EMI), electrostatic or induced fields with these molded, carbon-filled, copolymer polypropylene dividable grid containers. Surface resistivity is less than 10⁵ Ohms-per square. The conductive material provides a barrier which these fields cannot penetrate and prevents the build-up of electrostatic charge. Containers, dividers and covers are permanently conductive and are unaffected by washing with normal cleaners. Containers have a load capacity of 100 lb. Dividers available to customize your box into compartments at 1-1/8" intervals and snap covers protect contents from dust or damage. Be sure all bins are properly grounded according to your use.

NEW SIZES

Conductive Label Holders

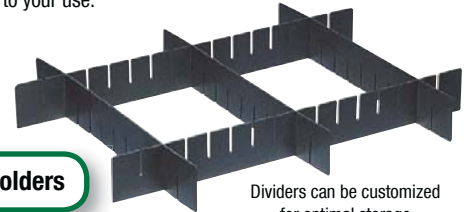

Dividers can be customized for optimal storage (Sold separately)

Available in: ● Black

MODEL NO.	DIMENSIONS H" x W"	FITS BIN MODEL NO.	CTN QTY
LBL2X8CO	2" x 8"	DG91025CO, DG91035CO, DG92035CO, DG93030CO	6
LBL3X5CO	3" x 5"	DG91050CO, DG92050CO, DG92060CO, DG93060CO	6
LBL5X8CO	5" x 8"	DG92080CO, DG93080CO, DG93120CO	6

Available in: ● Black

MODEL NO.	OUTSIDE DIMENSIONS L" x W" x H"	INSIDE DIMENSIONS L" x W" x H"	CTN QTY	CTN WGT	LONG DIVIDER	CTN QTY	SHORT DIVIDER	CTN QTY	COVER	CTN QTY
DG91025CO NEW	10-7/8" x 8-1/4" x 2-1/2"	9-3/16" x 6-9/16" x 2"	20	16 lbs	DL91025CO	6	DS91025CO	6	COV91000CO	10
DG91035CO	10-7/8" x 8-1/4" x 3-1/2"	9-3/16" x 6-9/16" x 3"	20	24 lbs	DL91035CO	6	DS91035CO	6	COV91000CO	10
DG91050CO	10-7/8" x 8-1/4" x 5"	9-3/16" x 6-9/16" x 4-1/2"	20	32 lbs	DL91050CO	6	DS91050CO	6	COV91000CO	10
DG92035CO	16-1/2" x 10-7/8" x 3-1/2"	14-7/8" x 9-1/4" x 3"	12	23 lbs	DL92035CO	6	DS92035CO	6	COV92000CO	4
DG92050CO NEW	16-1/2" x 10-7/8" x 5"	14-7/8" x 9-1/4" x 4-1/2"	12	25 lbs	DL92050CO	6	DS92050CO	6	COV92000CO	4
DG92060CO	16-1/2" x 10-7/8" x 6"	14-7/8" x 9-1/4" x 5-1/2"	8	20 lbs	DL92060CO	6	DS92060CO	6	COV92000CO	4
DG92080CO	16-1/2" x 10-7/8" x 8"	14-7/8" x 9-1/4" x 7-1/2"	8	27 lbs	DL92080CO	6	DS92080CO	6	COV92000CO	4
DG93030CO	22-1/2" x 17-1/2" x 3"	20-5/8" x 15-5/8" x 2-1/2"	6	20 lbs	DL93030CO	6	DS93030CO	6	COV93000CO	3
DG93060CO	22-1/2" x 17-1/2" x 6"	20-5/8" x 15-5/8" x 5-1/2"	3	16 lbs	DL93060CO	6	DS93060CO	6	COV93000CO	3
DG93080CO	22-1/2" x 17-1/2" x 8"	20-5/8" x 15-5/8" x 7-1/2"	3	19 lbs	DL93080CO	6	DS93080CO	6	COV93000CO	3
DG93120CO	22-1/2" x 17-1/2" x 12"	20-5/8" x 15-5/8" x 11-1/2"	3	23 lbs	DL93120CO	6	DS93120CO	6	COV93000CO	3



DIVIDERS

Containers can be divided by length and/or width allowing a subdivision down to a 1-1/8" square compartment size. Available in Black.



SNAP ON COVERS

Snap on covers protect contents from damage or dust during shipping and storage.



LABEL HOLDERS

Fits any size container. Three sizes to choose from. Attach via metal grommets on label holder and bins.



BC212434M1CO

COMPLETE PACKAGES WITH BINS

Conductive Bin Carts

Offering two heights and four bin quantity designs, these modular carts are the ultimate work-in-process and transport carts. Dividable grids slide easily in and out and with their ability to be divided into multiple compartments with long and short dividers, truly any type of storage is possible. Dividable grids are available in Black. **Cart Finish:** Chrome

MODEL NO.	NO. OF BINS	BIN DIMENSIONS L" x W" x H"	SHIP WGT
21"W x 24"L x 45"H - Bin Cart with Dividable Grid Containers			
BC212434M1CO	4	DG93060CO 22-1/2" x 17-1/2" x 6"	58 lbs
BC212439M2CO	7	DG93030CO 22-1/2" x 17-1/2" x 3"	79 lbs
21"W x 24"L x 69"H - Bin Cart with Dividable Grid Containers			
BC212469M1CO	7	DG93060CO 22-1/2" x 17-1/2" x 6"	107 lbs
BC212469M2CO	11	DG93030CO 22-1/2" x 17-1/2" x 3"	111 lbs
21"W x 24"L x 45"H - Bin Cart with No Dividable Grid Containers			
BC212439M4CO	No Containers	(Includes Slides for 4 Bin Levels)	46 lbs
BC212439M7CO	No Containers	(Includes Slides for 7 Bin Levels)	55 lbs
21"W x 24"L x 69"H - Bin Cart with No Dividable Grid Containers			
BC212469MCO	No Containers	(Includes Slides for 7 Bin Levels)	63 lbs
BC212469M11CO	No Containers	(Includes Slides for 11 Bin Levels)	75 lbs



Conductive Wire Utility Carts

Carts consists of 2 u-handles, 4 donut bumpers, 4 conductive swivel casters (2 with brakes), drag chain and 2 or 3 wire shelves.

MODEL NO.	DIMENSIONS W" x L" x H"	SHIP WGT
2 Wire Shelf Mobile Utility Carts		
WRC-1836-2CO	18" x 36" x 37-1/2"	30 lbs
WRC-1842-2CO	18" x 42" x 37-1/2"	32 lbs
WRC-1848-2CO	18" x 48" x 37-1/2"	37 lbs
WRC-2436-2CO	24" x 36" x 37-1/2"	36 lbs
WRC-2442-2CO	24" x 42" x 37-1/2"	40 lbs
WRC-2448-2CO	24" x 48" x 37-1/2"	44 lbs
3 Wire Shelf Mobile Utility Carts		
WRC-1836-3CO	18" x 36" x 37-1/2"	37 lbs
WRC-1842-3CO	18" x 42" x 37-1/2"	42 lbs
WRC-1848-3CO	18" x 48" x 37-1/2"	48 lbs
WRC-2436-3CO	24" x 36" x 37-1/2"	49 lbs
WRC-2442-3CO	24" x 42" x 37-1/2"	55 lbs
WRC-2448-3CO	24" x 48" x 37-1/2"	60 lbs



WRC-1836-2CO

ESD Modular Trays



18" x 26" and 20" x 26" trays are ESD and comply with ANSI/ESD standards for the use in PC board assembly and handling. All trays are manufactured of fiberglass reinforced thermostet material, allowing up to 200 lb. weight capacity when evenly distributed. Quantum's modular trays will withstand temperatures of -40°F to +350°F. Trays are resistant to abrasion and chemicals. Trays are permanently conductive, properties are unaffected by washing in steam or water.

Available in: ● Black

MODEL NO.	DIMENSIONS W" x L" x H"	SHIP WGT
1826ESD	18" x 26" x 1-1/8"	4 lbs
2026ESD	20" x 26" x 1-1/2"	5 lbs



1826ESD



2026ESD

200 lb. LOAD CAPACITY PER TRAY



TC-39CO + 1826ESD
Tray Stops TS62C can be used on back as shown here or one in the back and one in the front. (Trays sold separately)

Conductive Modular Tray Carts

Tray carts are offered in half size and full size units, designed to handle work in process. ESD trays can be used on tray cart for conductive applications with the addition of aluminum split sleeves (ESD-SS) or conductive plastic split sleeves (WR-SSCO) and a drag chain (ESD-DC). Optional Tray Stop prevents trays from falling out. **Cart finish:** Chrome

MODEL NO.	DIMENSIONS W" x L" x H"	CAPACITY	SHIP WGT	TRAY STOP MODEL NO.
39"H - Side Load Tray Cart				
TC-19CO	18" x 30" x 39"	19 Trays	45 lbs	TS32C
69"H - Side Load Tray Carts				
TC-39CO	18" x 30" x 69"	39 Trays	74 lbs	TS62C
TC-31CO	21" x 30" x 69"	31 Trays	68 lbs	TS62C
69"H - End Load Tray Carts				
TC-EL38CO	21-3/4" x 27" x 69"	38 Trays	74 lbs	TS62C

Trays are sold separately

CONVERT STANDARD WIRE SHELVING INTO CONDUCTIVE SHELVING WITH THESE ACCESSORIES THAT ARE INCLUDED WITH THESE PACKAGES



ESD-DC Drag Chain



WR-SSCO Plastic Conductive Split Sleeve



Portable Computer/LAN Work Center

Portable Computer Center and mini LAN (*Local Area Network*) Work Center offers flexibility in any operation. The modular characteristics allow the unit to be adaptable to all your equipment requirements such as servers, PCs, printers, keyboards, and monitors. This system features adjustable shelves on 1" increments, quick field assembly without the use of tools, excellent strength, durable chrome finish and easy to roll locking 3" polyurethane casters. **Finish:** Chrome

- Unit consists of:*
- 4 - 34" posts
 - 3 - 24" x 30" wire shelves
 - 1 - keyboard tray
 - 1 - document holder basket
 - 4 - 3" poly stem casters



M2430CLAN
(computer, monitor, keyboard, printer, folder not included)

Conductive Accessories



WR-SSCO
Conductive Plastic Split Sleeves



ESD-DC
Drag Chain

Reel Shelving Units



Quantum Reel Shelving offers a safe and efficient method of transporting and storing standard size component reels. New reel shelves are chrome plated and can be used in conjunction with same size standard flat wire shelves. Units are available with conductive accessories providing a static safe storage system to address reel handling and providing stationary or mobile complete storage systems for PCB manufacturers. **Finish:** Chrome



NEW
WRC-R264C
(see pg. 111 for additional sizes)

400 lb.
LOAD CAPACITY
PER SHELF



NEW

800 lb.
LOAD CAPACITY
PER SHELF



MOBILIZE YOUR SHELVING

DB - Donut Bumper
Non-marking donut bumper used to protect walls and help cushion impact.

WR-00CO (Mobile Kit)*
Set of four swivel ESD/Conductive 5" x 1-1/4" casters, two with brakes Can be used with all units shown. 1,200 lb. load capacity.
**Mobile kits recommended only for shelves 18" and deeper.*

Stencil Unit



Quantum's new stencil storage racks efficiently and safely store and transport dry stencils. Adjustable shelves and dividers accommodate all frames from 20" to 29" deep. Optional performance cushion ride conductive casters allow built in ESD/conductive protection. Optional side panels available. **Finish:** Chrome

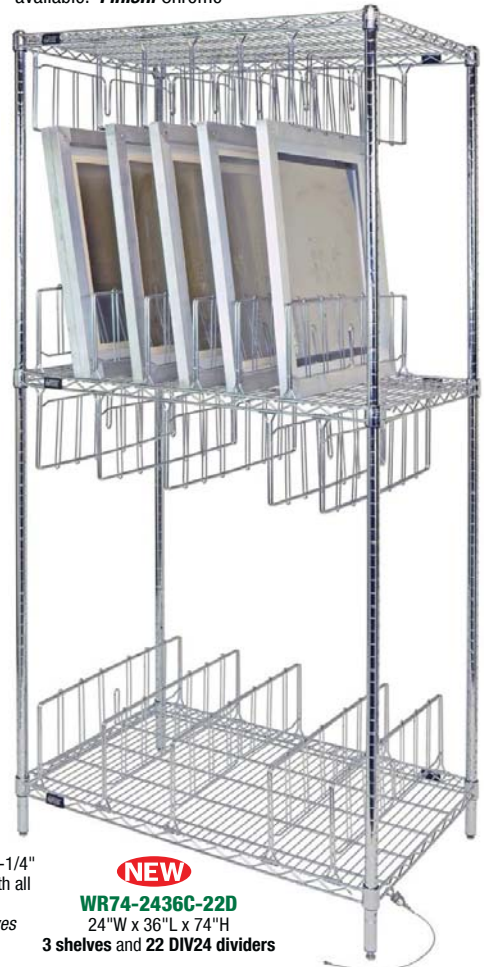

NEW
WR74-2436C-22D
24"W x 36"L x 74"H
3 shelves and 22 DIV24 dividers



Clear Tip Out Bins



THE ORIGINAL AND INDUSTRY STANDARD

Space saving bin units keep small and medium sized parts organized, sorted and easy to find. These clear, break resistant injection molded plastic containers tip open smoothly to a 45° angle and are completely removable for easy access and refilling. Molded handle with slots for labels provided. Bins are easily cleaned with soap and water. Polystyrene cabinet can be stacked or wall mounted. Exterior available in 3 colors. Cups are clear. Optional dividers, locking rod and louvered panel bracket also available.

Available in: ● Ivory ● Gray ○ White

MODEL NO.	OUTSIDE DIMENSIONS L" x W" x H"	CUP DIMENSIONS L" x W" x H"	CTN QTY	CTN WGT
QTB301	11-3/4" x 11-13/16" x 13-7/8"	8-7/8" x 11-1/16" x 13-5/8"	1	7 lbs
QTB302	11-3/4" x 23-5/8" x 13-7/8"	8-7/8" x 11-1/16" x 13-5/8"	1	14 lbs
QTB303	7-3/4" x 23-5/8" x 9-1/2"	5-7/8" x 7-3/8" x 8-5/8"	1	9 lbs
QTB304	6-5/8" x 23-5/8" x 8-1/8"	5" x 5-5/8" x 7-1/2"	1	7 lbs
QTB305	5-1/4" x 23-5/8" x 6-1/2"	3-3/4" x 4-1/4" x 5-3/4"	1	5 lbs
QTB306	3-5/8" x 23-5/8" x 4-1/2"	2-5/8" x 3-1/2" x 3-3/4"	1	2 lbs
QTB309	2-1/2" x 23-5/8" x 3-1/8"	1-3/4" x 2-3/16" x 2-1/2"	1	2 lbs
DIV303	3 Dividers for QTB303		3	2 lbs
DIV304	4 Dividers for QTB304		4	1 lb
QLR500	Locking Rod for 23-5/8"W Tip Out Bins		1	1 lb
QTB-LP-BKT	Louvered Panel Bracket Pair for Tip Out Bins (Sold as a pair)		2	1 lb

TIP OUT BIN CLEAR COMPARTMENTS KEEP SMALL ITEMS SORTED AND EASY TO FIND

QTB309



QTB306



QTB305



QTB304



QTB303



QTB302



QTB-LP-BKT
Louvered Panel Bracket
Hang 23-5/8"W bin on louvered panel using bracket. Available in Beige or Gray. Panels available on pg. 8.



DIV303 and DIV304
QTB303 and QTB304 cup can use optional divider, as shown.



QLR500
Locking Rod
Keeps bins from tilting open. Can be used with 23-5/8"W bins.



QTB309



QTB306



QTB305



QTB304



QTB303



QTB302



QTB301

TIP OUT BIN



CLEAR TIP OUT BIN SYSTEMS CAN BE USED IN ANY APPLICATION



INDUSTRIAL, MECHANICAL AND PLUMBING SUPPLIES

Very handy for the garage, tool shed, service vehicle, factory, hardware and home center facilities.



MEDICAL

Very efficient when it comes to organizing and keeping an effective inventory in hospitals, pharmacies, labs or clinics.



PLAYROOM

The smartest organizer after a hard day's play. It will help keep your child's room in order.

Individual Tip Out Bins



These unique bins have the ability to interlock horizontally or vertically. Available in three popular sizes, these bins allow you to create your own customized Tip Out Bin storage system perfect for color coding.

QTB405 and QTB406 available in: ● Ivory ● Gray ○ White
QTB409 available in: ● Blue ● Red ● Yellow ○ White

MODEL NO.	OUTSIDE DIMENSIONS L" x W" x H"	CTN QTY	CTN WGT
QTB405	5-1/4" x 4-3/4" x 6-1/4"	5	6 lbs
QTB406	3-5/8" x 4-1/16" x 4-1/4"	6	4 lbs
QTB409	2-3/8" x 2-13/16" x 3"	9	3 lbs

BINS INTERLOCK

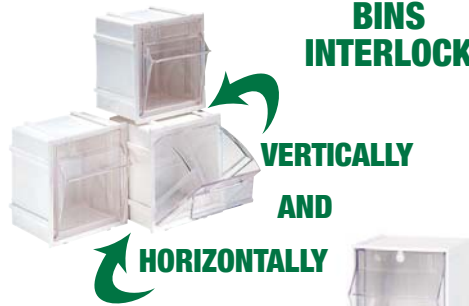

QTB409



QTB406



QTB405

Dividable Tip Out Bins



These bins feature removable and adjustable dividers so that the clear bin can be partitioned into smaller compartments. Ideal for larger or longer items, these clear Tip Out Bins are molded from the same strong and flexible material as our standard bins. The flexibility of bins allow the user to determine the size and volume of each storage compartment. Exterior available in 3 colors. Cups are clear.

Available in: ● Ivory ● Gray ○ White

MODEL NO.	OUTSIDE DIMENSIONS L" x W" x H"	CTN QTY	CTN WGT
QTB410	5-1/4" x 11-7/8" x 5-15/16"	1	3 lbs
QTB411	5-1/4" x 23-5/8" x 5-15/16"	1	4 lbs
QTB412	5-1/4" x 23-5/8" x 5-15/16"	1	4 lbs
DIV400	Divider for Dividable Tip Out Bins	4	1 lb

PERFORMANCE FEATURES:

- Dividable Tip Out Bins are available in 3 sizes (2 with the same width)
- Bins can be stacked as modular units or used individually
- Exterior housing is injection molded from high impact Polystyrene
- Clear bin cups are injection molded from a custom blend of Phillips K Resin and Crystal Styrene for clarity and durability
- Compartments tip open smoothly to a 45° angle and provide comfortable and complete access to stored items
- The flexibility of the system allows you to customize your own system to meet your specific needs



QTB410
 QTB410 is a one bin design, 12" wide
 Each QTB410 comes with 3 DIV400 clear dividers*



QTB411
 QTB411 is a two bin design, each bin 12" wide
 Each QTB411 comes with 6 DIV400 clear dividers*



QTB412
 QTB412 is a one bin design, 23-5/8" wide
 Each QTB412 comes with 5 DIV400 clear dividers*

*Note: Dividers shown in white color for clarity



NEW
 QTB669

21 Compartment Tip Out Bin Set



- 21 clear cups inside one unit
- Clear cups with blue handles

NEW

TIP OUT BIN

Available in: ● Gray

MODEL NO.	OUTSIDE DIMENSIONS L" x W" x H"	CUP DIMENSIONS L" x W" x H"	CUP QTY	PKG QTY	PKG WGT
QTB669	3-5/8" x 23-5/8" x 11-1/6"	2-5/8" x 3-1/2" x 3-3/4" 1-3/4" x 2-3/16" x 2-1/2"	12 9	4	24 lbs



Clear Tip Out Bin Rails

Provide an easy and efficient way to build a high density expandable storage system. U-channel shaped rails allow Tip Out Bins to slide easily to any height. Each Tip Out Bin needs 2 disks and 2 screws (QDS300) in order to affix to all rails and frames. (Bins are sold separately). Powder coat finish.

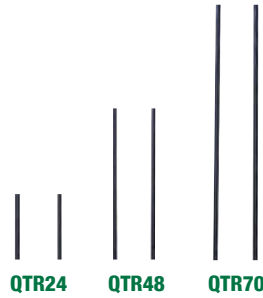

Utilize rails when base of the first bin will sit on the floor

HOW TIP OUT BINS AFFIX TO RAILS AND FRAMES



1 Having removed transparent clear cups, insert screw corresponding to screw holes in Tip Out Bin housing.



2 Insert screws and screw into disk on back of Tip Out Bin housing.



3 Insert disk into frame rails.



4 Once in place, tighten screws to affix Tip Out Bin to frame rails.

Available in: ●Black

MODEL NO.	DESCRIPTION	CTN QTY	CTN WGT	NO. OF BINS TO FIT EACH FRAME					
				QTB 302	QTB 303	QTB 304	QTB 305	QTB 306	QTB 309
QTR24	Two 24"H Rails	1 Set	2 lbs	1	2	3	3	5	8
QTR48	Two 48"H Rails	1 Set	4 lbs	3	5	6	7	10	16
QTR70	Two 70"H Rails	1 Set	5 lbs	5	7	8	10	15	23

Clear Tip Out Bin Frames

Frames are manufactured with preset parallel distance allowing Tip Out Bins to be stacked and removed easily and efficiently. All frames have a ledge at the bottom allowing Tip Out Bins to be secured above ground level. Each Tip Out Bin needs 2 disks and 2 screws (QDS300) in order to affix to all rails and frames. (Bins are sold separately). Powder coat finish.



Utilize frame when bins will be mounted above floor level

Available in: ●Black

MODEL NO.	DESCRIPTION	CTN QTY	CTN WGT	NO. OF BINS TO FIT EACH FRAME					
				QTB 302	QTB 303	QTB 304	QTB 305	QTB 306	QTB 309
QTF24	24"H Frame	1	3 lbs	1	2	3	3	5	8
QTF48	48"H Frame	1	5 lbs	3	5	6	7	10	16
QTF70	70"H Frame	1	7 lbs	5	7	8	10	15	23



QTF320-42
Complete Frame System with Bins

TIP OUT BIN



QDS300
Disk and Screw
(Sold separately)

QLR500
Locking Rod
Keeps bins from tilting open



QTF320
Portable Frame
(Bins sold separately)

Frame and Locking Rod available in: ●Black

MODEL NO.	DESCRIPTION	CTN QTY	CTN WGT
QTF320	24"W x 15"H Portable Frame Only	1	3 lbs
QDS300*	2 Disks and 2 Screws	1 Set	1 lb
QLR500	Locking Rod	1	1 lb
QTF320-42	Complete Frame System with Bins	1	20 lbs

*In order to attach a Tip Out Bin system to a rail, frame or floor stand, 1 set of disks and screws are required per Tip Out Bin system

Clear Tip Out Bin Floor Stands - Single, Double and Mobile
Clearly your best storage solution

Nine pre-configured systems available as pictured allowing you to purchase your Tip Out system exactly as shown here. The flexibility of the system also allows you to customize and create your own configurations (see chart for all possibilities). All steel systems are formed from heavy-duty 14 gauge steel and have a powder coat finish ensuring years of use. Three different heights to choose from: 24", 48" or 70". Systems are single sided, double sided or double sided mobile. Tip Out Bins are available in 3 exterior colors. See pg. 87 for bin dimensions.

SINGLE SIDED
300 lb.
LOAD CAPACITY

- QFS124-31**
 1 QTB304
 3 QTB306
 1 QTB309



- QFS148-38**
 1 QTB302
 1 QTB303
 1 QTB304
 1 QTB305
 1 QTB306
 2 QTB309



- QFS170-36**
 4 QTB303
 2 QTB304
 2 QTB305
 1 QTB306



TIP OUT BIN

COMPLETE PACKAGES WITH BINS

DOUBLE SIDED
600 lb.
LOAD CAPACITY

- QFS224-24**
 2 QTB303
 2 QTB304
 2 QTB305



- QFS248-76**
 2 QTB302
 2 QTB303
 2 QTB304
 2 QTB305
 2 QTB306
 4 QTB309



- QFS270-72**
 8 QTB303
 4 QTB304
 4 QTB305
 2 QTB306





LOWEST PRICE GUARANTEED

CREATE YOUR OWN CUSTOM CONFIGURATION

Mobile Clear Tip Out Bin Floor Stands



wall frames



single sided



double sided



double sided mobile

COMPLETE PACKAGES WITH BINS



QFS224-24 + QFS400
2 QTB303
2 QTB304
2 QTB305

TIP OUT
BIN



QFS270-72 + QFS400
8 QTB303
4 QTB304
4 QTB305
2 QTB306



QFS248-76 + QFS400
2 QTB302
2 QTB303
2 QTB304
2 QTB305
2 QTB306
4 QTB309

MOBILE 500 lb. LOAD CAPACITY

Bins available in: Ivory Gray White

MODEL NO.	DESCRIPTION	DIMENSIONS D" x W" x H"	CTN WGT	QTY. OF BINS TO FIT SYSTEM									
				QTB 302	QTB 303	QTB 304	QTB 305	QTB 306	QTB 309				
Floor Stands - Single Sided (Disks and Screws Required)													
QFS124	24"H Single Sided (Workstation)	10" x 23-5/8" x 28"	11 lbs	1	2	3	3	5	8				
QFS148	48"H Single Sided	10" x 23-5/8" x 52"	19 lbs	3	5	6	7	11	16				
QFS170	70"H Single Sided	10" x 23-5/8" x 75"	20 lbs	5	7	8	10	15	23				
Floor Stands - Double Sided (Disks and Screws Required)													
QFS224	24"H Double Sided (Workstation)	20-1/4" x 23-5/8" x 28"	21 lbs	2	4	6	6	10	16				
QFS248	48"H Double Sided	20-1/4" x 23-5/8" x 52"	36 lbs	6	10	12	14	22	32				
QFS270	70"H Double Sided	20-1/4" x 23-5/8" x 75"	42 lbs	10	14	16	20	30	46				
Mobile Kit (Includes four casters and one handle)													
QFS400*	Mobile Kit for Double Sided Systems		9 lbs	-	-	-	-	-	-				
Disks and Screws													
QDS300	2 Disks and 2 Screws (1 set)		1 lb	-	-	-	-	-	-				

(Tip Out Bins sold separately) 1 set of disks and screws are required per Tip Out Bin system *All mobile units come with four 3" polyurethane casters(all with brakes)



Free Standing Slider Systems - Complete Packages

CONVERT 8' OF STORAGE SPACE INTO JUST 4'

Sliders feature four individual panels filled with tip out bins. Two are fixed to the back side of the system and two slide easily from left to right allowing free access to all four panels. Manufactured of tough 14 gauge steel with a baked enamel finish, the overall unit measures 18"D x 48"W x 77"H or 26"D x 51"W x 77"H. Heavy-duty 2,000 lb. capacity. Bins are available in 3 exterior colors.

TIP OUT BIN

Bins available in: ● Ivory ● Gray ○ White

MODEL NO.	NO. OF BINS	NO. OF BIN CUPS
QS-304-28	28 QTB304	112
QS-305-36	36 QTB305	180
QS-306-56	56 QTB306	336
QS-309-80	80 QTB309	336
QS-305306-52	9 QTB305, 43 QTB306	720
QS-569-56	8 QTB305, 36 QTB306, 12 QTB309	364
QS-BIG-101	3 QTB302, 8 QTB303, 14 QTB304, 3 QTB305	101
QS-000	Free Standing Slider Only - NO BINS	-

*All necessary hardware included with all systems

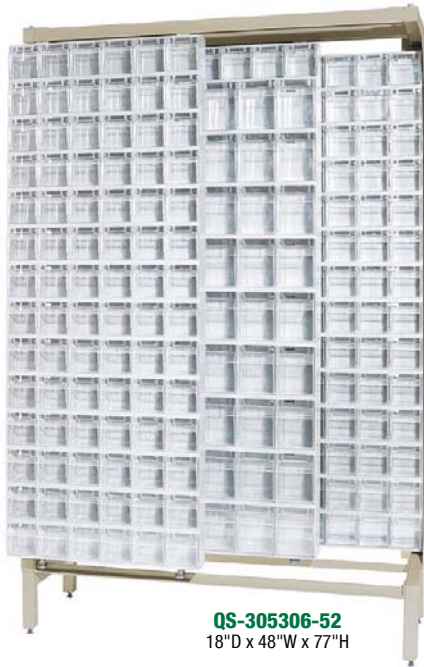

QS-305306-52
18"D x 48"W x 77"H



QS-569-56
18"D x 48"W x 77"H



QS-BIG-101
26"D x 51-1/4"W x 77"H
To be used with QTB302 and QTB303

Gondola Slider Systems - Complete Packages

Gondola systems provide the same versatility for orderly and efficient storage solutions in merchandising, inventory control and storing of small to medium sized parts. Metal slider systems affix heavy-duty 2,000 capacity to most standard gondolas.

Units available for purchase in the following three ways:

- Slider Frame Only (designed for fast installation on your existing 72"H Gondola). **QS-725**
- Slider Frame with Gondola (no Tip Out Bins) Overall Dimensions 19"D x 48"W x 75"H. **G-725**
- Slider Frame filled with Tip Out Bins with Gondola - Complete Package (five available combinations, see chart below).

Bins available in: ● Ivory ● Gray ○ White

MODEL NO.	NO. OF BINS	NO. OF BIN CUPS
QS-725	Slider Frame Only	-
G-725	Slider Frame with Gondola	-
G-725304-28	28 QTB304	112
G-725305-36	36 QTB305	180
G-725306-56	56 QTB306	336
G-725309-80	80 QTB309	720
G-725569-56	8 QTB305, 36 QTB306, 12 QTB309	364

*All necessary hardware included with all systems

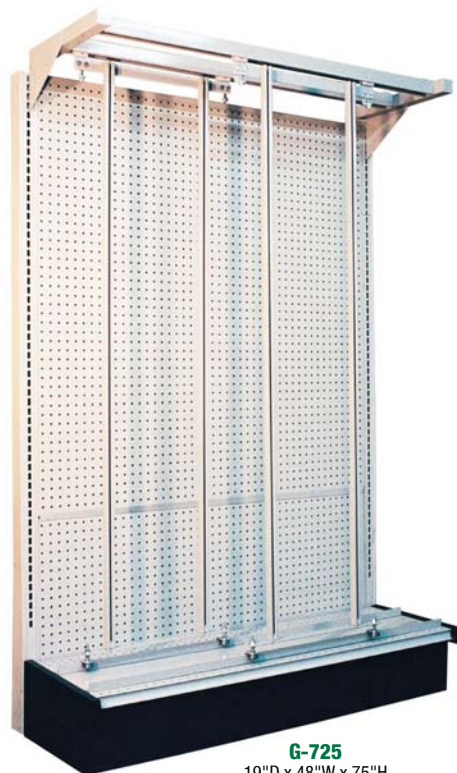

G-725
19"D x 48"W x 75"H

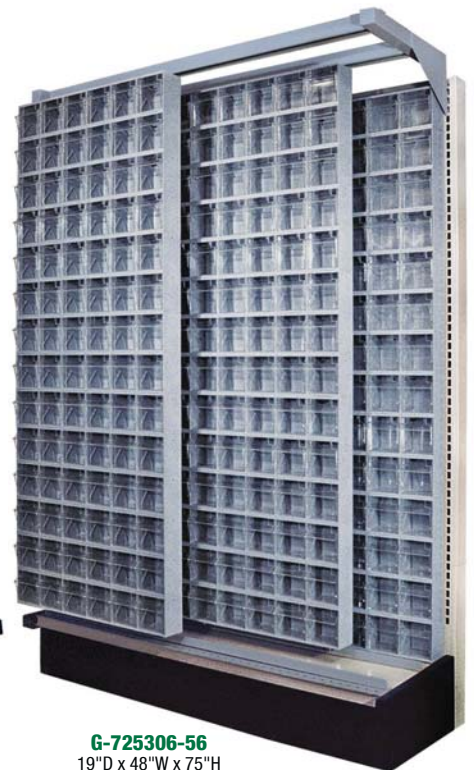

G-725306-56
19"D x 48"W x 75"H



Clear Tip Out Bin Cabinets



NEW

QSC-QTB36-35
Clear Tip Out Bin Small Cabinet
26-1/4"W x 10"D x 36-1/2"H
Total of **35** clear cups. **1 QTB304**, **2 QTB305**,
2 QTB306, **1 QTB309**. Available in Gray.
Ship wt. 84 lbs.



TOP AND BOTTOM HEAVY-DUTY DOOR LOCK

CABINETS AVAILABLE IN GRAY COLOR

Clear Tip Out Bin Cart

TIP OUT ABOUT BIN

COMPLETE PACKAGES WITH BINS

ALL ARRIVE FULLY ASSEMBLED READY TO USE



TBC-32WT
Clear Tip Out Bin Cart
19-1/2"L x 25"W x 41"H
Total of **32** clear cups. **2 QTB305**, **4 QTB304**,
2 QTB303. Comes fully assembled, ready to use.
Available in White. Ship wt. 75 lbs.



NEW

QSC-QTB79-61
Clear Tip Out Bin Tall Cabinet
26-1/4"W x 10"D x 79-1/2"H
Total of **61** clear cups.
3 QTB304, **5 QTB305**, **4 QTB306**.
Available in Gray.
Ship wt. 185 lbs.

- Fully welded strong construction
- Epoxy powder coating
- Metal hinges with 180° opening



COMBINATION LOCK
(Cabinet also comes with master key for combination override)

4 Color Tip Out Bin Spinner

SPINS 360°



PERFECT FOR COLOR CODING YOUR INVENTORY

Clear cups handles come in:

- Blue
- Red
- Yellow
- Green

NEW

QTSPIN148
Clear Tip Out Bin Spinner
37"W x 48"H
700 lb. load capacity. Total of **148** clear cups.
4 QTB304, **12 QTB305**, **12 QTB306**.
Available in Gray with 4 colored sides.
Ship wt. 134 lbs.

Interlocking Storage Cabinets



Organize and store your small parts with these modular storage cabinets. Quantum's interlocking storage cabinets have the unique ability to interlock horizontally and vertically allowing you to customize your storage needs and maximize your storage space. Pre-drilled holes on the rear of cabinet allow for wall mounting. Cabinets are made from high impact polystyrene. Drawers are removable and will not rust or corrode. Drawers have a recessed handle and come with a slotted label holder. Drawers have seven divider slots molded-in so that they may be divided into multiple compartments. Clear window allows easy identification of parts. Nine pre-configured interlocking storage cabinet systems come complete with drawers, clear windows and two dividers per drawer. Additional dividers may be purchased separately. Exterior cabinets are available in Gray only.

Cabinets have the unique ability to interlock horizontally and vertically allowing you to customize your storage needs and maximize your storage space.



Cabinets available in: ● Gray
 Drawers available in: ● Blue ● Red ● Ivory ● Gray

MODEL NO.	DRAWERS PER CABINET	CTN QTY	CTN WGT
QIC-161	16 IDR201	1	10 lbs
QIC-122	12 IDR202	1	10 lbs
QIC-83	8 IDR203	1	9 lbs
QIC-64	6 IDR204	1	9 lbs
QIC-8143	8 IDR201, 4 IDR203	1	10 lbs
QIC-12123	12 IDR201, 2 IDR203	1	10 lbs
QIC-4163	4 IDR201, 6 IDR203	1	10 lbs
QIC-8224	8 IDR202, 2 IDR204	1	10 lbs
QIC-4244	4 IDR202, 4 IDR204	1	10 lbs



CABINET SYSTEMS COME COMPLETE WITH DRAWERS, CLEAR WINDOWS AND TWO DIVIDERS PER DRAWER

QIC-161
 All units measure overall 11-3/8"D x 11-3/4"W x 11"H
 System comes with **16 IDR201**.
 Available with Gray Cabinet and your choice of Gray, Blue, Red and Ivory for drawers.



QIC-122



QIC-83



QIC-64



QIC-8143



QIC-12123



QIC-4163



QIC-8224



QIC-4244

COLOR CODE YOUR SMALL PARTS

Cabinet Drawers



Additional drawers may be purchased separately. All drawers come complete with a clear window. Optional dividers may be purchased separately.

Available in: ● Blue ● Red ● Ivory ● Gray

MODEL NO.	DIMENSIONS L" x W" x H"	CTN QTY	CTN WGT	DIVIDER	CTN QTY	CTN WGT
IDR201	11" x 2-3/4" x 2-1/2"	24	9 lbs	DIV201	25	1 lb
IDR202	11" x 2-3/4" x 3-5/16"	24	12 lbs	DIV202	25	1 lb
IDR203	11" x 5-5/8" x 2-1/2"	24	14 lbs	DIV203	25	1 lb
IDR204	11" x 5-5/8" x 3-5/16"	24	22 lbs	DIV204	25	2 lbs



COMPLETE PACKAGES WITH BINS

Interlocking Storage Cabinet Floor Stands - Single, Double and Mobile

24 pre-configured systems provide an assortment of storage solutions to meet every need. All steel systems are formed from heavy-duty 14 gauge steel and have a smooth powder coat finish ensuring years of use. Three different heights to choose from: 24", 48" or 70". Units are single sided or double sided. Double-sided systems can be made mobile with the addition of the **QFS-400 (mobile kit)** four 3" polyurethane casters all with brakes and 500 lb. capacity. All single sided and double sided systems must be securely fastened to the floor to ensure stability. Interlocking storage cabinet systems come complete with drawers, clear windows and two dividers per drawer. Exterior cabinets are available in Gray only.

**QIC-270-161****384**
drawers**192**
drawers

HIGH DENSITY STORAGE

32
drawers**QIC-124-83****QIC-248-122 + QFS-400**

All mobile units come with four 3" polyurethane casters, all with brakes and 500 lb. capacity

Cabinets available in: ● Gray Drawers available in: ● Blue ● Red ● Ivory ● Gray

COMPLETE STORAGE CABINET FLOOR STANDS

SINGLE SIDED - 300 LB. LOAD CAPACITY				DOUBLE SIDED - 750 LB. LOAD CAPACITY			
MODEL NO.	CABINET PER FLOOR STAND	NO. OF DRAWERS	SHIP WGT	MODEL NO.	CABINET PER FLOOR STAND	NO. OF DRAWERS	SHIP WGT
24"H - Single Sided Floor Stands				24"H - Double Sided Floor Stands			
QIC-124-161	4 QIC-161	64	52 lbs	QIC-224-161	8 QIC-161	128	102 lbs
QIC-124-122	4 QIC-122	48	52 lbs	QIC-224-122	8 QIC-122	96	102 lbs
QIC-124-83	4 QIC-83	32	48 lbs	QIC-224-83	8 QIC-83	64	94 lbs
QIC-124-64	4 QIC-64	24	48 lbs	QIC-224-64	8 QIC-64	48	94 lbs
48"H - Single Sided Floor Stands				48"H - Double Sided Floor Stands			
QIC-148-161	8 QIC-161	128	100 lbs	QIC-248-161	16 QIC-161	256	196 lbs
QIC-148-122	8 QIC-122	96	100 lbs	QIC-248-122	16 QIC-122	192	196 lbs
QIC-148-83	8 QIC-83	64	92 lbs	QIC-248-83	16 QIC-83	128	180 lbs
QIC-148-64	8 QIC-64	48	92 lbs	QIC-248-64	16 QIC-64	96	180 lbs
70"H - Single Sided Floor Stands				70"H - Double Sided Floor Stands			
QIC-170-161	12 QIC-161	192	140 lbs	QIC-270-161	24 QIC-161	384	282 lbs
QIC-170-122	12 QIC-122	144	140 lbs	QIC-270-122	24 QIC-122	288	282 lbs
QIC-170-83	12 QIC-83	96	129 lbs	QIC-270-83	24 QIC-83	192	258 lbs
QIC-170-64	12 QIC-64	72	129 lbs	QIC-270-64	24 QIC-64	144	258 lbs

QFS-400 Kit for mobilizing double sided systems. Includes casters and handle. 500 lb. mobile load capacity.



IRONMAN - Steel Shelving

PERFORMANCE FEATURES:

- Heavy-duty, high grade shelving units are easy to clean and will not rust or corrode
- Shelving Units are 39"H or 75"H and are available in three different shelf sizes
- Shelving has a smooth powder coat finish
- 400 lb. shelf capacity
- Shelves assemble with 4 nuts and bolts per shelf



39-1836-4



75-1836-6

**CLOSED SHELVING
DUST FREE AND SECURE
STORAGE**



CL39-1836-4



CL75-1836-6

MODEL NO.	SHELF D" x W"	SHIP WGT
4 Shelf - 39"H - Open Shelving Unit		
39-1236-4	12" x 36"	45 lbs
39-1836-4	18" x 36"	63 lbs
5 Shelf - 39"H - Open Shelving Unit		
39-1236-5	12" x 36"	53 lbs
39-1836-5	18" x 36"	75 lbs
6 Shelf - 39"H - Open Shelving Unit		
39-1236-6	12" x 36"	61 lbs
39-1836-6	18" x 36"	87 lbs
4 Shelf - 75"H - Open Shelving Unit		
75-1236-4	12" x 36"	55 lbs
75-1836-4	18" x 36"	69 lbs
75-1842-4	18" x 42"	85 lbs
5 Shelf - 75"H - Open Shelving Unit		
75-1236-5	12" x 36"	66 lbs
75-1836-5	18" x 36"	79 lbs
75-1842-5	18" x 42"	91 lbs
6 Shelf - 75"H - Open Shelving Unit		
75-1236-6	12" x 36"	73 lbs
75-1836-6	18" x 36"	89 lbs
75-1842-6	18" x 42"	101 lbs
7 Shelf - 75"H - Open Shelving Unit		
75-1236-7	12" x 36"	80 lbs
75-1836-7	18" x 36"	99 lbs
75-1842-7	18" x 42"	113 lbs
8 Shelf - 75"H - Open Shelving Unit		
75-1236-8	12" x 36"	87 lbs
75-1836-8	18" x 36"	109 lbs
75-1842-8	18" x 42"	125 lbs



MODEL NO.	SHELF D" x W"	SHIP WGT
4 Shelf - 39"H - Closed Shelving Unit		
CL39-1236-4	12" x 36"	71 lbs
CL39-1836-4	18" x 36"	94 lbs
5 Shelf - 39"H - Closed Shelving Unit		
CL39-1236-5	12" x 36"	79 lbs
CL39-1836-5	18" x 36"	106 lbs
6 Shelf - 39"H - Closed Shelving Unit		
CL39-1236-6	12" x 36"	87 lbs
CL39-1836-6	18" x 36"	118 lbs
4 Shelf - 75"H - Closed Shelving Unit		
CL75-1236-4	12" x 36"	90 lbs
CL75-1836-4	18" x 36"	115 lbs
5 Shelf - 75"H - Closed Shelving Unit		
CL75-1236-5	12" x 36"	103 lbs
CL75-1836-5	18" x 36"	126 lbs
6 Shelf - 75"H - Closed Shelving Unit		
CL75-1236-6	12" x 36"	110 lbs
CL75-1836-6	18" x 36"	136 lbs
7 Shelf - 75"H - Closed Shelving Unit		
CL75-1236-7	12" x 36"	117 lbs
CL75-1836-7	18" x 36"	146 lbs
8 Shelf - 75"H - Closed Shelving Unit		
CL75-1236-8	12" x 36"	124 lbs
CL75-1836-8	18" x 36"	156 lbs



Wire Shelving Systems Finishes



6 WIRE FINISHES AVAILABLE

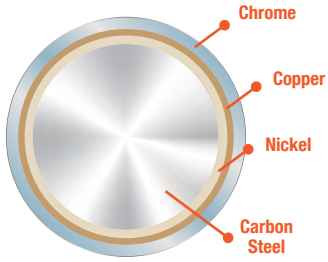

Chrome - is a plating process which deposits hard chrome over a copper, nickel surface. This process is very durable and allows product to be used in any application in a dry storage environment. **1 year limited warranty to not rust or corrode when used in dry and non-humid environments.**

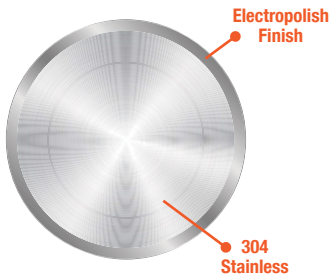
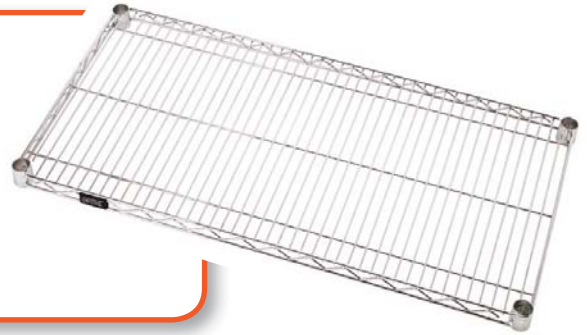

Stainless Steel - 304 Stainless with an electro-polish finish represents the highest industry standard in the prevention of corrosion. This finish is highly effective for corrosive, high humidity or clean room environments. **Lifetime warranty for 304 stainless steel electro-polish finish.**

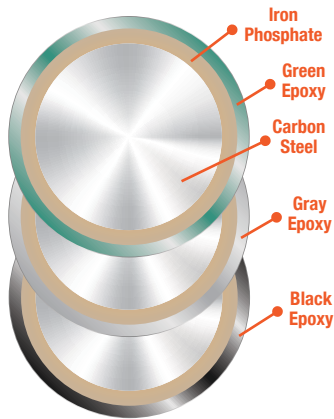
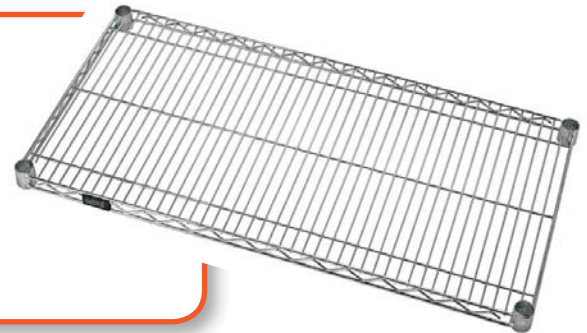

Proform Green, Gray and Black Epoxy - are an ideal solution for high humidity, wet, or walk-in-cooler applications. The carbon steel is treated with an iron phosphate and the powder coated epoxy is electrostatically applied, baked and cured to a hard surface. All three colors are antimicrobial. **15 year limited warranty for antimicrobial finish to not rust or corrode.**

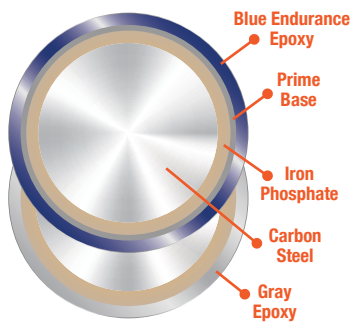
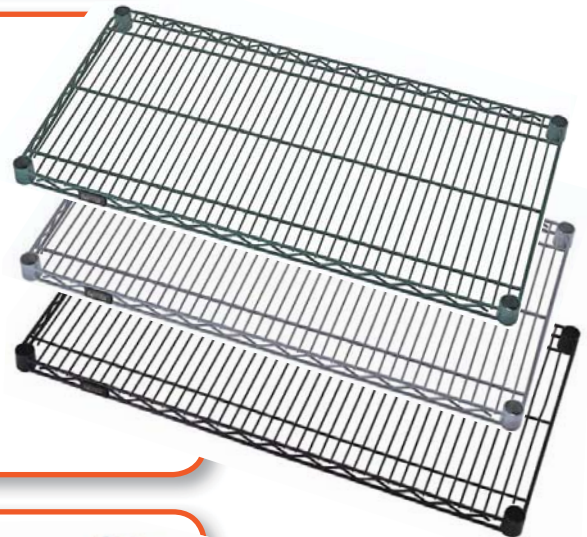

Blue Endurance and Gray Epoxy - is a developed process which exceeds conventional finishes. Finish is excellent for high humidity or corrosive applications and is fortified with an antimicrobial agent. **15 year limited warranty for antimicrobial finish to not rust or corrode.**

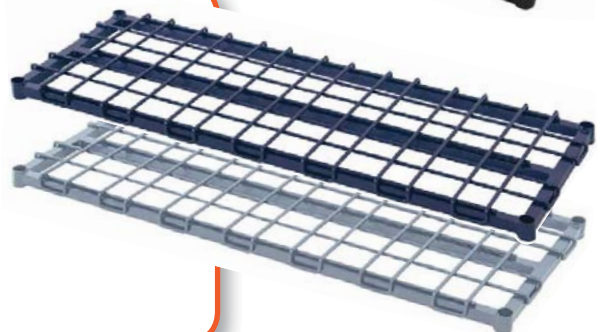

APPLICATION	CHROME FINISH	STAINLESS STEEL FINISH	PROFORM GREEN, GRAY & BLACK EPOXY FINISH	BLUE ENDURANCE FINISH
DRY STORAGE	YES	YES	YES	YES
WET STORAGE	NO	YES	YES	YES
COOLER STORAGE	NO	YES	YES	YES
FREEZER STORAGE	NO	YES	YES	YES
WARRANTY*	1 YEAR DRY	LIFETIME	15 YEAR	15 YEAR

*Limited against rust and corrosion

Wire Shelves NSF

Genuine Quantum modular wire systems offer a unique combination of shelf and post sizes in a variety of finishes to work in any application. The all welded shelf construction is supported with architectural wire trusses to provide between 600 lb. and 1,000 lb. capacity per shelf.



- CHROME
- 304 STAINLESS STEEL
- PROFORM GREEN EPOXY
- **NEW** GRAY EPOXY
- BLACK EPOXY
- GALVANIZED STEEL
- STAINLESS STEEL

600-800 lb.
LOAD CAPACITY PER SHELF

1,000 lb.
LOAD CAPACITY PER HEAVY-DUTY SHELF

SHELF W" x L"	SHIP WGT	CHROME MODEL NO.	STAINLESS STEEL MODEL NO.	EPOXY		
				PROFORM GREEN MODEL NO.	GRAY NEW MODEL NO.	BLACK MODEL NO.
12" Deep - Wire Shelves						
12" x 24"	6 lbs	1224C	-	1224P	1224GY	1224BK
12" x 30"	6 lbs	1230C	-	1230P	1230GY	1230BK
12" x 36"	7 lbs	1236C	1236S	1236P	1236GY	1236BK
12" x 42"	8 lbs	1242C	-	1242P	1242GY	1242BK
12" x 48"	9 lbs	1248C	1248S	1248P	1248GY	1248BK
12" x 60"	14 lbs	1260C	1260S	1260P	1260GY	1260BK
12" x 72"	17 lbs	1272C	1272S	1272P	1272GY	1272BK
14" Deep - Wire Shelves						
14" x 24"	6 lbs	1424C	-	1424P	1424GY	1424BK
14" x 30"	7 lbs	1430C	1430S	1430P	1430GY	1430BK
14" x 36"	8 lbs	1436C	1436S	1436P	1436GY	1436BK
14" x 42"	10 lbs	1442C	1442S	1442P	1442GY	1442BK
14" x 48"	11 lbs	1448C	1448S	1448P	1448GY	1448BK
14" x 54"	12 lbs	1454C	1454S	1454P	1454GY	1454BK
14" x 60"	14 lbs	1460C	1460S	1460P	1460GY	1460BK
14" x 72"	17 lbs	1472C	1472S	1472P	1472GY	1472BK
18" Deep - Wire Shelves						
18" x 24"	7 lbs	1824C	1824S	1824P	1824GY	1824BK
18" x 30"	8 lbs	1830C	1830S	1830P	1830GY	1830BK
18" x 36"	10 lbs	1836C	1836S	1836P	1836GY	1836BK
18" x 42"	11 lbs	1842C	1842S	1842P	1842GY	1842BK
18" x 48"	14 lbs	1848C	1848S	1848P	1848GY	1848BK
18" x 54"	15 lbs	1854C	1854S	1854P	1854GY	1854BK
18" x 60"	17 lbs	1860C	1860S	1860P	1860GY	1860BK
18" x 72"	20 lbs	1872C	1872S	1872P	1872GY	1872BK
21" Deep - Wire Shelves						
21" x 24"	8 lbs	2124C	2124S	2124P	2124GY	2124BK
21" x 30"	9 lbs	2130C	2130S	2130P	2130GY	2130BK
21" x 36"	11 lbs	2136C	2136S	2136P	2136GY	2136BK
21" x 42"	12 lbs	2142C	2142S	2142P	2142GY	2142BK
21" x 48"	14 lbs	2148C	2148S	2148P	2148GY	2148BK
21" x 54"	16 lbs	2154C	2154S	2154P	2154GY	2154BK
21" x 60"	18 lbs	2160C	2160S	2160P	2160GY	2160BK
21" x 72"	24 lbs	2172C	2172S	2172P	2172GY	2172BK
24" Deep - Wire Shelves						
24" x 24"	9 lbs	2424C	2424S	2424P	2424GY	2424BK
24" x 30"	11 lbs	2430C	2430S	2430P	2430GY	2430BK
24" x 36"	13 lbs	2436C	2436S	2436P	2436GY	2436BK
24" x 42"	15 lbs	2442C	2442S	2442P	2442GY	2442BK
24" x 48"	16 lbs	2448C	2448S	2448P	2448GY	2448BK
24" x 54"	18 lbs	2454C	2454S	2454P	2454GY	2454BK
24" x 60"	21 lbs	2460C	2460S	2460P	2460GY	2460BK
24" x 66"	23 lbs	2466C	-	2466P	2466GY	-
24" x 72"	26 lbs	2472C	2472S	2472P	2472GY	2472BK
24" Deep Heavy-Duty - Wire Shelves (1,000 lb. capacity)						
24" x 60"	25 lbs	2460CHD	-	-	-	-
24" x 72"	30 lbs	2472CHD	-	-	-	-
30" Deep - Wire Shelves						
30" x 36"	15 lbs	3036C	3036S	3036P	3036GY	3036BK
30" x 42"	18 lbs	3042C	3042S	3042P	3042GY	3042BK
30" x 48"	21 lbs	3048C	3048S	3048P	3048GY	3048BK
30" x 60"	27 lbs	3060C	3060S	3060P	3060GY	3060BK
30" x 72"	31 lbs	3072C	3072S	3072P	3072GY	3072BK
36" Deep - Wire Shelves						
36" x 36"	18 lbs	3636C	3636S	3636P	3636GY	3636BK
36" x 48"	23 lbs	3648C	3648S	3648P	3648GY	3648BK
36" x 60"	29 lbs	3660C	3660S	3660P	3660GY	3660BK
36" x 72"	35 lbs	3672C	3672S	3672P	3672GY	3672BK

PERFORMANCE FEATURES:

- All welded construction with additional wire trussing for high strength characteristics
- Top mat wires run front to back (except on 12" x 36" size) for ease of loading and unloading and superior strength
- Wire allows air to circulate and light to penetrate for increased product visibility
- Minimal dirt accumulation
- Split sleeve connectors secure shelf corners to posts
- Numbered grooved posts on 1 inch increments for quick assembly
- No tools required for assembly
- Adjustable foot levelers allow for perfect stability
- Durable finishes
- Aesthetically pleasing
- Optional accessories (see pgs. 146-148)
- National Sanitation Foundation (NSF) Approved
- Shipped KD Class 70
- 600 to 1,000 lb. capacity per shelf



Posts



NEW GRAY FINISH

DESCRIPTION	SHIP WGT	CHROME	STAINLESS STEEL	EPOXY		
		MODEL NO.	MODEL NO.	PROFORM GREEN	GRAY NEW	BLACK
				MODEL NO.	MODEL NO.	MODEL NO.
6"H Post	1 lb	P6C	P6S	P6P	P6GY	P6BK
14"H Post	1 lb	P14C	P14S	P14P	P14GY	P14BK
34"H Post	2 lbs	P34C	P34S	P34P	P34GY	P34BK
36"H Post	2 lbs	P36C	-	-	-	-
39"H Post	2 lbs	P39C	-	-	-	P39BK
42"H Post	2 lbs	-	P42S	-	-	-
54"H Post	3 lbs	P54C	P54S	P54P	P54GY	P54BK
63"H Post	4 lbs	P63C*	P63S	P63P*	P63GY*	P63BK*
74"H Post	4 lbs	P74C*	P74S	P74P*	P74GY*	P74BK*
86"H Post	5 lbs	P86C*	P86S	P86P*	P86GY*	P86BK*
96"H Post	6 lbs	P96C	P96S	P96P	P96GY	P96BK

*For easy installation, 63", 74" and 86" posts are available with pre-inserted leveler and bolt by adding an X to the Model No. P74CX

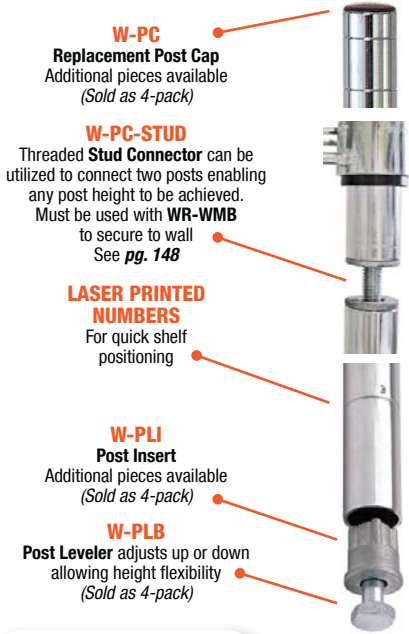

W-PC
Replacement Post Cap
Additional pieces available
(Sold as 4-pack)

W-PC-STUD
Threaded Stud Connector can be utilized to connect two posts enabling any post height to be achieved. Must be used with **WR-WMB** to secure to wall See **pg. 148**

LASER PRINTED NUMBERS
For quick shelf positioning

W-PLI
Post Insert
Additional pieces available
(Sold as 4-pack)

W-PLB
Post Leveler adjusts up or down allowing height flexibility
(Sold as 4-pack)

Posts Label Holders

NEW

New post label holders come in two sizes and allow for easy identification of aisles/rows as well as of wire cart contents. Attach to standard 1" diameter posts. Each package includes 12 clear holders and corresponding printer friendly sheet labels.

MODEL NO.	DIMENSIONS W" x L"	SHIP WGT
PLH1X6C	1" x 6"	1 lb
PLH2X4C	2" x 4"	1 lb



400-600 lb.
LOAD CAPACITY PER SHELF

Solid Shelves



- Designed for storage of small parts that might normally fall through wire shelves
- Dual layer construction with double hemmed perimeter with marine edge ensures maximum strength while retaining spillage and excellent corrosion resistance

18 GAUGE GALVANIZED
304 STAINLESS STEEL



DIMENSIONS W" x L"	SHIP WGT	GALVANIZED STEEL	STAINLESS STEEL
		MODEL NO.	MODEL NO.
14" Deep - Solid Shelves			
14" x 36"	14 lbs	1436SG	1436SS
14" x 42"	15 lbs	1442SG	1442SS
14" x 48"	17 lbs	1448SG	1448SS
14" x 54"	20 lbs	1454SG	1454SS
14" x 60"	22 lbs	1460SG	1460SS
14" x 72"	26 lbs	1472SG	1472SS
18" Deep - Solid Shelves			
18" x 24"	11 lbs	1824SG	1824SS
18" x 30"	14 lbs	1830SG	1830SS
18" x 36"	16 lbs	1836SG	1836SS
18" x 42"	18 lbs	1842SG	1842SS
18" x 48"	20 lbs	1848SG	1848SS
18" x 54"	22 lbs	1854SG	1854SS
18" x 60"	24 lbs	1860SG	1860SS
18" x 72"	27 lbs	1872SG	1872SS
21" Deep - Solid Shelves			
21" x 24"	13 lbs	2124SG	2124SS
21" x 30"	15 lbs	2130SG	2130SS
21" x 36"	18 lbs	2136SG	2136SS
21" x 42"	21 lbs	2142SG	2142SS
21" x 48"	23 lbs	2148SG	2148SS
21" x 54"	25 lbs	2154SG	2154SS
21" x 60"	28 lbs	2160SG	2160SS
21" x 72"	30 lbs	2172SG	2172SS
24" Deep - Solid Shelves			
24" x 24"	15 lbs	2424SG	2424SS
24" x 30"	17 lbs	2430SG	2430SS
24" x 36"	19 lbs	2436SG	2436SS
24" x 42"	22 lbs	2442SG	2442SS
24" x 48"	24 lbs	2448SG	2448SS
24" x 54"	26 lbs	2454SG	2454SS
24" x 60"	31 lbs	2460SG	2460SS
24" x 72"	34 lbs	2472SG	2472SS

ASSEMBLING WIRE SHELVING UNITS IS AS EASY AS 1 - 2 - 3...



1 Snap plastic sleeve around post.



2 Slide shelf over sleeve for secure locking.



3 Two "S-Hooks" are used to connect add-on wire shelf to starter units.



Starter Kits



Heavy-duty shelving units allow up to 800 lb. shelf capacity. Starter kits come complete with 4 posts and 4 or 5 shelves. Additional shelves may be purchased separately. See chart on **pg. 98**. Mobilize starter kit shelving unit using optional mobile kit, **WR-00H**, see **pg. 149**. **Finishes:** Chrome, Stainless Steel, Proform Green, Gray, Black Epoxy

600-800 lb. LOAD CAPACITY PER SHELF

TO CHOOSE FINISH ADD FINISH SUFFIX TO MODEL NO.

- Ex: **Chrome** WR54-1236C
Stainless WR54-1236S
Proform Green WR54-1236P
Gray WR54-1236GY
Black WR54-1236BK

- Ex: **Chrome** WR54-1236C-5
Stainless WR54-1236S-5
Proform Green WR54-1236P-5
Gray WR54-1236GY-5
Black WR54-1236BK-5

- Chrome** S
Stainless N
Proform Green Y
GY Gray
BK Black

54" H - WIRE SHELVING 4 SHELVES				54" H - WIRE SHELVING 5 SHELVES				AVAILABLE FINISHES	
STARTER KIT		ADD-ON KIT		STARTER KIT		ADD-ON KIT			
SHELF W" x L"	MODEL NO.	SHIP WGT	MODEL NO.	SHIP WGT	MODEL NO.	SHIP WGT	MODEL NO.	SHIP WGT	C S P G Y BK
12" x 36"	WR54-1236	40 lbs	AD54-1236	36 lbs	WR54-1236-5	47 lbs	AD54-1236-5	45 lbs	Y Y Y Y Y
12" x 42"	WR54-1242	44 lbs	AD54-1242	40 lbs	WR54-1242-5	52 lbs	AD54-1242-5	50 lbs	Y N Y Y Y
12" x 48"	WR54-1248	48 lbs	AD54-1248	44 lbs	WR54-1248-5	57 lbs	AD54-1248-5	55 lbs	Y Y Y Y Y
12" x 60"	WR54-1260	56 lbs	AD54-1260	52 lbs	WR54-1260-5	70 lbs	AD54-1260-5	68 lbs	Y Y Y Y Y
12" x 72"	WR54-1272	64 lbs	AD54-1272	60 lbs	WR54-1272-5	81 lbs	AD54-1272-5	79 lbs	Y Y Y Y Y
14" x 24"	WR54-1424	36 lbs	AD54-1424	32 lbs	WR54-1424-5	42 lbs	AD54-1424-5	40 lbs	Y N Y Y Y
14" x 30"	WR54-1430	40 lbs	AD54-1430	36 lbs	WR54-1430-5	47 lbs	AD54-1430-5	45 lbs	Y Y Y Y Y
14" x 36"	WR54-1436	44 lbs	AD54-1436	40 lbs	WR54-1436-5	52 lbs	AD54-1436-5	50 lbs	Y Y Y Y Y
14" x 42"	WR54-1442	52 lbs	AD54-1442	48 lbs	WR54-1442-5	62 lbs	AD54-1442-5	60 lbs	Y Y Y Y Y
14" x 48"	WR54-1448	56 lbs	AD54-1448	52 lbs	WR54-1448-5	67 lbs	AD54-1448-5	65 lbs	Y Y Y Y Y
14" x 54"	WR54-1454	60 lbs	AD54-1454	56 lbs	WR54-1454-5	72 lbs	AD54-1454-5	70 lbs	Y Y Y Y Y
14" x 60"	WR54-1460	68 lbs	AD54-1460	64 lbs	WR54-1460-5	82 lbs	AD54-1460-5	80 lbs	Y Y Y Y Y
14" x 72"	WR54-1472	80 lbs	AD54-1472	76 lbs	WR54-1472-5	97 lbs	AD54-1472-5	95 lbs	Y Y Y Y Y
18" x 24"	WR54-1824	40 lbs	AD54-1824	36 lbs	WR54-1824-5	47 lbs	AD54-1824-5	45 lbs	Y Y Y Y Y
18" x 30"	WR54-1830	44 lbs	AD54-1830	40 lbs	WR54-1830-5	52 lbs	AD54-1830-5	50 lbs	Y Y Y Y Y
18" x 36"	WR54-1836	52 lbs	AD54-1836	48 lbs	WR54-1836-5	62 lbs	AD54-1836-5	60 lbs	Y Y Y Y Y
18" x 42"	WR54-1842	56 lbs	AD54-1842	52 lbs	WR54-1842-5	67 lbs	AD54-1842-5	65 lbs	Y Y Y Y Y
18" x 48"	WR54-1848	60 lbs	AD54-1848	56 lbs	WR54-1848-5	74 lbs	AD54-1848-5	72 lbs	Y Y Y Y Y
18" x 54"	WR54-1854	72 lbs	AD54-1854	68 lbs	WR54-1854-5	87 lbs	AD54-1854-5	81 lbs	Y Y Y Y Y
18" x 60"	WR54-1860	80 lbs	AD54-1860	76 lbs	WR54-1860-5	97 lbs	AD54-1860-5	95 lbs	Y Y Y Y Y
18" x 72"	WR54-1872	92 lbs	AD54-1872	88 lbs	WR54-1872-5	112 lbs	AD54-1872-5	108 lbs	Y Y Y Y Y
21" x 24"	WR54-2124	44 lbs	AD54-2124	40 lbs	WR54-2124-5	52 lbs	AD54-2124-5	50 lbs	Y Y Y Y Y
21" x 30"	WR54-2130	48 lbs	AD54-2130	44 lbs	WR54-2130-5	57 lbs	AD54-2130-5	55 lbs	Y Y Y Y Y
21" x 36"	WR54-2136	56 lbs	AD54-2136	52 lbs	WR54-2136-5	67 lbs	AD54-2136-5	65 lbs	Y Y Y Y Y
21" x 42"	WR54-2142	60 lbs	AD54-2142	56 lbs	WR54-2142-5	72 lbs	AD54-2142-5	70 lbs	Y Y Y Y Y
21" x 48"	WR54-2148	68 lbs	AD54-2148	64 lbs	WR54-2148-5	82 lbs	AD54-2148-5	84 lbs	Y Y Y Y Y
21" x 54"	WR54-2154	76 lbs	AD54-2154	72 lbs	WR54-2154-5	92 lbs	AD54-2154-5	94 lbs	Y Y Y Y Y
21" x 60"	WR54-2160	84 lbs	AD54-2160	80 lbs	WR54-2160-5	102 lbs	AD54-2160-5	108 lbs	Y Y Y Y Y
21" x 72"	WR54-2172	108 lbs	AD54-2172	104 lbs	WR54-2172-5	132 lbs	AD54-2172-5	130 lbs	Y Y Y Y Y
24" x 24"	WR54-2424	48 lbs	AD54-2424	44 lbs	WR54-2424-5	57 lbs	AD54-2424-5	55 lbs	Y Y Y Y Y
24" x 30"	WR54-2430	56 lbs	AD54-2430	52 lbs	WR54-2430-5	67 lbs	AD54-2430-5	65 lbs	Y Y Y Y Y
24" x 36"	WR54-2436	64 lbs	AD54-2436	60 lbs	WR54-2436-5	77 lbs	AD54-2436-5	75 lbs	Y Y Y Y Y
24" x 42"	WR54-2442	72 lbs	AD54-2442	68 lbs	WR54-2442-5	87 lbs	AD54-2442-5	85 lbs	Y Y Y Y Y
24" x 48"	WR54-2448	76 lbs	AD54-2448	72 lbs	WR54-2448-5	92 lbs	AD54-2448-5	90 lbs	Y Y Y Y Y
24" x 54"	WR54-2454	84 lbs	AD54-2454	80 lbs	WR54-2454-5	102 lbs	AD54-2454-5	100 lbs	Y Y Y Y Y
24" x 60"	WR54-2460	96 lbs	AD54-2460	92 lbs	WR54-2460-5	117 lbs	AD54-2460-5	115 lbs	Y Y Y Y Y
24" x 72"	WR54-2472	116 lbs	AD54-2472	112 lbs	WR54-2472-5	142 lbs	AD54-2472-5	142 lbs	Y Y Y Y Y
30" x 36"	WR54-3036	72 lbs	AD54-3036	68 lbs	WR54-3036-5	87 lbs	AD54-3036-5	85 lbs	Y Y Y Y Y
30" x 42"	WR54-3042	84 lbs	AD54-3042	80 lbs	WR54-3042-5	102 lbs	AD54-3042-5	100 lbs	Y Y Y Y Y
30" x 48"	WR54-3048	96 lbs	AD54-3048	92 lbs	WR54-3048-5	117 lbs	AD54-3048-5	115 lbs	Y Y Y Y Y
30" x 60"	WR54-3060	120 lbs	AD54-3060	116 lbs	WR54-3060-5	147 lbs	AD54-3060-5	145 lbs	Y Y Y Y Y
30" x 72"	WR54-3072	136 lbs	AD54-3072	132 lbs	WR54-3072-5	167 lbs	AD54-3072-5	165 lbs	Y Y Y Y Y
36" x 36"	WR54-3636	84 lbs	AD54-3636	80 lbs	WR54-3636-5	102 lbs	AD54-3636-5	100 lbs	Y Y Y Y Y
36" x 48"	WR54-3648	104 lbs	AD54-3648	100 lbs	WR54-3648-5	127 lbs	AD54-3648-5	125 lbs	Y Y Y Y Y
36" x 60"	WR54-3660	128 lbs	AD54-3660	124 lbs	WR54-3660-5	157 lbs	AD54-3660-5	155 lbs	Y Y Y Y Y
36" x 72"	WR54-3672	136 lbs	AD54-3672	132 lbs	WR54-3672-5	171 lbs	AD54-3672-5	169 lbs	Y Y Y Y Y

Shelving units include 4 posts and 4 or 5 shelves. Add-On units include 2 posts, 4 or 5 shelves and 8 or 10 S-Hooks. Y (Yes) N (No)



4 SHELF STARTER KIT
Stainless Steel Finish



5 SHELF STARTER KIT
Chrome Finish



Add-On Kits

Additional Add-On kits allow you to expand your Starter kit by sharing a middle set of posts. Configuration options include side to side, back to back and right angles (L-Shape). Add-On kits come complete with 2 posts, 4 or 5 shelves and 8 or 10 S-Hooks. Additional shelves and posts may be purchased separately. See chart on pg. 98. Units with Add-On kits cannot be made mobile. Finishes: Chrome, Stainless Steel, Proform Green, Gray and Black Epoxy

600-800 lb. LOAD CAPACITY PER SHELF

TO CHOOSE FINISH ADD FINISH SUFFIX TO MODEL NO.

Ex: Chrome WR63-1236C
Stainless WR63-1236S
Proform Green WR63-1236P
Gray WR63-1236GY
Black WR63-1236BK

Ex: Chrome WR63-1236C-5
Stainless WR63-1236S-5
Proform Green WR63-1236P-5
Gray WR63-1236GY-5
Black WR63-1236BK-5

Chrome
Stainless
Proform Green
GY Gray
BK Black

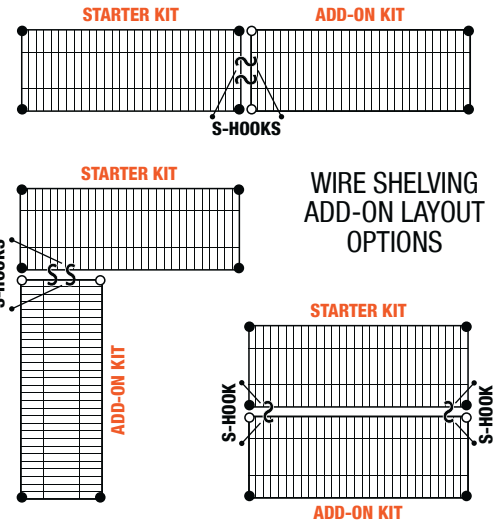

S-HOOKS
For continuous runs of shelving. Two hooks should be placed per shelf where two posts are not utilized.

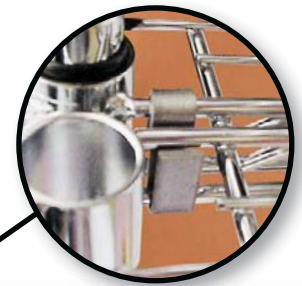

Table with columns: SHELF W" x L", MODEL NO., SHIP WGT, ADD-ON KIT MODEL NO., SHIP WGT, STARTER KIT MODEL NO., SHIP WGT, ADD-ON KIT MODEL NO., SHIP WGT, AVAILABLE FINISHES (C, S, P, GY, BK). Rows list various shelving unit configurations and their weights.

Shelving units include 4 posts and 4 or 5 shelves. Add-On units include 2 posts, 4 or 5 shelves and 8 or 10 S-Hooks. (Y (Yes) N (No))



4 SHELF ADD-ON KIT Chrome Finish

Starter Kits



Heavy-duty shelving units allow up to 800 lb. shelf capacity. Starter kits come complete with 4 posts and 4 or 5 shelves. Additional shelves may be purchased separately. See chart on **pg. 98**. Mobilize starter kit shelving unit using optional mobile kit, **WR-00H**, see **pg. 149**. **Finishes:** Chrome, Stainless Steel, Proform Green, Gray and Black Epoxy

600-800 lb. LOAD CAPACITY PER SHELF

TO CHOOSE FINISH ADD FINISH SUFFIX TO MODEL NO.

Ex: **Chrome** WR74-1236C
Stainless WR74-1236S
Proform Green WR74-1236P
Gray WR74-1236GY
Black WR74-1236BK

Ex: **Chrome** WR74-1236C-5
Stainless WR74-1236S-5
Proform Green WR74-1236P-5
Gray WR74-1236GY-5
Black WR74-1236BK-5

Chrome
Stainless
Proform Green
GY Gray
BK Black

SHELF W" x L"	74" H - WIRE SHELVING 4 SHELVES				74" H - WIRE SHELVING 5 SHELVES				AVAILABLE FINISHES					
	MODEL NO.	SHIP WGT	MODEL NO.	SHIP WGT	MODEL NO.	SHIP WGT	MODEL NO.	SHIP WGT	C	S	P	GY	BK	
12" x 36"	WR74-1236	44 lbs	AD74-1236	38 lbs	WR74-1236-5	51 lbs	AD74-1236-5	47 lbs	Y	Y	Y	Y	Y	
12" x 42"	WR74-1242	48 lbs	AD74-1242	42 lbs	WR74-1242-5	56 lbs	AD74-1242-5	52 lbs	Y	N	Y	Y	Y	
12" x 48"	WR74-1248	52 lbs	AD74-1248	46 lbs	WR74-1248-5	61 lbs	AD74-1248-5	57 lbs	Y	Y	Y	Y	Y	
12" x 60"	WR74-1260	60 lbs	AD74-1260	54 lbs	WR74-1260-5	74 lbs	AD74-1260-5	70 lbs	Y	Y	Y	Y	Y	
12" x 72"	WR74-1272	68 lbs	AD74-1272	62 lbs	WR74-1272-5	85 lbs	AD74-1272-5	81 lbs	Y	Y	Y	Y	Y	
14" x 24"	WR74-1424	40 lbs	AD74-1424	34 lbs	WR74-1424-5	46 lbs	AD74-1424-5	42 lbs	Y	N	Y	Y	Y	
14" x 30"	WR74-1430	44 lbs	AD74-1430	38 lbs	WR74-1430-5	51 lbs	AD74-1430-5	47 lbs	Y	Y	Y	Y	Y	
14" x 36"	WR74-1436	48 lbs	AD74-1436	42 lbs	WR74-1436-5	56 lbs	AD74-1436-5	52 lbs	Y	Y	Y	Y	Y	
14" x 42"	WR74-1442	56 lbs	AD74-1442	50 lbs	WR74-1442-5	66 lbs	AD74-1442-5	62 lbs	Y	Y	Y	Y	Y	
14" x 48"	WR74-1448	60 lbs	AD74-1448	54 lbs	WR74-1448-5	71 lbs	AD74-1448-5	67 lbs	Y	Y	Y	Y	Y	
14" x 54"	WR74-1454	64 lbs	AD74-1454	58 lbs	WR74-1454-5	76 lbs	AD74-1454-5	72 lbs	Y	Y	Y	Y	Y	
14" x 60"	WR74-1460	72 lbs	AD74-1460	66 lbs	WR74-1460-5	86 lbs	AD74-1460-5	82 lbs	Y	Y	Y	Y	Y	
14" x 72"	WR74-1472	84 lbs	AD74-1472	78 lbs	WR74-1472-5	101 lbs	AD74-1472-5	97 lbs	Y	Y	Y	Y	Y	
18" x 24"	WR74-1824	44 lbs	AD74-1824	38 lbs	WR74-1824-5	51 lbs	AD74-1824-5	47 lbs	Y	Y	Y	Y	Y	
18" x 30"	WR74-1830	48 lbs	AD74-1830	42 lbs	WR74-1830-5	56 lbs	AD74-1830-5	52 lbs	Y	Y	Y	Y	Y	
18" x 36"	WR74-1836	56 lbs	AD74-1836	50 lbs	WR74-1836-5	66 lbs	AD74-1836-5	62 lbs	Y	Y	Y	Y	Y	
18" x 42"	WR74-1842	60 lbs	AD74-1842	54 lbs	WR74-1842-5	71 lbs	AD74-1842-5	67 lbs	Y	Y	Y	Y	Y	
18" x 48"	WR74-1848	64 lbs	AD74-1848	58 lbs	WR74-1848-5	78 lbs	AD74-1848-5	74 lbs	Y	Y	Y	Y	Y	
18" x 54"	WR74-1854	76 lbs	AD74-1854	70 lbs	WR74-1854-5	91 lbs	AD74-1854-5	87 lbs	Y	Y	Y	Y	Y	
18" x 60"	WR74-1860	84 lbs	AD74-1860	78 lbs	WR74-1860-5	101 lbs	AD74-1860-5	97 lbs	Y	Y	Y	Y	Y	
18" x 72"	WR74-1872	96 lbs	AD74-1872	90 lbs	WR74-1872-5	116 lbs	AD74-1872-5	112 lbs	Y	Y	Y	Y	Y	
21" x 24"	WR74-2124	48 lbs	AD74-2124	42 lbs	WR74-2124-5	56 lbs	AD74-2124-5	52 lbs	Y	Y	Y	Y	Y	
21" x 30"	WR74-2130	52 lbs	AD74-2130	46 lbs	WR74-2130-5	61 lbs	AD74-2130-5	57 lbs	Y	Y	Y	Y	Y	
21" x 36"	WR74-2136	60 lbs	AD74-2136	54 lbs	WR74-2136-5	71 lbs	AD74-2136-5	67 lbs	Y	Y	Y	Y	Y	
21" x 42"	WR74-2142	64 lbs	AD74-2142	58 lbs	WR74-2142-5	76 lbs	AD74-2142-5	72 lbs	Y	Y	Y	Y	Y	
21" x 48"	WR74-2148	72 lbs	AD74-2148	66 lbs	WR74-2148-5	86 lbs	AD74-2148-5	82 lbs	Y	Y	Y	Y	Y	
21" x 54"	WR74-2154	80 lbs	AD74-2154	74 lbs	WR74-2154-5	96 lbs	AD74-2154-5	92 lbs	Y	Y	Y	Y	Y	
21" x 60"	WR74-2160	88 lbs	AD74-2160	82 lbs	WR74-2160-5	106 lbs	AD74-2160-5	102 lbs	Y	Y	Y	Y	Y	
21" x 72"	WR74-2172	112 lbs	AD74-2172	106 lbs	WR74-2172-5	136 lbs	AD74-2172-5	132 lbs	Y	Y	Y	Y	Y	
24" x 24"	WR74-2424	52 lbs	AD74-2424	46 lbs	WR74-2424-5	61 lbs	AD74-2424-5	57 lbs	Y	Y	Y	Y	Y	
24" x 30"	WR74-2430	60 lbs	AD74-2430	54 lbs	WR74-2430-5	71 lbs	AD74-2430-5	67 lbs	Y	Y	Y	Y	Y	
24" x 36"	WR74-2436	68 lbs	AD74-2436	62 lbs	WR74-2436-5	81 lbs	AD74-2436-5	77 lbs	Y	Y	Y	Y	Y	
24" x 42"	WR74-2442	76 lbs	AD74-2442	70 lbs	WR74-2442-5	91 lbs	AD74-2442-5	87 lbs	Y	Y	Y	Y	Y	
24" x 48"	WR74-2448	80 lbs	AD74-2448	74 lbs	WR74-2448-5	96 lbs	AD74-2448-5	92 lbs	Y	Y	Y	Y	Y	
24" x 54"	WR74-2454	88 lbs	AD74-2454	82 lbs	WR74-2454-5	106 lbs	AD74-2454-5	102 lbs	Y	Y	Y	Y	Y	
24" x 60"	WR74-2460	100 lbs	AD74-2460	94 lbs	WR74-2460-5	121 lbs	AD74-2460-5	117 lbs	Y	Y	Y	Y	Y	
24" x 72"	WR74-2472	120 lbs	AD74-2472	114 lbs	WR74-2472-5	146 lbs	AD74-2472-5	142 lbs	Y	Y	Y	Y	Y	
30" x 36"	WR74-3036	76 lbs	AD74-3036	70 lbs	WR74-3036-5	91 lbs	AD74-3036-5	87 lbs	Y	Y	Y	Y	Y	
30" x 42"	WR74-3042	88 lbs	AD74-3042	82 lbs	WR74-3042-5	106 lbs	AD74-3042-5	102 lbs	Y	Y	Y	Y	Y	
30" x 48"	WR74-3048	100 lbs	AD74-3048	94 lbs	WR74-3048-5	121 lbs	AD74-3048-5	117 lbs	Y	Y	Y	Y	Y	
30" x 60"	WR74-3060	124 lbs	AD74-3060	118 lbs	WR74-3060-5	151 lbs	AD74-3060-5	147 lbs	Y	Y	Y	Y	Y	
30" x 72"	WR74-3072	140 lbs	AD74-3072	134 lbs	WR74-3072-5	171 lbs	AD74-3072-5	167 lbs	Y	Y	Y	Y	Y	
36" x 36"	WR74-3636	88 lbs	AD74-3636	82 lbs	WR74-3636-5	106 lbs	AD74-3636-5	102 lbs	Y	Y	Y	Y	Y	
36" x 48"	WR74-3648	108 lbs	AD74-3648	102 lbs	WR74-3648-5	131 lbs	AD74-3648-5	127 lbs	Y	Y	Y	Y	Y	
36" x 60"	WR74-3660	132 lbs	AD74-3660	126 lbs	WR74-3660-5	161 lbs	AD74-3660-5	157 lbs	Y	Y	Y	Y	Y	
36" x 72"	WR74-3672	140 lbs	AD74-3672	134 lbs	WR74-3672-5	175 lbs	AD74-3672-5	171 lbs	Y	Y	Y	Y	Y	

Shelving units include 4 posts and 4 or 5 shelves. Add-On units include 2 posts, 4 or 5 shelves and 8 or 10 S-Hooks.

Y (Yes) N (No)



4 SHELF STARTER KIT
Proform Green Epoxy Finish



5 SHELF STARTER KIT
Black Epoxy Finish



Add-On Kits

Additional Add-On kits allow you to expand your Starter kit by sharing a set of posts. Configuration options include side to side, back to back and right angles (L-Shape). Add-On kits come complete with 2 posts, 4 or 5 shelves and 8 or 10 S-Hooks. Additional shelves and posts may be purchased separately. See chart on pg. 98. Units with Add-On kit cannot be made mobile. Finishes: Chrome, Stainless Steel, Proform Green, Gray and Black Epoxy

600-800 lb. LOAD CAPACITY PER SHELF

TO CHOOSE FINISH ADD FINISH SUFFIX TO MODEL NO.

Ex: Chrome WR86-1236C
Stainless WR86-1236S
Proform Green WR86-1236P
Gray WR86-1236GY
Black WR86-1236BK

Ex: Chrome WR86-1236C-5
Stainless WR86-1236S-5
Proform Green WR86-1236P-5
Gray WR86-1236GY-5
Black WR86-1236BK-5

Chrome
Stainless
Proform Green
GY Gray
BK Black

Table with columns: SHELF W" x L", MODEL NO., SHIP WGT, ADD-ON KIT, STARTER KIT, MODEL NO., SHIP WGT, ADD-ON KIT, AVAILABLE FINISHES (C, S, P, GY, BK). Rows list various shelving unit models and their specifications.

Shelving units include 4 posts and 4 or 5 shelves. Add-On units include 2 posts, 4 or 5 shelves and 8 or 10 S-Hooks. (Y (Yes) N (No))

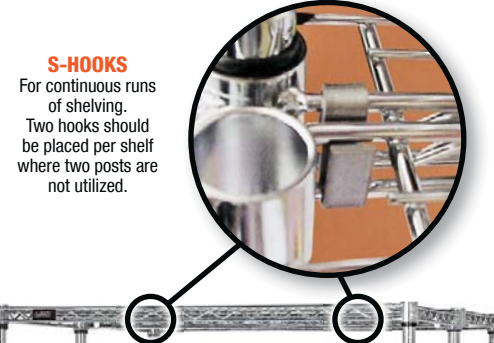
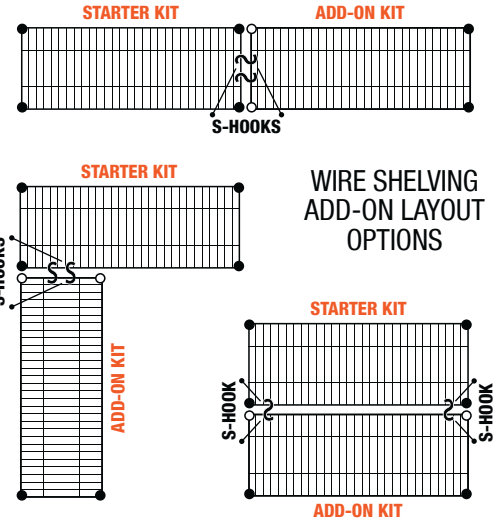

S-HOOKS For continuous runs of shelving. Two hooks should be placed per shelf where two posts are not utilized.



4 SHELF BACK TO BACK SYSTEM Chrome Finish



4 Shelf Starter Kits

Solid flat shelves allows for storage from small to large items, and the marine edge perimeter prevents spillage. The double hemmed 18 gauge galvanized steel provides the solid shelf excellent strength characteristics.



MOBILIZE YOUR SHELVING
DB - Donut Bumper
Non-marking donut bumper used to protect walls and help cushion impact.

WR-00H (Mobile Kit)*
Set of four swivel thermoplastic resin 5" x 1-1/4" casters, two with brakes. Can be used with all units shown. 1,200 lb. load capacity. *Mobile kits recommended only for shelves 18" and deeper.



4 SHELF STARTER KIT



QSMC Shelf Clamp
Shelf Clamp eliminates 2 posts per shelving section. Two QSMC clamps are required per shelf. Finish: Aluminum (Sold individually)

4 Shelf Add-On Kits

Additional Add-On kits allow you to expand your Starter kit by sharing a set of posts. Configuration options include side to side, back to back and right angles (L-Shape). Add-on units consist of 4 shelves, 2 posts and 8 shelf clamps.

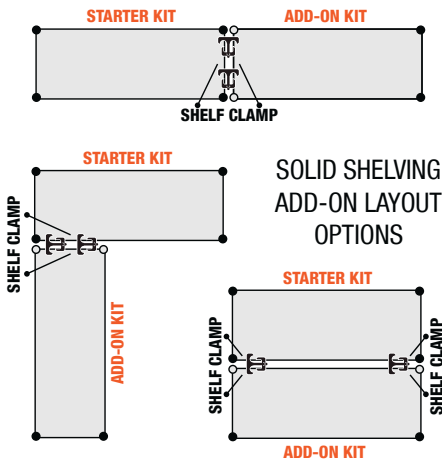

Table with 4 columns: STARTER KIT and ADD-ON KIT for 54" and 63" units. Columns include SHELF W" x L", MODEL NO., and SHIP WGT. Rows list various model numbers and their weights.

Shelving units include 4 posts and 4 shelves. Add-On units include 2 posts, 4 shelves and 8 shelf clamps.

18 GAUGE GALVANIZED STEEL

400-600 lb. LOAD CAPACITY PER SHELF

Table with 4 columns: STARTER KIT and ADD-ON KIT for 74" and 86" units. Columns include SHELF W" x L", MODEL NO., and SHIP WGT. Rows list various model numbers and their weights.

Shelving units include 4 posts and 4 shelves. Add-On units include 2 posts, 4 shelves and 8 shelf clamps.



54" H - GALVANIZED SOLID SHELVING 5 SHELVES

Table with 8 columns: SHELF W" x L", MODEL NO., SHIP WGT, ADD-ON KIT MODEL NO., SHIP WGT, STARTER KIT MODEL NO., SHIP WGT, ADD-ON KIT MODEL NO., SHIP WGT. Rows list various shelving unit models and their weights.

Shelving units include 4 posts and 5 shelves. Add-On units include 2 posts, 5 shelves and 10 shelf clamps.

18 GAUGE GALVANIZED STEEL

400-600 lb. LOAD CAPACITY PER SHELF

74" H - GALVANIZED SOLID SHELVING 5 SHELVES

Table with 8 columns: SHELF W" x L", MODEL NO., SHIP WGT, ADD-ON KIT MODEL NO., SHIP WGT, STARTER KIT MODEL NO., SHIP WGT, ADD-ON KIT MODEL NO., SHIP WGT. Rows list various shelving unit models and their weights.

Shelving units include 4 posts and 5 shelves. Add-On units include 2 posts, 5 shelves and 10 shelf clamps.

5 Shelf Starter Kits

Solid flat shelves allows for storage from small to large items, and the marine edge perimeter prevents spillage. The double hemmed 18 gauge galvanized steel gives the solid shelf excellent strength characteristics.



MOBILIZE YOUR SHELVING

DB - Donut Bumper Non-marking donut bumper used to protect walls and help cushion impact.

WR-00H (Mobile Kit)*

Set of four swivel thermoplastic resin 5" x 1-1/4" casters, two with brakes. Can be used with all units shown. 1,200 lb. load capacity. *Mobile kits recommended only for shelves 18" and deeper.



QSMC Shelf Clamp Shelf Clamp eliminates 2 posts per shelving section. Two QSMC clamps are required per shelf. Finish: Aluminum (Sold individually)



5 SHELF ADD-ON KIT

5 Shelf Add-On Kits

Additional Add-On kit allows you to expand your Starter kit by sharing a set of posts. Configuration options include side to side, back to back and right angles (L-Shape). Add-on units consist of 5 shelves, 2 posts and 10 shelf clamps.

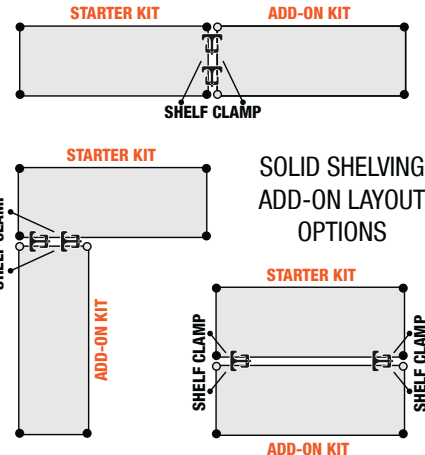



4 Shelf Starter Kits

Solid flat shelves allows for storage from small to large items, and the marine edge perimeter prevents spillage. The double hemmed 18 gauge 304 stainless steel gives the solid shelf excellent strength characteristics. All solid shelf units consist of 4 shelves and 4 posts. Mobilize starter kit shelving unit using optional mobile kit WR-00HS, see pg. 149. *Finish:* Stainless Steel



MOBILIZE YOUR SHELVING

DB - Donut Bumper

Non-marking donut bumper used to protect walls and help cushion impact.

WR-00HS (Mobile Kit)*

Set of four swivel 5" x 1-1/4" thermo-plastic resin stainless steel casters with zerk grease fittings, 2 with brake. Can be used with all units shown. 1,200 lb. load capacity. *Mobile kits recommended only for shelves 18" and deeper.



4 SHELF STARTER KIT



QSMC Shelf Clamp
Shelf Clamp eliminates 2 post per shelving section. Two QSMC clamps are required per shelf. *Finish:* Aluminum (Sold individually)

4 Shelf Add-On Kits

Additional Add-On kits allow you to expand your Starter kit by sharing a set of posts. Configuration options include side to side, back to back and right angles (L-Shape). Add-on units consist of 4 shelves, 2 posts and 8 shelf clamps. Additional shelves and posts may be purchased separately, see chart on pg. 99. Units with Add-On kit cannot be made mobile. *Finish:* Stainless Steel

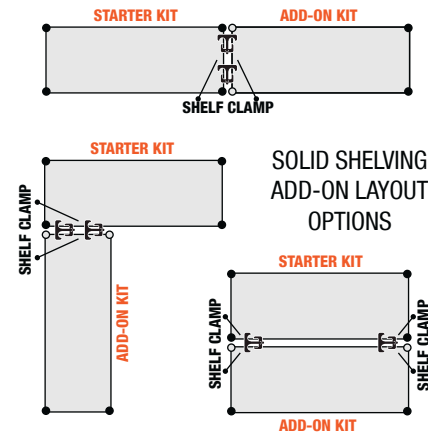

54"H - STAINLESS SOLID SHELVING 4 SHELVES				63"H - STAINLESS SOLID SHELVING 4 SHELVES				
STARTER KIT			ADD-ON KIT		STARTER KIT		ADD-ON KIT	
SHELF W" x L"	MODEL NO.	SHIP WGT	MODEL NO.	SHIP WGT	MODEL NO.	SHIP WGT	MODEL NO.	SHIP WGT
14" x 36"	WRS4-54-1436SS	68 lbs	WRSAD4-54-1436SS	65 lbs	WRS4-63-1436SS	72 lbs	WRSAD4-63-1436SS	67 lbs
14" x 42"	WRS4-54-1442SS	72 lbs	WRSAD4-54-1442SS	69 lbs	WRS4-63-1442SS	76 lbs	WRSAD4-63-1442SS	71 lbs
14" x 48"	WRS4-54-1448SS	80 lbs	WRSAD4-54-1448SS	77 lbs	WRS4-63-1448SS	84 lbs	WRSAD4-63-1448SS	79 lbs
14" x 54"	WRS4-54-1454SS	92 lbs	WRSAD4-54-1454SS	89 lbs	WRS4-63-1454SS	96 lbs	WRSAD4-63-1454SS	91 lbs
14" x 60"	WRS4-54-1460SS	100 lbs	WRSAD4-54-1460SS	97 lbs	WRS4-63-1460SS	104 lbs	WRSAD4-63-1460SS	99 lbs
14" x 72"	WRS4-54-1472SS	116 lbs	WRSAD4-54-1472SS	113 lbs	WRS4-63-1472SS	120 lbs	WRSAD4-63-1472SS	115 lbs
18" x 24"	WRS4-54-1824SS	56 lbs	WRSAD4-54-1824SS	53 lbs	WRS4-63-1824SS	60 lbs	WRSAD4-63-1824SS	55 lbs
18" x 30"	WRS4-54-1830SS	68 lbs	WRSAD4-54-1830SS	65 lbs	WRS4-63-1830SS	72 lbs	WRSAD4-63-1830SS	67 lbs
18" x 36"	WRS4-54-1836SS	76 lbs	WRSAD4-54-1836SS	73 lbs	WRS4-63-1836SS	80 lbs	WRSAD4-63-1836SS	75 lbs
18" x 42"	WRS4-54-1842SS	84 lbs	WRSAD4-54-1842SS	81 lbs	WRS4-63-1842SS	88 lbs	WRSAD4-63-1842SS	83 lbs
18" x 48"	WRS4-54-1848SS	92 lbs	WRSAD4-54-1848SS	89 lbs	WRS4-63-1848SS	96 lbs	WRSAD4-63-1848SS	91 lbs
18" x 54"	WRS4-54-1854SS	100 lbs	WRSAD4-54-1854SS	97 lbs	WRS4-63-1854SS	104 lbs	WRSAD4-63-1854SS	99 lbs
18" x 60"	WRS4-54-1860SS	108 lbs	WRSAD4-54-1860SS	105 lbs	WRS4-63-1860SS	112 lbs	WRSAD4-63-1860SS	107 lbs
18" x 72"	WRS4-54-1872SS	120 lbs	WRSAD4-54-1872SS	117 lbs	WRS4-63-1872SS	124 lbs	WRSAD4-63-1872SS	119 lbs
21" x 24"	WRS4-54-2124SS	64 lbs	WRSAD4-54-2124SS	61 lbs	WRS4-63-2124SS	68 lbs	WRSAD4-63-2124SS	63 lbs
21" x 30"	WRS4-54-2130SS	72 lbs	WRSAD4-54-2130SS	69 lbs	WRS4-63-2130SS	76 lbs	WRSAD4-63-2130SS	71 lbs
21" x 36"	WRS4-54-2136SS	84 lbs	WRSAD4-54-2136SS	81 lbs	WRS4-63-2136SS	88 lbs	WRSAD4-63-2136SS	83 lbs
21" x 42"	WRS4-54-2142SS	96 lbs	WRSAD4-54-2142SS	93 lbs	WRS4-63-2142SS	100 lbs	WRSAD4-63-2142SS	95 lbs
21" x 48"	WRS4-54-2148SS	104 lbs	WRSAD4-54-2148SS	101 lbs	WRS4-63-2148SS	108 lbs	WRSAD4-63-2148SS	103 lbs
21" x 54"	WRS4-54-2154SS	112 lbs	WRSAD4-54-2154SS	109 lbs	WRS4-63-2154SS	116 lbs	WRSAD4-63-2154SS	111 lbs
21" x 60"	WRS4-54-2160SS	124 lbs	WRSAD4-54-2160SS	121 lbs	WRS4-63-2160SS	128 lbs	WRSAD4-63-2160SS	123 lbs
21" x 72"	WRS4-54-2172SS	132 lbs	WRSAD4-54-2172SS	129 lbs	WRS4-63-2172SS	136 lbs	WRSAD4-63-2172SS	131 lbs
24" x 24"	WRS4-54-2424SS	72 lbs	WRSAD4-54-2424SS	69 lbs	WRS4-63-2424SS	76 lbs	WRSAD4-63-2424SS	71 lbs
24" x 30"	WRS4-54-2430SS	80 lbs	WRSAD4-54-2430SS	77 lbs	WRS4-63-2430SS	84 lbs	WRSAD4-63-2430SS	79 lbs
24" x 36"	WRS4-54-2436SS	88 lbs	WRSAD4-54-2436SS	85 lbs	WRS4-63-2436SS	92 lbs	WRSAD4-63-2436SS	87 lbs
24" x 42"	WRS4-54-2442SS	100 lbs	WRSAD4-54-2442SS	97 lbs	WRS4-63-2442SS	104 lbs	WRSAD4-63-2442SS	99 lbs
24" x 48"	WRS4-54-2448SS	108 lbs	WRSAD4-54-2448SS	105 lbs	WRS4-63-2448SS	112 lbs	WRSAD4-63-2448SS	107 lbs
24" x 54"	WRS4-54-2454SS	124 lbs	WRSAD4-54-2454SS	121 lbs	WRS4-63-2454SS	128 lbs	WRSAD4-63-2454SS	123 lbs
24" x 60"	WRS4-54-2460SS	136 lbs	WRSAD4-54-2460SS	133 lbs	WRS4-63-2460SS	140 lbs	WRSAD4-63-2460SS	135 lbs
24" x 72"	WRS4-54-2472SS	148 lbs	WRSAD4-54-2472SS	145 lbs	WRS4-63-2472SS	152 lbs	WRSAD4-63-2472SS	147 lbs

Shelving units include 4 posts and 4 shelves. Add-On units include 2 posts, 4 shelves and 8 shelf clamps.

304 STAINLESS STEEL

400-600 lb. LOAD CAPACITY PER SHELF

74"H - STAINLESS SOLID SHELVING 4 SHELVES				86"H - STAINLESS SOLID SHELVING 4 SHELVES				
STARTER KIT			ADD-ON KIT		STARTER KIT		ADD-ON KIT	
SHELF W" x L"	MODEL NO.	SHIP WGT	MODEL NO.	SHIP WGT	MODEL NO.	SHIP WGT	MODEL NO.	SHIP WGT
14" x 36"	WRS4-74-1436SS	72 lbs	WRSAD4-74-1436SS	67 lbs	WRS4-86-1436SS	76 lbs	WRSAD4-86-1436SS	69 lbs
14" x 42"	WRS4-74-1442SS	76 lbs	WRSAD4-74-1442SS	71 lbs	WRS4-86-1442SS	80 lbs	WRSAD4-86-1442SS	73 lbs
14" x 48"	WRS4-74-1448SS	84 lbs	WRSAD4-74-1448SS	79 lbs	WRS4-86-1448SS	88 lbs	WRSAD4-86-1448SS	81 lbs
14" x 54"	WRS4-74-1454SS	96 lbs	WRSAD4-74-1454SS	91 lbs	WRS4-86-1454SS	100 lbs	WRSAD4-86-1454SS	93 lbs
14" x 60"	WRS4-74-1460SS	104 lbs	WRSAD4-74-1460SS	99 lbs	WRS4-86-1460SS	108 lbs	WRSAD4-86-1460SS	101 lbs
14" x 72"	WRS4-74-1472SS	120 lbs	WRSAD4-74-1472SS	115 lbs	WRS4-86-1472SS	124 lbs	WRSAD4-86-1472SS	117 lbs
18" x 24"	WRS4-74-1824SS	60 lbs	WRSAD4-74-1824SS	55 lbs	WRS4-86-1824SS	64 lbs	WRSAD4-86-1824SS	57 lbs
18" x 30"	WRS4-74-1830SS	72 lbs	WRSAD4-74-1830SS	67 lbs	WRS4-86-1830SS	76 lbs	WRSAD4-86-1830SS	69 lbs
18" x 36"	WRS4-74-1836SS	80 lbs	WRSAD4-74-1836SS	75 lbs	WRS4-86-1836SS	84 lbs	WRSAD4-86-1836SS	77 lbs
18" x 42"	WRS4-74-1842SS	88 lbs	WRSAD4-74-1842SS	83 lbs	WRS4-86-1842SS	92 lbs	WRSAD4-86-1842SS	85 lbs
18" x 48"	WRS4-74-1848SS	96 lbs	WRSAD4-74-1848SS	91 lbs	WRS4-86-1848SS	100 lbs	WRSAD4-86-1848SS	93 lbs
18" x 54"	WRS4-74-1854SS	104 lbs	WRSAD4-74-1854SS	99 lbs	WRS4-86-1854SS	108 lbs	WRSAD4-86-1854SS	101 lbs
18" x 60"	WRS4-74-1860SS	112 lbs	WRSAD4-74-1860SS	107 lbs	WRS4-86-1860SS	116 lbs	WRSAD4-86-1860SS	109 lbs
18" x 72"	WRS4-74-1872SS	124 lbs	WRSAD4-74-1872SS	119 lbs	WRS4-86-1872SS	128 lbs	WRSAD4-86-1872SS	121 lbs
21" x 24"	WRS4-74-2124SS	68 lbs	WRSAD4-74-2124SS	63 lbs	WRS4-86-2124SS	72 lbs	WRSAD4-86-2124SS	65 lbs
21" x 30"	WRS4-74-2130SS	76 lbs	WRSAD4-74-2130SS	71 lbs	WRS4-86-2130SS	80 lbs	WRSAD4-86-2130SS	73 lbs
21" x 36"	WRS4-74-2136SS	88 lbs	WRSAD4-74-2136SS	83 lbs	WRS4-86-2136SS	92 lbs	WRSAD4-86-2136SS	85 lbs
21" x 42"	WRS4-74-2142SS	100 lbs	WRSAD4-74-2142SS	95 lbs	WRS4-86-2142SS	104 lbs	WRSAD4-86-2142SS	97 lbs
21" x 48"	WRS4-74-2148SS	108 lbs	WRSAD4-74-2148SS	103 lbs	WRS4-86-2148SS	112 lbs	WRSAD4-86-2148SS	105 lbs
21" x 54"	WRS4-74-2154SS	116 lbs	WRSAD4-74-2154SS	111 lbs	WRS4-86-2154SS	120 lbs	WRSAD4-86-2154SS	113 lbs
21" x 60"	WRS4-74-2160SS	128 lbs	WRSAD4-74-2160SS	123 lbs	WRS4-86-2160SS	132 lbs	WRSAD4-86-2160SS	125 lbs
21" x 72"	WRS4-74-2172SS	136 lbs	WRSAD4-74-2172SS	131 lbs	WRS4-86-2172SS	140 lbs	WRSAD4-86-2172SS	133 lbs
24" x 24"	WRS4-74-2424SS	76 lbs	WRSAD4-74-2424SS	71 lbs	WRS4-86-2424SS	80 lbs	WRSAD4-86-2424SS	73 lbs
24" x 30"	WRS4-74-2430SS	84 lbs	WRSAD4-74-2430SS	79 lbs	WRS4-86-2430SS	88 lbs	WRSAD4-86-2430SS	81 lbs
24" x 36"	WRS4-74-2436SS	92 lbs	WRSAD4-74-2436SS	87 lbs	WRS4-86-2436SS	96 lbs	WRSAD4-86-2436SS	89 lbs
24" x 42"	WRS4-74-2442SS	104 lbs	WRSAD4-74-2442SS	99 lbs	WRS4-86-2442SS	108 lbs	WRSAD4-86-2442SS	101 lbs
24" x 48"	WRS4-74-2448SS	112 lbs	WRSAD4-74-2448SS	107 lbs	WRS4-86-2448SS	116 lbs	WRSAD4-86-2448SS	109 lbs
24" x 54"	WRS4-74-2454SS	128 lbs	WRSAD4-74-2454SS	123 lbs	WRS4-86-2454SS	132 lbs	WRSAD4-86-2454SS	125 lbs
24" x 60"	WRS4-74-2460SS	140 lbs	WRSAD4-74-2460SS	135 lbs	WRS4-86-2460SS	144 lbs	WRSAD4-86-2460SS	137 lbs
24" x 72"	WRS4-74-2472SS	152 lbs	WRSAD4-74-2472SS	147 lbs	WRS4-86-2472SS	156 lbs	WRSAD4-86-2472SS	149 lbs

Shelving units include 4 posts and 4 shelves. Add-On units include 2 posts, 4 shelves and 8 shelf clamps.



Table with 4 main columns: 54"H - STAINLESS SOLID SHELVING 5 SHELVES (STARTER KIT, ADD-ON KIT), 63"H - STAINLESS SOLID SHELVING 5 SHELVES (STARTER KIT, ADD-ON KIT). Each sub-column has Model No., Shelf W" x L", and Ship Wgt.

Shelving units include 4 posts and 5 shelves. Add-On units include 2 posts, 5 shelves and 10 shelf clamps.

304 STAINLESS STEEL

400-600 lb. LOAD CAPACITY PER SHELF

Table with 4 main columns: 74"H - STAINLESS SOLID SHELVING 5 SHELVES (STARTER KIT, ADD-ON KIT), 86"H - STAINLESS SOLID SHELVING 5 SHELVES (STARTER KIT, ADD-ON KIT). Each sub-column has Model No., Shelf W" x L", and Ship Wgt.

Shelving units include 4 posts and 5 shelves. Add-On units include 2 posts, 5 shelves and 10 shelf clamps.

5 Shelf Starter Kits

Solid flat shelves allows for storage from small to large items, and the marine edge perimeter prevents spillage. The double hemmed 18 gauge 304 stainless steel gives the solid shelf excellent strength characteristics.



MOBILIZE YOUR SHELVING

DB - Donut Bumper Non-marking donut bumper used to protect walls and help cushion impact.

WR-00HS (Mobile Kit)* Set of four swivel 5" x 1-1/4" thermo-plastic resin stainless steel casters with zerk grease fittings, 2 with brake. Can be used with all units shown. 1,200 lb. load capacity. *Mobile kits recommended only for shelves 18" and deeper.



QSMC Shelf Clamp Shelf Clamp eliminates 2 posts per shelving section. Two QSMC clamps are required per shelf. Finish: Aluminum (Sold individually)



5 SHELF ADD-ON KIT

5 Shelf Add-On Kits

Additional Add-On kits allow you to expand your Starter kit by sharing a set of posts. Configuration options include side to side, back to back and right angles (L-Shape). Add-on units consist of 5 shelves, 2 posts and 10 shelf clamps.

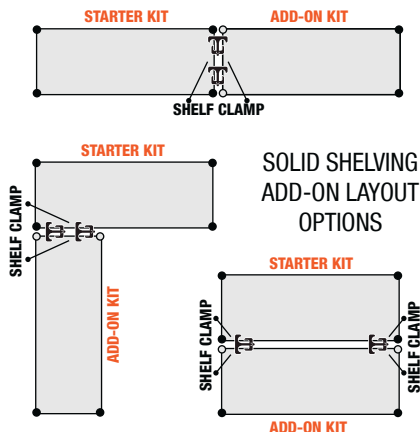

Convenient 1 Box Wire Shelving Units



4 shelf configuration, consumer grade wire shelving unit. Super competitive cost. All packed in 1 box for super easy inventory control, shipping, and receiving.



Finishes available in: Chrome

MODEL NO.	DIMENSIONS W" x L" x H"	SHIP WGT
RWR72-1830LD	18" x 30" x 72"	35 lbs
RWR72-1836LD	18" x 36" x 72"	38 lbs
RWR72-1842LD	18" x 42" x 72"	42 lbs
RWR72-1848LD	18" x 48" x 72"	46 lbs
RWR72-2430LD	24" x 30" x 72"	40 lbs
RWR72-2436LD	24" x 36" x 72"	46 lbs
RWR72-2442LD	24" x 42" x 72"	51 lbs
RWR72-2448LD	24" x 48" x 72"	56 lbs

MOBILIZE YOUR SHELVING

W-PLI - Post Insert

Each unit will require one 4-pack.

WR-3 (Mobile Kit)

Set of four 3" polyurethane casters, all with brakes. Can be used with all units shown. 800 lb. load capacity.



4 SHELF UNIT
Chrome Finish

PERFORMANCE FEATURES:

- 300 lb. load capacity per shelf
- Assembles in minutes
- Wire design allows for air circulation and minimal dust buildup
- Shelves easily adjust on 1" centers to your exact needs
- Ideal storage solution for any commercial, office, warehouse or home application
- Bright chrome finish
- Includes posts, shelves, and all needed hardware - all in one box
- No tools required



SUPER LOW PRICE

SUPER LOW TRANSIT COST

SINGLE BOX SHIPMENT

300 lb. LOAD CAPACITY PER SHELF

Inside the Single Box Unit

- 4 posts
- 4 wire shelves
- 4 packs of split sleeves

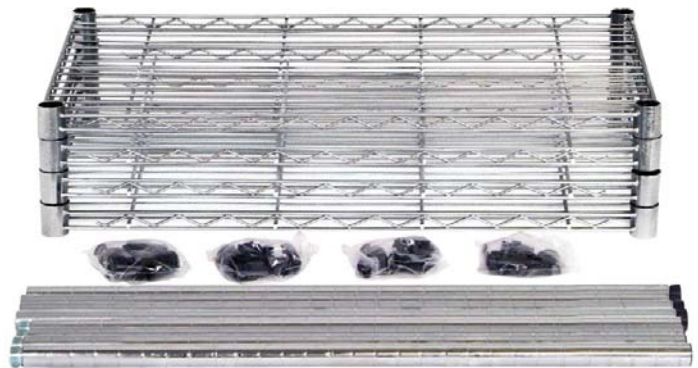



Smooth, vented, open grid surface allows for air circulation and minimal dust buildup



NEW
PLASTIC MAT SHELVING UNITS

6 SIZES AVAILABLE AS SINGLE BOX SHIPMENT

4 SHELF UNIT
Blue Finish



PERFORMANCE FEATURES:

- 600 lb. load capacity per shelf
- Assembles in minutes
- Smooth, vented, open grid surface allows for air circulation and minimal dust buildup
- Plastic mats can be easily removed for cleaning and are dish washer safe
- Plastic material will never dent, chip, rust or corrode
- Shelves easily adjust to your exact height needs
- Ideal storage solution for any commercial or home application
- Posts and frames are steel with epoxy, antimicrobial blue finish

SUPER LOW PRICE

SUPER LOW TRANSIT COST

Wire Plastic Mat Shelving Units

4 shelf configuration, consumer grade wire/plastic mat hybrid shelving unit. Super competitive cost. Six size options ship in 1 box for super easy inventory control, shipping, and receiving.

Metal finish: ● Antimicrobial Blue

MODEL NO.	DIMENSIONS W" x L" x H"	SHIP WGT
18" Deep Units		
RPWR72-1830E*	18" x 30" x 72"	44 lbs
RPWR72-1836E*	18" x 36" x 72"	52 lbs
RPWR72-1842E	18" x 42" x 72"	56 lbs
RPWR72-1848E*	18" x 48" x 72"	60 lbs
RPWR72-1860E	18" x 60" x 72"	68 lbs
RPWR72-1872E	18" x 72" x 72"	80 lbs
24" Deep Units		
RPWR72-2430E*	24" x 30" x 72"	60 lbs
RPWR72-2436E*	24" x 36" x 72"	68 lbs
RPWR72-2442E	24" x 42" x 72"	72 lbs
RPWR72-2448E*	24" x 48" x 72"	76 lbs
RPWR72-2460E	24" x 60" x 72"	92 lbs
RPWR72-2472E	24" x 72" x 72"	108 lbs

***PACKAGED AS SINGLE BOX SHELVING UNITS**

600 lb. LOAD CAPACITY PER SHELF

Additional Wire Plastic Mat Shelves

Metal finish: ● Antimicrobial Blue

MODEL NO.	SHELF W" x L"	SHIP WGT
18" Deep - Shelves		
RP1830E	18" x 30"	7 lbs
RP1836E	18" x 36"	9 lbs
RP1842E	18" x 42"	10 lbs
RP1848E	18" x 48"	11 lbs
RP1860E	18" x 60"	13 lbs
RP1872E	18" x 72"	16 lbs
24" Deep - Shelves		
RP2430E	24" x 30"	11 lbs
RP2436E	24" x 36"	13 lbs
RP2442E	24" x 42"	14 lbs
RP2448E	24" x 48"	15 lbs
RP2460E	24" x 60"	19 lbs
RP2472E	24" x 72"	23 lbs

Additional Wire Plastic Mat Posts

- One piece post

Metal finish: ● Antimicrobial Blue

MODEL NO.	DESCRIPTION	SHIP WGT
RP63E	63"H Post	3 lb
RP72E	72"H Post	4 lb

Corner Wire Shelving



When in need of more storage space, Quantum Corner Wire Shelving is the answer. It's great for any corner area. It is versatile and durable, it is easy to assemble. Each shelf holds up to 700 lbs., evenly distributed. This versatile storage option will help your rooms stay neat, organized and maximized.

Finishes available in: Chrome

MODEL NO.	SHELF DIMENSIONS A" x B" x C" x D" x E"	SHIP WGT
Corner Wire Shelves		
1836CRNC	37-7/8" x 50-1/4" x 36" x 18" x 27"	16 lbs
2442CRNC	46" x 58-1/2" x 41-3/4" x 24" x 26-1/2"	21 lbs
74"H - Corner Wire Shelving 4 Shelf System		
WR74-1836CRNC	37-7/8" x 50-1/4" x 36" x 18" x 27"	80 lbs
WR74-2442CRNC	46" x 58-1/2" x 41-3/4" x 24" x 26-1/2"	100 lbs
74"H - Corner Wire Shelving 5 Shelf System		
WR74-1836CRNC-5	37-7/8" x 50-1/4" x 36" x 18" x 27"	96 lbs
WR74-2442CRNC-5	46" x 58-1/2" x 41-3/4" x 24" x 26-1/2"	121 lbs

MOBILIZE YOUR SHELVING

DB - Donut Bumper
Non-marking donut bumper used to protect walls and help cushion impact.



WR-00H-5 (Mobile Kit)

Set of five swivel thermoplastic resin 5" x 1-1/4" casters, two with brakes. Can be used with all units shown. 1,500 lb. load capacity.



4 SHELF UNIT
Chrome Finish

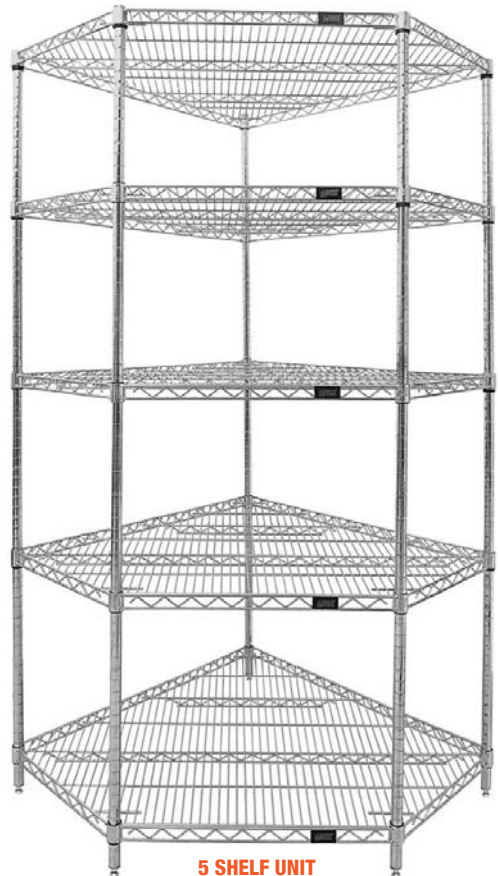

5 SHELF UNIT
Chrome Finish



1836CRNC
Corner Wire Shelf
(Use with 18" deep wire shelving)

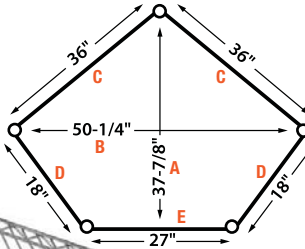

700 lb.
LOAD CAPACITY
PER SHELF



2442CRNC
Corner Wire Shelf
(Use with 24" deep wire shelving)

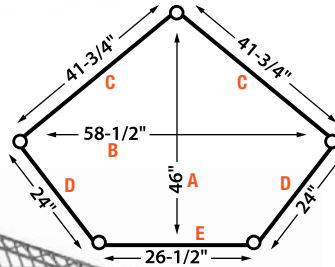

PERFORMANCE FEATURES:

- 700 lb. load capacity per shelf
- Easy assembly with no tools needed
- Compatible with 18" and 24" deep Wire Shelving Add-On Units
- Shelves easily adjust on 1" centers to your exact needs
- Ideal storage solution for any commercial, office, warehouse or home application
- Bright chrome finish

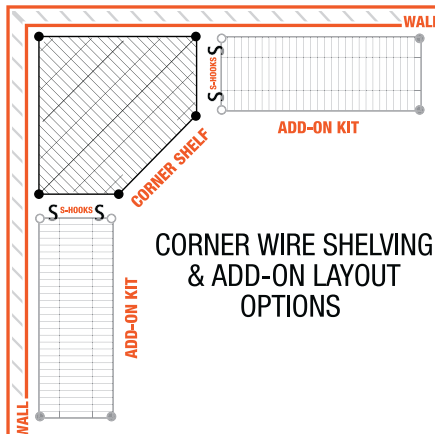

CORNER WIRE SHELVING
& ADD-ON LAYOUT
OPTIONS



Reel Shelving Units



Quantum Reel Shelving offers a safe and efficient method of transporting and storing standard size component reels. New reel shelves are chrome plated and can be used in conjunction with same size standard flat wire shelves. Units are available with conductive accessories providing a static safe storage system to address reel handling and providing stationary or mobile complete storage systems for PCB manufacturers. **Finish:** Chrome

MODEL NO.	DIMENSIONS W" x L"	HANDLES REEL SIZE	REEL CAPACITY	SHIP WGT
1836R16C	18" x 36"	13"-15"	15	10 lbs
1836R40C	18" x 36"	7"	78	12 lbs

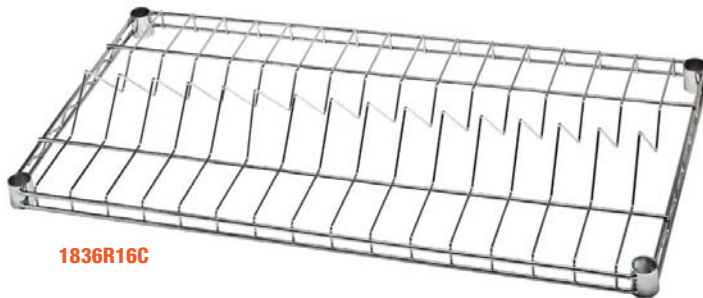

1836R16C

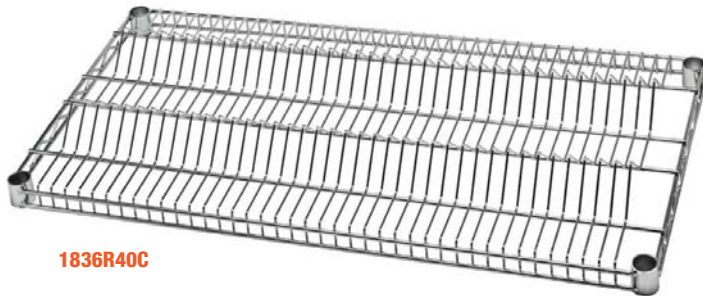

1836R40C

400 lb.
LOAD CAPACITY PER SHELF



WRC-R264C
Chrome Finish



MODEL NO.	DIMENSIONS W" x L" x H"	NO. OF SHELVES	SHIP WGT
WRC-R60C	18" x 36" x 69"	(4) 15-Reel Wire Shelves	75 lbs
WRC-R264C	18" x 36" x 69"	(2) 15-Reel Wire Shelves - (3) 78-Reel Wire Shelves	81 lbs
WRC-R468C	18" x 36" x 69"	(6) 78-Reel Wire Shelves	87 lbs

CARTS ARE CONDUCTIVE/ESD SAFE AND INCLUDES CONDUCTIVE CASTERS, CONDUCTIVE PLASTIC SPLIT SLEEVES, AND DRAG CHAIN

Conductive Accessories

WR-00CO
Conductive Casters

- 4 swivel
- 2 brakes
- 2 non-brakes



WR-SSCO
Conductive Plastic Split Sleeves



ESD-DC
Drag Chain





PARTITION Wall Systems

1017HBC
Basket
11-7/8"W x 18"L x 7-1/2"H

HBL165C
16-1/2" Clear Label Holder
also available in 3" and 34-1/2"

Stackable Shelf Bins
available on *pg. 32*

QLP-3661HC
Louvered Panel
36"L x 61"H
used with mounting frame

WS-PM36HC

1035HBC
Basket
11-7/8"W x 36"L x 7-1/2"H

1606DHB
Divider
74" H

1617HBC
Basket
17-7/8"W x 18"L x 7-1/2"H

WS-1818DSHC
Dust Shelf
18"W x 18"L

26" D

WS70-SS18ADHC
18" PARTITION
Wall System
shown with Mobile Kit
and optional accessories

WS70-SS36HC
36" PARTITION
Wall System
shown with Mobile Kit
and optional accessories

1635HBC
Basket
17-7/8"W x 36"L x 7-1/2"H

WS-1836DSHC
Dust Shelf
18"W x 36"L

1006DHB
Divider

HBL345C
34-1/2" Clear Label Holder
also available in 3" and 16-1/2"

Ultra Stack & Hang Bins
available on *pg. 5*
Clear Stack & Hang Bins
available on *pg. 20*

Mesh Stack & Hang Bins
available on *pg. 6*

Tip Out Bins
available on *pg. 87*

Tip Out Bin Hanging Bracket
available on *pg. 87*

54" W

INSTANT VISIBILITY, EASY TO CLEAN, ALL WELDED



QTB-LP-BKT
Hanging Bracket for Tip Out Bins
(Available in Beige or Gray)



All Starter and Add-On Units
come standard with Leg Levelers



All Starter and Add-On Units
can be made mobile

Mobilize your units by ordering the following:

- | | |
|---|---|
| <p>Single Sided Starter Kit
2 - WS-SSMOB Bar
2 - WS-MOB Caster Kit</p> | <p>Double Sided Starter Kit
2 - WS-DSMOB Bar
2 - WS-MOB Caster Kit</p> |
| <p>Single Sided Add-On Kit
1 - WS-SSMOB Bar
1 - WS-MOB Caster Kit</p> | <p>Double Sided Add-On Kit
1 - WS-DSMOB Bar
1 - WS-MOB Caster Kit</p> |

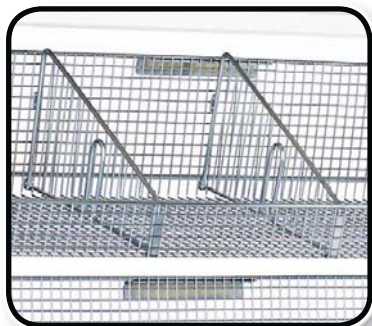
**NEW
BASKET
SIZES****FIRST POSITION**
Flat**SECOND POSITION**
10° slope**THIRD POSITION**
30° slope**ADJUSTABLE BRACKETS
ALLOW YOU TO CHOOSE
YOUR IDEAL POSITION
AND EASIEST ACCESS
TO STORED PRODUCT****COMPLETE
PACKAGES
WITH BASKETS****DIVIDERS**Basket divider allows you to quickly and easily organize the contents of your basket unit by creating separate compartments within each basket
(Sold separately)**WS70-SS36-4S3L**
Shown with dividers
*(Sold separately)***PARTition Wall Systems - Complete Packages**PARTition Wall Hanging Baskets are uniquely designed for instant visibility and easy access while maximizing your storage area. The wire construction minimizes dirt accumulation and allows air circulation. Baskets have a 1/2" x 1/2" grid pattern to partition product while letting you know when to reorder product and restock items. Available in 11-7/8" and 17-7/8" widths, and in 18", 36", and 48" lengths. **Finish:** Chrome

STARTER UNITS		ADD-ON		BASKET		ACCESSORIES		
MODEL NO.	SHIP WGT	MODEL NO.	SHIP WGT	MODEL NO.	NO. OF BASKET	DIVIDER MODEL NO.	LABEL HOLDERS MODEL NO.	DUST SHELF MODEL NO.
18" - Single Sided Systems - Complete with Baskets								
WS70-SS18-7S	83 lbs	WS70-SS18AD-7S	71 lbs	1017HBC	7	1006DHB/1006DHB-SQ	HBL165C	WS-1218DSHC
WS70-SS18-4S3L	86 lbs	WS70-SS18AD-4S3L	86 lbs	1017HBC	4	1006DHB/1006DHB-SQ	HBL165C	WS-1818DSHC
				1617HBC	3	1606DHB/1606DHB-SQ	HBL165C	
36" - Single Sided Systems - Complete with Baskets								
WS70-SS36-7S	117 lbs	WS70-SS36AD-7S	105 lbs	1035HBC	7	1006DHB/1006DHB-SQ	HBL345C	WS-1236DSHC
WS70-SS36-4S3L	123 lbs	WS70-SS36AD-4S3L	111 lbs	1035HBC	4	1006DHB/1006DHB-SQ	HBL345C	WS-1836DSHC
				1635HBC	3	1606DHB/1606DHB-SQ	HBL345C	
48" - Single Sided Systems - Complete with Baskets								
WS70-SS48-7S	131 lbs	WS70-SS48AD-7S	119 lbs	1047HBC	7	1006DHB/1006DHB-SQ	HBL465C	WS-1248DSHC
WS70-SS48-4S3L	140 lbs	WS70-SS48AD-4S3L	128 lbs	1047HBC	4	1006DHB/1006DHB-SQ	HBL465C	WS-1848DSHC
				1647HBC	3	1606DHB/1606DHB-SQ	HBL465C	



Starter Units

Starter units come complete with two uprights and three tie-bars.



WS70-SS18HC WS70-SS36HC WS70-SS48HC

Add-On Units

Add-On units allow you to expand your Starter unit by sharing an upright. Add-On unit includes one common upright and three tie-bars.

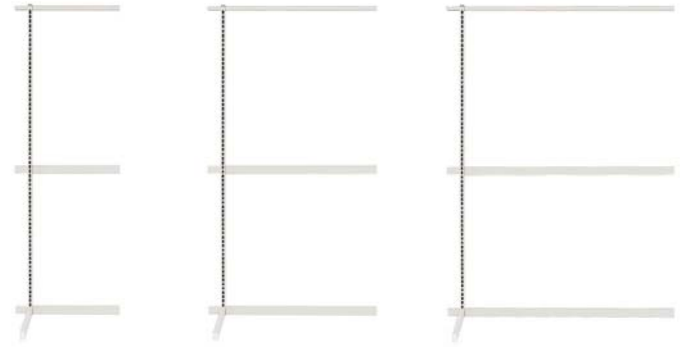

WS70-SS18ADHC WS70-SS36ADHC WS70-SS48ADHC

L"	STARTER UNITS		ADD-ON UNITS		ACCESSORIES				
	MODEL NO.	SHIP WGT	MODEL NO.	SHIP WGT	HANG BAR	12" DUST SHELF	18" DUST SHELF	LOUVERED PANEL	PANEL FRAME*
Single Sided Units									
18"	WS70-SS18HC	31 lbs	WS70-SS18ADHC	31 lbs	-	WS-1218DSHC	WS-1818DSHC	QLP-1861HC	WS-PM18HC
36"	WS70-SS36HC	37 lbs	WS70-SS36ADHC	25 lbs	WS-HB36HC	WS-1236DSHC	WS-1836DSHC	QLP-3661HC	WS-PM36HC
48"	WS70-SS48HC	42 lbs	WS70-SS48ADHC	30 lbs	WS-HB48HC	WS-1248DSHC	WS-1848DSHC	QLP-4861HC	WS-PM48HC
Double Sided Units									
18"	WS70-DS18HC	34 lbs	WS70-DS18ADHC	21 lbs	-	WS-1218DSHC	WS-1818DSHC	QLP-1861HC	WS-PM18HC
36"	WS70-DS36HC	40 lbs	WS70-DS36ADHC	27 lbs	WS-HB36HC	WS-1236DSHC	WS-1836DSHC	QLP-3661HC	WS-PM36HC
48"	WS70-DS48HC	45 lbs	WS70-DS48ADHC	32 lbs	WS-HB48HC	WS-1248DSHC	WS-1848DSHC	QLP-4861HC	WS-PM48HC

*Required to mount louvered panels

CUSTOMIZE YOUR OWN UNIT

For Units using Hanging Brackets:

1. Determine total space you want to fill from left to right
2. Select a Starter Unit (either 18", 36" or 48" wide)
3. Fill remaining space by utilizing Add-On Units
4. Determine how many basket levels you want to have per unit, which will correspond to the total number of brackets needed
5. Dividers and label holders are available for all basket sizes

For Units using Louvered Panels:

1. Determine total space you want to fill from left to right
2. Select a Starter Unit (either 18", 36" or 48" wide)
3. Fill remaining space by utilizing Add-On Units
4. Each unit (both Starter or Add-On) will fit a corresponding 18", 36" or 48" louvered panel (**note:** Louvered panel requires one panel frame)
5. Louvered panel will accommodate:
 - **Hanging Baskets** - available on pg. 114
 - **Clear Tip Out Bins** - available on pg. 87 (**note:** one hanging bracket pair QTBLP-BKT is needed per Tip Out Bin)
 - **Mesh Bins** - available on pg. 6
 - **Plastic Bins** - available on pgs. 5, 20 and 32 (see chart on the bottom of pg. 9 to determine quantity of bins that fit on panel)

Hanging Baskets

- 125 lb. load capacity per basket (up to twice as strong as plastic bins)
- Mesh design ensures no accumulation of dirt or dust and instant visibility
- Brilliant chrome finish ensures professional appearance and years of heavy-duty service
- Baskets can be divided allowing maximization of all space

NEW SIZES

UNIQUELY DESIGNED FOR HIGH VISIBILITY AND EASY ACCESS

MODEL NO.	OUTSIDE DIMENSIONS W" x L" x H"	INSIDE DIMENSIONS W" x L" x H"	SHIP WGT
Hanging Baskets			
1017HBC	11-7/8" x 18" x 7-1/2"	11" x 17-3/8" x 7"	5 lbs
1035HBC	11-7/8" x 36" x 7-1/2"	11" x 35" x 7"	9 lbs
1047HBC (NEW)	11-7/8" x 48" x 7-1/2"	11" x 47" x 7"	11 lbs
1617HBC	17-7/8" x 18" x 7-1/2"	17" x 17-3/8" x 7"	6 lbs
1635HBC	17-7/8" x 36" x 7-1/2"	17" x 35" x 7"	11 lbs
1647HBC (NEW)	17-7/8" x 48" x 7-1/2"	17" x 47" x 7"	14 lbs



WS-DS36HC
Shown with Baskets
(Sold separately)

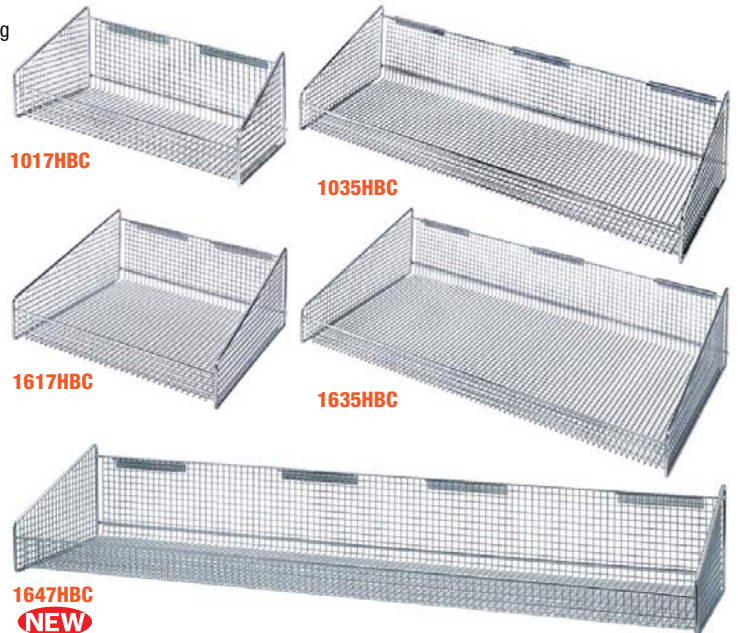



Dividers

6 SIZES AVAILABLE

MODEL NO.	DIMENSIONS W" x H"	SHIP WGT
Hanging Basket Dividers		
4X3HBD NEW	3" x 4-1/2"	1 lb
4X6HBD NEW	6" x 4-1/2"	1 lb
4X9HBD NEW	9" x 4-1/2"	1 lb
4X15HBD NEW	15" x 4-1/2"	2 lbs
1006DHB	10" x 6"	1 lb
1606DHB	16" x 6"	2 lbs
1006DHB-SQ NEW	10" x 6"	1 lb
1606DHB-SQ NEW	16" x 6"	2 lbs

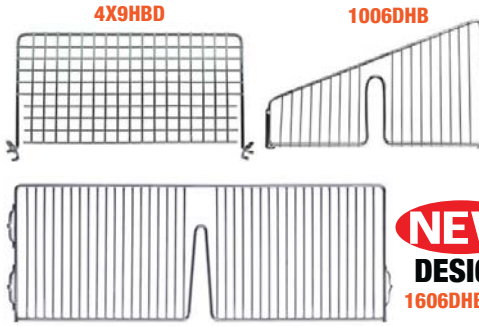

Separate product in basket with use of optional dividers. Dividers are used front to back to create individual compartments.

Clear Label Holders

Super easy method for identifying product. Affixes directly to the front on any basket. Four lengths available. (Label inserts sold separately).

MODEL NO.	DESCRIPTION	SHIP WGT
Clear Label Holders		
HBL3C	3" Clear Label Holder	1 lb
HBL165C	16-1/2" Clear Label Holder Fits 18" Basket	1 lb
HBL345C	34-1/2" Clear Label Holder Fits 36" Basket	1 lb
HBL465C	46-1/2" Clear Label Holder Fits 48" Basket	1 lb



Dust Shelves

WS-1218DSHC

MODEL NO.	DIMENSIONS W" x L"	SHIP WGT
Dust Shelves*		
WS-1218DSHC	12" x 18"	5 lbs
WS-1236DSHC	12" x 36"	10 lbs
WS-1248DSHC	12" x 48"	15 lbs
WS-1818DSHC	18" x 18"	7 lbs
WS-1836DSHC	18" x 36"	15 lbs
WS-1848DSHC	18" x 48"	20 lbs

*Dust Shelves not designed for load bearing

Spikes & Holders

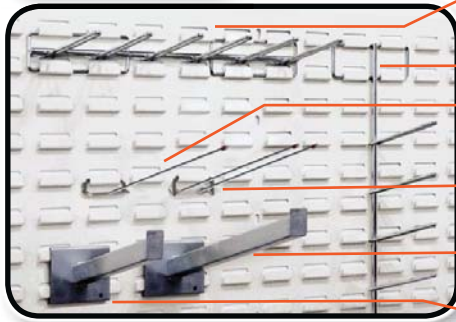

WS-HTH
Horizontal Tape/Reel Holder
25 lb. load capacity

WS-VTH
Vertical Tape/Reel Holder
25 lb. load capacity

WS-SR9C
9" Single Rod
15 lb. load capacity

WS-DR10C
10" Double Rod
15 lb. load capacity

WS-HDS12
Heavy-Duty 12" Spike
50 lb. load capacity

WS-HDS6
Heavy-Duty 6" Spike
65 lb. load capacity



Hanging Brackets

MODEL NO.	DESCRIPTION	SHIP WGT
Hanging Brackets		
WS-HBB	90° Bracket Pair (2 pcs)	1 lb
WS-HBBA	Adjustable Bracket Pair (2 pcs)	1 lb
WS-HBB-D	90° Bracket for Add-On Kit	1 lb
WS-HBBA-D	Adjustable Bracket for Add-On Kit	1 lb

Louvered Panels

MODEL NO.	DIMENSIONS L" x H"	SHIP WGT
Oyster White Louvered Panels		
QLP-1861HC	18" x 61"	21 lbs
QLP-3661HC	36" x 61"	40 lbs
QLP-4861HC	48" x 61"	60 lbs

*Louvered Panels require panel frame in order to affix to PARTition Wall Systems



Hang Bars

Used to mount wire louvered panels on PARTition Wall Systems. Wire Panels available on [pg. 7](#)

MODEL NO.	DESCRIPTION	SHIP WGT
Hang Bars		
WS-HB36HC	36" Hang Bar	4 lbs
WS-HB48HC	48" Hang Bar	5 lbs

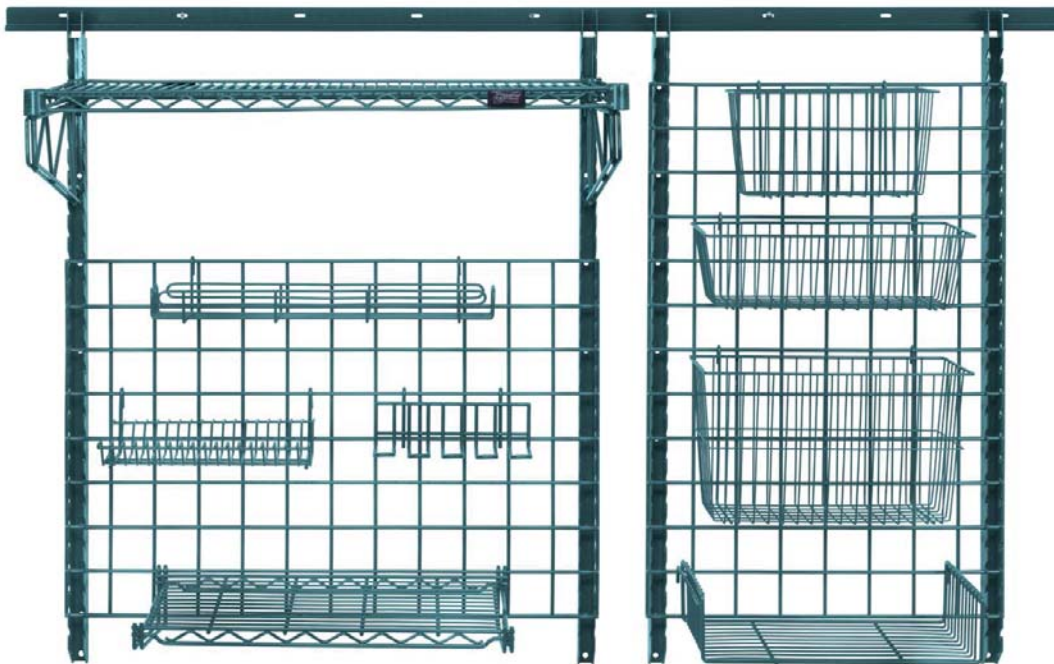

IDEAL FOR MAXIMIZING EFFICIENCY IN ANY PREPARATION, STORAGE OR WORK SPACE

TO ORDER:

1. Select size of smart grid wall tracks
2. Select size and quantity of uprights
3. Select number of shelves and shelf supports (two per shelf)
4. Select grid and accessories

Note: Max capacity varies based on system configuration. Wall track only has a maximum capacity of 250 lbs. when mounted to a wall with wood studs or plywood. Wall track and upright configuration has a maximum configuration of 400 lbs. Capacity is calculated based on system mounted to wood studs or plywood.

Smart Grid Mount System

NEW

A versatile storage, utility and display system suited to maximize efficiencies of underutilized spaces and empty walls. Smart Grid has a sophisticated system that integrates wall tracks, grids, wall shelving and accessories in custom configurations and lengths. The use of the system around and above sinks, prep-stations, work tables, staging areas and equipment will keep these areas cleaner and more organized. Smart Grid enables the flexibility to add wall shelving and wall mounted task stations to any space for ease of accessibility and functionality. The durability of the 15 year warranty antimicrobial epoxy and robust design of the system protects against product degradation and ensures easy installation and maintenance. **Finish:** Proform Green Epoxy

- Keep small wares, utilities, inventory, tools, containers, utensils, and supplies off of the work surface and organized for fast, easy access. The work area remains clean and free from clutter to increase efficiencies.
- Grids attach to the uprights and enable the customizable configurations of accessories - bulk storage shelves, small supply shelves, baskets, hooks, drying rack accessories, utensil holders, bins, small utility racks, and a variety of holders.
- Easy installation and assembly. Mount the wall track and configure a customized work space using uprights, grids, shelves, and accessories.

FLEXIBLE - WALL TRACKS AND UPRIGHTS ARE DESIGNED TO INTERFACE WITH WOOD STUDS, PLYWOOD, CONCRETE, AND OTHER SUITABLE WALL STRUCTURES

Uprights

SG-U16P
Upright
16"

12 gauge cold rolled steel; slotted every 1-1/2"; 1-1/8" diameter mounting holes are spaced every 6" along the upright, sold as eaches. These slots attach to grids and shelf supports in a clip-in function.

MODEL NO.	DESCRIPTION	CTN QTY	CTN WGT
Smart Grid Wall Mount Uprights			
SG-U16P	16" Upright	1	2 lbs
SG-U31P	31" Upright	1	4 lbs
SG-U44P	44-1/2" Upright	1	5 lbs



Wall Tracks

SG-WT56P
Wall Track
56"



12 gauge cold rolled steel; obround mounting holes located at 8" increments; first and last holes are located 4" from the ends of the track; obround hole dimensions (1/8" x 3/4"). Wall tracks include stop fasteners for the ends of the tracks and joiner plates for connecting adjacent tracks. Hardware not included.

MODEL NO.	DESCRIPTION	CTN QTY	CTN WGT
Smart Grid Wall Mount Tracks			
SG-WT40P	40" Wall Track	1	5 lbs
SG-WT56P	56" Wall Track	1	6 lbs
SG-WT72P	72" Wall Track	1	7 lbs

Wire Grids

SG-1860P
Wire Grid
18" x 60"

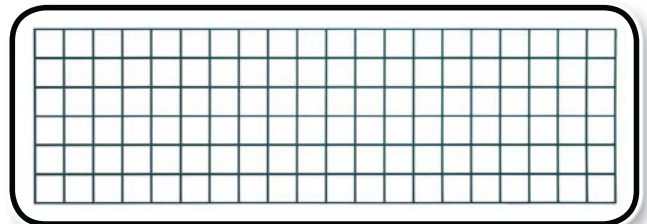

1/4" diameter cold rolled steel wire create with 3" x 3" openings that are easily attached to the uprights.

MODEL NO.	DESCRIPTION	CTN QTY	CTN WGT
Smart Grid Wall Mount Grids			
SG-1830P	18" x 30" Grid	1	8 lbs
SG-1836P	18" x 36" Grid	1	9 lbs
SG-1848P	18" x 48" Grid	1	12 lbs
SG-1860P	18" x 60" Grid	1	14 lbs
SG-2436P	24" x 36" Grid	1	12 lbs
SG-2448P	24" x 48" Grid	1	15 lbs
SG-3036P	30" x 36" Grid	1	13 lbs
SG-3048P	30" x 48" Grid	1	17 lbs
SG-3354P	33" x 54" Grid	1	21 lbs



Smart Grid Accessories



A

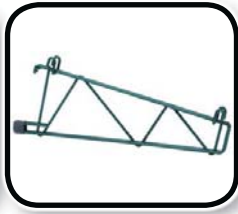

B



C



D



E



F



G



H



I



J



K



L



M



N

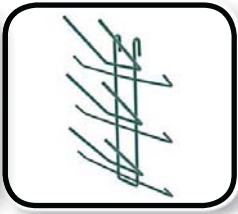

O



P



Q



R

MODEL NO.	DESCRIPTION	CTN QTY	CTN WGT
Accessories			
A*	SG-CS14P 14" Shelf Single Cantilever	1	3 lbs
	SG-CS18P 18" Shelf Single Cantilever	1	3 lbs
	SG-CS21P 21" Shelf Single Cantilever	1	4 lbs
	SG-CS24P 24" Shelf Single Cantilever	1	4 lbs
B*	SG-CD14P 14" Shelf Double Cantilever	1	3 lbs
	SG-CD18P 18" Shelf Double Cantilever	1	3 lbs
	SG-CD21P 21" Shelf Double Cantilever	1	4 lbs
	SG-CD24P 24" Shelf Double Cantilever	1	4 lbs
C	SG-S918P 9" x 18" Shelf with Side Ledge	1	1 lb
D	SG-S1224P 12" x 24" Small Grid Shelf	1	1 lb
E	SG-B1357P 13-3/8" x 5" x 7" Basket	1	9 lbs
F	SG-B1775P 17-3/8" x 7-1/2" x 5" Basket	1	7 lbs
G	SG-B17710P 17-3/8" x 7-1/2" x 10" Basket	1	11 lbs
H	SG-HOOKSM Small Hook	1	1 lb
I	SG-HOOKLG Large Hook	1	1 lb
J	SG-HOOKDB Double Large Hook	1	1 lb
K	SG-HOOK6P 6" Hook	1	1 lb
L	SG-TDR461410P Tray Drying Rack	1	12 lbs
M	SG-SLH201412P Slanted Lid Holder/Drying Shelf	1	5 lbs
N	SG-LH1384P Lid Holder/Drying Shelf	1	2 lbs
O	SG-BR6P 6-Prong Bottle Rack	1	2 lbs
P	SG-UH10P Large Utensil Holder	1	4 lbs
Q	SG-UH4P Small Utensil Holder	1	4 lbs
R	SG-CMBP Cylinder Holder Mounting Bracket	1	1 lb
S	SG-CH Flatware Cylinder	1	1 lb
T	SG-SBH Single Bin Holder	1	1 lb
	SG-SMBH Small Bin Holder	1	1 lb
	SG-LGBH Large Bin Holder	1	2 lbs
U	SG-SR2254P Spice Rack Utility Rack	1	4 lbs
V	SG-IPH Insert Pan Holder Plated	1	2 lbs
W	SG-HFF Hanging File Folder Plated	1	3 lbs
X	SG-GBHP Glove Box Holder	1	2 lbs
Y	SG-BH29P Book Holder 2" x 9"	1	3 lbs
Z	SG-DWB Mounting Bracket Kit For Wall (Pack of 6)	1	2 lbs
AB	SG-PWM Plastic Grid Mounting Bracket Kit For Wall (Pack of 6)	1	2 lbs

*Shelf Cantilevers provide support for Quantum 14", 18", 21" and 24" epoxy shelves. Double Cantilevers are used for a side-by-side configuration.



S



T

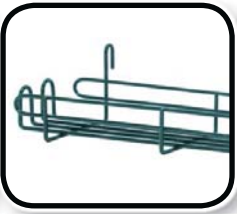

U

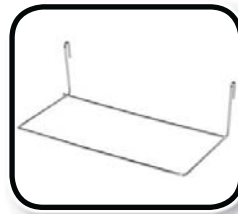

V



W

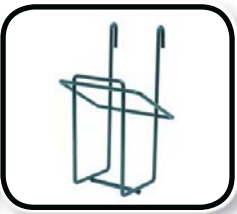

X



Y



Z



AB

**CUSTOMIZABLE CONFIGURATIONS
OF A VARIETY OF ACCESSORIES**



Cantilever Single Shelf Wall Mount

Cantilever shelving is an excellent way to create storage space when floor space isn't available. Simple in design, our cantilever shelving systems are easy to assemble and install. Select from three different depths: 14", 18" or 24". Two cantilever arms and 2 mounting brackets are included per order. Wire shelves are sold separately and are available on **pg. 98**. **Finish:** Chrome, Proform Green and Gray Epoxy

MODEL NO.	DESCRIPTION	SHIP WGT
Chrome Cantilever Arms and Mounting Brackets		
DWB14	2 - 14" Cantilever Arms & 2 Mounting Brackets	3 lbs
DWB18	2 - 18" Cantilever Arms & 2 Mounting Brackets	4 lbs
DWB24	2 - 24" Cantilever Arms & 2 Mounting Brackets	5 lbs
Proform Green Epoxy Cantilever Arms and Mounting Brackets		
DWB14P NEW	2 - 14" Cantilever Arms & 2 Mounting Brackets	3 lbs
DWB18P NEW	2 - 18" Cantilever Arms & 2 Mounting Brackets	4 lbs
DWB24P NEW	2 - 24" Cantilever Arms & 2 Mounting Brackets	5 lbs
Gray Epoxy Cantilever Arms and Mounting Brackets		
DWB14GY NEW	2 - 14" Cantilever Arms & 2 Mounting Brackets	3 lbs
DWB18GY NEW	2 - 18" Cantilever Arms & 2 Mounting Brackets	4 lbs
DWB24GY NEW	2 - 24" Cantilever Arms & 2 Mounting Brackets	5 lbs

Cantilever Multiple Shelf Post Wall Mount Adjustable on 1" increments

Adjustable post wall mount systems use a post cantilever single arm of 14", 18" or 24" with appropriate shelf size and post height. Two post cantilever single arms and 4 post mount brackets are included per order.

Post Cantilever Double Arm is available in 14", 18" and 24" and uses the center post for continuous or add-on shelf sections. One post cantilever double arm and 2 post mount brackets are included per order. Wire shelves and post are sold separately and available on **pgs. 98 & 99**. **Finish:** Chrome, Stainless Steel, Proform Green and Gray Epoxy

MODEL NO.	DESCRIPTION	SHIP WGT
Chrome Single Post Cantilever Arms		
CB14	2 - 14" Single Post Cantilever Arms & 4 Post Mount Brackets	5 lbs
CB18	2 - 18" Single Post Cantilever Arms & 4 Post Mount Brackets	6 lbs
CB24	2 - 24" Single Post Cantilever Arms & 4 Post Mount Brackets	7 lbs
Proform Green Epoxy Single Post Cantilever Arms		
CB14P NEW	2 - 14" Single Post Cantilever Arms & 4 Post Mount Brackets	5 lbs
CB18P NEW	2 - 18" Single Post Cantilever Arms & 4 Post Mount Brackets	6 lbs
CB24P NEW	2 - 24" Single Post Cantilever Arms & 4 Post Mount Brackets	7 lbs
Gray Epoxy Single Post Cantilever Arms		
CB14GY NEW	2 - 14" Single Post Cantilever Arms & 4 Post Mount Brackets	5 lbs
CB18GY NEW	2 - 18" Single Post Cantilever Arms & 4 Post Mount Brackets	6 lbs
CB24GY NEW	2 - 24" Single Post Cantilever Arms & 4 Post Mount Brackets	7 lbs
Stainless Steel Single Post Cantilever Arms		
CB14S NEW	2 - 14" Single Post Cantilever Arms & 4 Post Mount Brackets	5 lbs
CB18S NEW	2 - 18" Single Post Cantilever Arms & 4 Post Mount Brackets	6 lbs
Chrome Double Post Cantilever Arms		
DCB14	1 - 14" Double Post Cantilever Arm & 2 Post Mount Brackets	10 lbs
DCB18	1 - 18" Double Post Cantilever Arm & 2 Post Mount Brackets	12 lbs
DCB24	1 - 24" Double Post Cantilever Arm & 2 Post Mount Brackets	14 lbs
Proform Green Epoxy Double Post Cantilever Arms		
DCB14P NEW	1 - 14" Double Post Cantilever Arm & 2 Post Mount Brackets	10 lbs
DCB18P NEW	1 - 18" Double Post Cantilever Arm & 2 Post Mount Brackets	12 lbs
DCB24P NEW	1 - 24" Double Post Cantilever Arm & 2 Post Mount Brackets	14 lbs
Gray Epoxy Double Post Cantilever Arms		
DCB14GY NEW	1 - 14" Double Post Cantilever Arm & 2 Post Mount Brackets	10 lbs
DCB18GY NEW	1 - 18" Double Post Cantilever Arm & 2 Post Mount Brackets	12 lbs
DCB24GY NEW	1 - 24" Double Post Cantilever Arm & 2 Post Mount Brackets	14 lbs

TURN EMPTY WALLS INTO STORAGE SPACE

AVAILABLE IN CHROME, PROFORM GREEN AND GRAY EPOXY

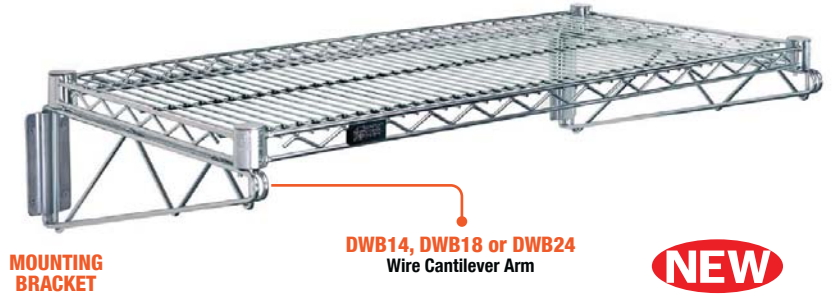

MOUNTING BRACKET

DWB14, DWB18 or DWB24 Wire Cantilever Arm

NEW FINISHES

AVAILABLE IN CHROME, PROFORM GREEN OR GRAY EPOXY AND STAINLESS STEEL

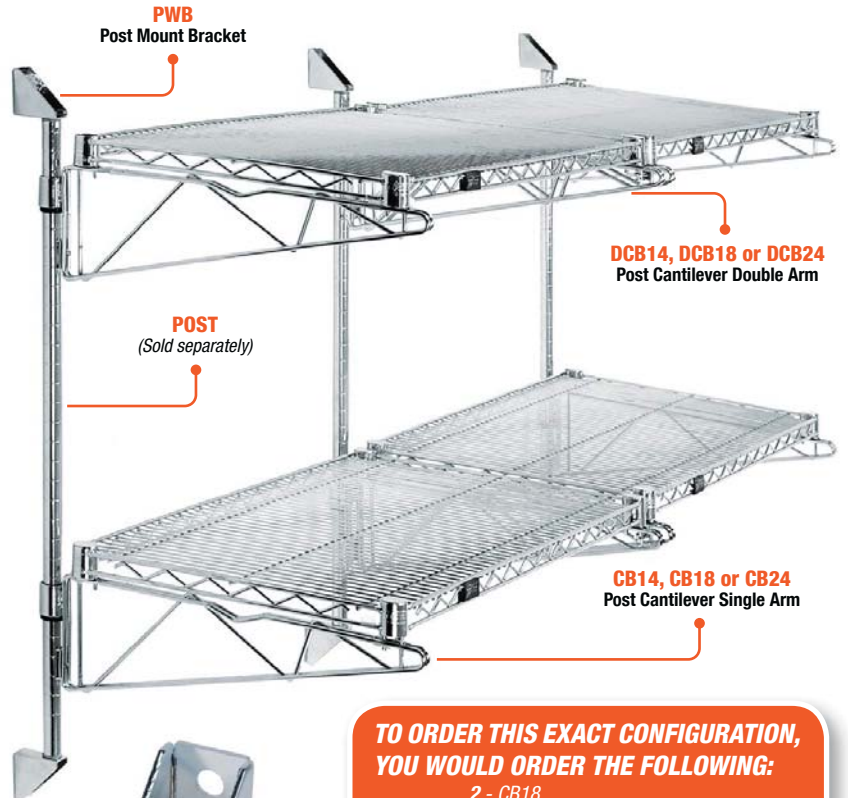

PWB Post Mount Bracket

DCB14, DCB18 or DCB24 Post Cantilever Double Arm

POST (Sold separately)

CB14, CB18 or CB24 Post Cantilever Single Arm



PWB Post Mount Bracket
Used to secure cantilever post mount units and free standing shelving units to wall. Available in Chrome, Stainless Steel, Proform Green, Gray and Black Epoxy. Sold in a pack of 4. (Mounting Screws are not included)

TO ORDER THIS EXACT CONFIGURATION, YOU WOULD ORDER THE FOLLOWING:

- 2 - CB18
- 2 - DCB18
- 4 - 1836C
- 3 - P34C

To further extend the configuration shown by an additional section to the left or right, simply order:

- 2 - DCB18
- 2 - 1836C
- 1 - P34C

To further extend the configuration shown by an additional shelf level, simply order:

- 1 - CB18
- 1 - DCB18
- 2 - 1836C

Your options are unlimited.



Post Wall Mount Cantilever with Bin Rail Holder - Complete Packages

Easy access, adjustable wall mounted bin systems. Available in 36", 48" and 60" widths. Optional bin dividers, windows fronts and clear label holders are available on pg. 5.

MODEL NO.	NO. OF BIN RAILS	DIMENSIONS L" x H"	NO. OF BINS	BIN DIMENSIONS L" x W" x H"	SHIP WGT
Wire Cantilever Bin Holder - Complete with Bins Available in Blue, Green, Ivory, Red, Yellow, Black and Clear					
CAN-34-36BH-230	3	36" x 34"	18 QUS230	10-7/8" x 5-1/2" x 5"	26 lbs
CAN-34-48BH-230	3	48" x 34"	24 QUS230	10-7/8" x 5-1/2" x 5"	34 lbs
CAN-34-60BH-230	3	60" x 34"	30 QUS230	10-7/8" x 5-1/2" x 5"	42 lbs

COMPLETE PACKAGES WITH BINS



CAN-34-36BH-230



CAN-34-60BH-230

Post Wall Mount Cantilever with Baskets - Complete Packages

Modular Wire Baskets mount to standard post to utilize wall space efficiently. Baskets allow for high visibility and quick accessibility. Baskets are adjustable and removable. *Finish: Chrome*

MODEL NO.	NO. OF BASKETS	BASKET MODEL NO.	BASKET DIMENSIONS W" x L" x H"	SHIP WGT
34"H - Wire Cantilever with Baskets - Complete Packages				
CAN-34-1436BC-PWB	2	1436BC	14" x 36" x 9"	26 lbs
CAN-34-1448BC-PWB	2	1448BC	14" x 48" x 9"	32 lbs
CAN-34-2036BC-PWB	2	2036BC	20" x 36" x 9"	30 lbs
CAN-34-2048BC-PWB	2	2048BC	20" x 48" x 9"	36 lbs
CAN-34-203612BC-PWB	2	203612BC	20" x 36" x 12"	34 lbs
CAN-34-204812BC-PWB	2	204812BC	20" x 48" x 12"	38 lbs

COMPLETE PACKAGES WITH BASKETS



COLLAR HOOKS
Baskets connect via collar hooks to post



CAN-34-1436BC-PWB

DIVIDERS AVAILABLE FOR ALL BASKETS

Basket Dividers

Optional dividers can be used to separate product. *Finish: Chrome*

DIVIDER MODEL NO.	DIMENSIONS L" x H"	SHIP WGT
149DC	14" x 9"	1 lb
209DC	20" x 9"	2 lbs
2012DC	20" x 12"	2 lbs



149DC
Shown on Basket

Modular Wire Stacking Baskets

Offer a variety of storage, display, and mobile supply applications. Dividers can be used to separate product. Accessible front and a wide selection of sizes allow for all types of product to be used from storage to display. (Dividers sold separately) **Finish:** Chrome



1436BC
 Shown with Dividers and Clear Label Holder (Sold separately)

CLEAR LABEL HOLDERS
 Super easy method for identifying product. Affix directly to the front on any basket. Available in three lengths. (Sold separately)

MODEL NO.	DESCRIPTION	SHIP WGT
Clear Label Holders		
BLH3C	3" Clear Label Holder	1 lb
BLH14C	14" Clear Label Holder	1 lb
BLH32C	32" Clear Label Holder	1 lb

MODEL NO.	BASKET DIMENSIONS W" x L" x H"	SHIP WGT	DIVIDER MODEL NO.	SHIP WGT
1436BC	14" x 36" x 9"	10 lbs	149DC	1 lb
1448BC	14" x 48" x 9"	13 lbs	149DC	1 lb
2036BC	20" x 36" x 9"	12 lbs	209DC	2 lbs
2048BC	20" x 48" x 9"	15 lbs	209DC	2 lbs
203612BC	20" x 36" x 12"	14 lbs	2012DC	2 lbs
204812BC	20" x 48" x 12"	16 lbs	2012DC	2 lbs



WR5-36MSBA

FOR ALL TYPES OF PRODUCTS



DOLLY BASE

WR5-36MSBA-MOB

80 lb. STACK CAPACITY PER BASKET

800 lb. MOBILE LOAD CAPACITY

Build and stack any combination of baskets for your requirements. Larger baskets must be positioned on the lowest point.

Stationary Stacking Baskets

Order this exact unit **WR5-36MSBA**
 Unit consists of:
 2 - baskets **1436BC**
 2 - dividers **149DC**
 3 - baskets **203612BC**
 3 - dividers **2012DC**

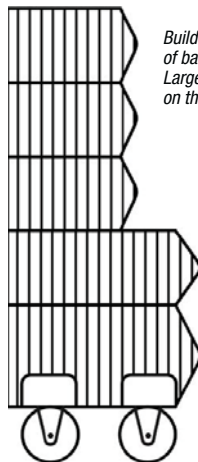

Dolly Base

Includes 4 - 5" x 1-1/4" swivel casters which offer easy transport.

MODEL NO.	DIMENSIONS W" x L"	SHIP WGT
M2036BD	20" x 36"	32 lbs
M2048BD	20" x 48"	34 lbs

Mobile Stacking Baskets

Order this exact unit **WR5-36MSBA-MOB**
 Unit consists of:
 2 - baskets **1436BC**
 2 - dividers **149DC**
 3 - baskets **203612BC**
 3 - dividers **2012DC**
 1 - dolly **M2036BD**



3 BASKET POSITIONS FOR FLEXIBLE STORAGE



ANGLE DOWN
Flows parts to front provides maximum accessibility



FLAT
Provides maximum space efficiency



ANGLED UP
Provides maximum bin capacity

Wire Basket Units

Basket units allow high visibility and air circulation. Baskets act as perfect pick bins which can be added to 18", 21" and 24" deep shelving units. The collar hook allows the basket to be removed or adjusted to accommodate various product mix and sizes. Baskets are adjustable on 1" increments. 150 lb. load capacity per basket. Adjustable baskets used in combination with shelves are an excellent method to store all types of products. Units can be stationary or mobile. Casters add flexibility and convert stationary units into transport systems. Ideal for exchange charts and par level storage. (Dividers sold separately) **Finish:** Chrome



M1836BC6C
(Dividers sold separately)



COLLAR HOOKS
Hooks onto basket corner allowing basket to securely hang.



1836BC6C
(Dividers sold separately)

Mobile Wire Basket Units

Each mobile unit consists of:

- 4 - 63"H posts
- 3 - 9"H adjustable baskets including collar hooks
- 2 - wire shelves
- 4 - donut bumpers
- 4 - swivel 5" x 1-1/4" thermoplastic resin casters, 2 with brakes

MOBILE MODEL NO.	DIMENSIONS W" x L" x H"	NO. OF SHELVES	NO. OF BASKETS	SHIP WGT
M1836BC6C	18" x 36" x 69"	2	3	78 lbs
M1848BC6C	18" x 48" x 69"	2	3	90 lbs
M2436BC6C	24" x 36" x 69"	2	3	93 lbs
M2448BC6C	24" x 48" x 69"	2	3	108 lbs

Stationary Wire Basket Units

Each stationary unit consists of:

- 4 - 63"H posts
- 3 - 9"H adjustable baskets including collar hooks
- 2 - wire shelves

STATIONARY MODEL NO.	DIMENSIONS W" x L" x H"	NO. OF SHELVES	NO. OF BASKETS	SHIP WGT
1836BC6C	18" x 36" x 63"	2	3	70 lbs
1848BC6C	18" x 48" x 63"	2	3	82 lbs
2436BC6C	24" x 36" x 63"	2	3	85 lbs
2448BC6C	24" x 48" x 63"	2	3	100 lbs

COMPLETE PACKAGES WITH BASKETS

Post Baskets

HIGH VISIBILITY, EASY TO CLEAN, ALL-WELDED

Quantum's post baskets are manufactured of industrial grade chrome wire offering a 5/8" x 5/8" mesh design on the bottom/flat surface. Super heavy-duty design affords a generous 600-800 lb. load capacity* evenly distributed. Unique design allows baskets to be used without needing any flat shelves to stabilize overall unit. Drop front and sloped sides provide super easy access while providing a captive space for stored items. Baskets are all adjustable on 1" increments utilizing standard 1" diameter posts. **Finish:** Chrome

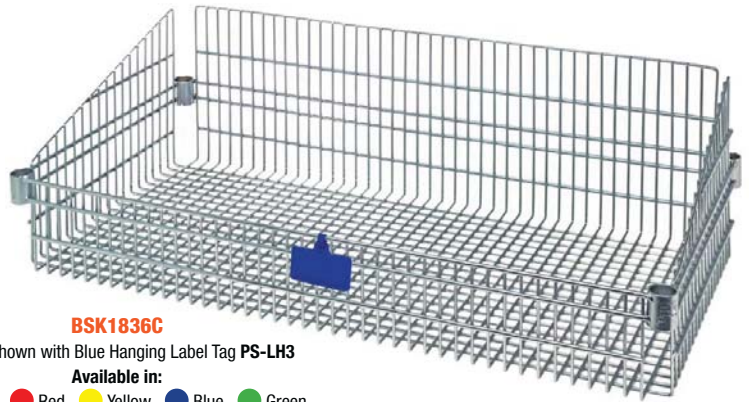

BSK1836C

Basket shown with Blue Hanging Label Tag PS-LH3

Available in:

- Clear
 - Red
 - Yellow
 - Blue
 - Green
 - Orange
 - Pink
 - Purple
- (Sold separately)

MODEL NO.	DIMENSIONS W" x L" x H"	SHIP WGT	DIVIDER MODEL NO.	SHIP WGT
BSK1824C	18" x 24" x 10"	11 lbs	DSK18	2 lbs
BSK1836C	18" x 36" x 10"	13 lbs	DSK18	2 lbs
BSK1848C	18" x 48" x 10"	17 lbs	DSK18	2 lbs
BSK1860C	18" x 60" x 10"	27 lbs	DSK18	2 lbs
BSK2424C	24" x 24" x 10"	12 lbs	DSK24	3 lbs
BSK2436C	24" x 36" x 10"	15 lbs	DSK24	3 lbs
BSK2448C	24" x 48" x 10"	20 lbs	DSK24	3 lbs
BSK2460C	24" x 60" x 10"	34 lbs	DSK24	3 lbs

*24" - 48" wide offer 800 lb. capacity evenly distributed 60" wide offers 600 lb. capacity evenly distributed

Clear Label Holders

A super easy method for identifying product. Affixes directly to the front on any post basket. Available in six lengths. (Label inserts sold separately)

MODEL NO.	DESCRIPTION	SHIP WGT
Clear Label Holders		
BLH3C	3" Clear Label Holder	1 lb
BLH14C	14" Clear Label Holder	1 lb
BLH20C	20" Clear Label Holder	1 lb
BLH32C	32" Clear Label Holder	1 lb
BLH44C	44" Clear Label Holder	1 lb
BLH56C	56" Clear Label Holder	1 lb

COMPLETE CARTS INCLUDE CASTER KIT FOR MOBILITY

1,200 lb. MOBILE LOAD CAPACITY

Mobile 5 Post Basket Units

Each mobile unit consists of:

- 4 - 74" H posts
- 5 - post basket
- 4 - donut bumpers
- 4 - 5" x 1-1/4" swivel thermoplastic resin casters, 2 with brake

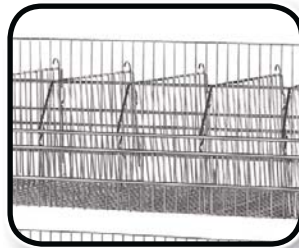

DIVIDERS

Post basket divider allows you to quickly and easily organize the contents of your post basket unit by creating separate compartments within each basket (Sold separately)

MODEL NO.	DIMENSIONS W" x L" x H"	SHIP WGT
WRC74-BSK1824C-5	18" x 24" x 80"	94 lbs
WRC74-BSK1836C-5	18" x 36" x 80"	127 lbs
WRC74-BSK1848C-5	18" x 48" x 80"	160 lbs
WRC74-BSK1860C-5	18" x 60" x 80"	197 lbs
WRC74-BSK2424C-5	24" x 24" x 80"	125 lbs
WRC74-BSK2436C-5	24" x 36" x 80"	158 lbs
WRC74-BSK2448C-5	24" x 48" x 80"	191 lbs
WRC74-BSK2460C-5	24" x 60" x 80"	228 lbs



WRC74-BSK1836C-5



Hanging Label Tags

8 COLORS AVAILABLE

NEW COLORS

New design Hanging Label tab has flat surface on one side to allow for self-adhesive label. Opposite side has a slot for label to be inserted and easily removed or changed as needed. Paper labels are not included. Label tags work with all wire shelves, mesh bins, hanging, stacking and post baskets. Available in 8 colors. Package of 25.

PS-LH3
Hanging Label Tag
Fits 1-3/8" x 3"
Adhesive Label

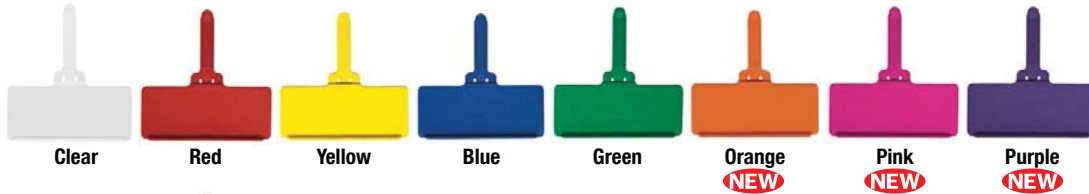

Clear

Red

Yellow

Blue

Green

Orange

Pink

Purple

NEW

NEW

NEW

LHA3C

Shelf Label Holders

Are an excellent method for identifying product. Holders affix directly to truss on any size shelf. (Label inserts sold separately)



EASILY IDENTIFY
PRODUCT ON ANY
SIZE SHELF



LH3C and LH3B Front Shelf View



LHA3C 3 Different Angles

MODEL NO.	DESCRIPTION	SHIP WGT
LH3B	3" Gray Label Holder	1 lb
LH3C	3" Clear Label Holder	1 lb
LH12C	12" Clear Label Holder	1 lb
LH24C	24" Clear Label Holder	1 lb
Full Length Label Holders		
LH33C	33" Clear Label Holder Fits 36" Shelf	1 lb
LH39C	39" Clear Label Holder Fits 42" Shelf	1 lb
LH45C	45" Clear Label Holder Fits 48" Shelf	1 lb
LH51C	51" Clear Label Holder Fits 54" Shelf	2 lbs
LH57C	57" Clear Label Holder Fits 60" Shelf	2 lbs
LH69C	69" Clear Label Holder Fits 72" Shelf	2 lbs
Angled Label Holders - 30°, 60° and 90°		
LHA3C	3" Angled Clear Label Holder	1 lb
LHA5C	5" Angled Clear Label Holder	1 lb
LHA24C	24" Angled Clear Label Holder	1 lb

Stacking & Post Basket Clear Label Holders

A super easy method for identifying product. Affixes directly to the front on any stacking and post basket. Available in six lengths. (Label inserts sold separately)

MODEL NO.	DESCRIPTION	SHIP WGT
Clear Label Holders		
BLH3C	3" Clear Label Holder	1 lb
BLH14C	14" Clear Label Holder	1 lb
BLH20C	20" Clear Label Holder	1 lb
BLH32C	32" Clear Label Holder	1 lb
BLH44C	44" Clear Label Holder	1 lb
BLH56C	56" Clear Label Holder	1 lb



BLH20C
Shown on Basket with Dividers
(Sold separately)

Laser and Inkjet Label Inserts

Laser and inkjet compatible inserts come in 8-1/2" x 11" perforated sheets. Available in 3" and 6" lengths. Multiple inserts can be used on longer label holders. Package of 48 labels.

MODEL NO.	DESCRIPTION	SHIP WGT
Laser and Inkjet Label Inserts - 48 Labels		
LHI-3	1-1/4" x 3" Inserts (3 Sheets)	1 lb
LHI-6	1-1/4" x 6" Inserts (6 Sheets)	1 lb

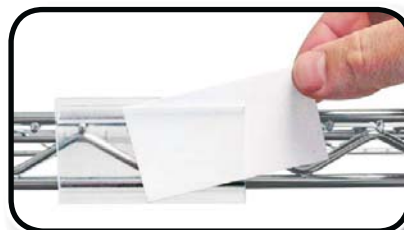

Inserts slide into label holders easily

NEED A LARGER SURFACE AREA FOR IDENTIFICATION?

New generation extended clear label holder clips onto the front snake frame of any wire shelf and offers a 3"H x 5"W label slot with paper insert. Labels can be changed or easily relocated. Laser and inkjet compatible inserts come in 8-1/2" x 11" perforated sheets. Package of 12.



LHE3X5C



Clear Label Holder

Hanging Basket Clear Label Holders

A super easy method for identifying product. Affixes directly to the front on any hanging basket. Available in four lengths. (Label inserts sold separately)

MODEL NO.	DESCRIPTION	SHIP WGT
Clear Label Holders		
HBL3C	3" Clear Label Holder	1 lb
HBL165C	16-1/2" Clear Label Holder	1 lb
HBL345C	34-1/2" Clear Label Holder	1 lb
HBL465C	46-1/2" Clear Label Holder	1 lb



HBL165C



PARTition Store Pull Out Basket Carts

Pull out basket storage organize and transport your storage tools and needed parts.

**800 lb.
MOBILE LOAD CAPACITY**

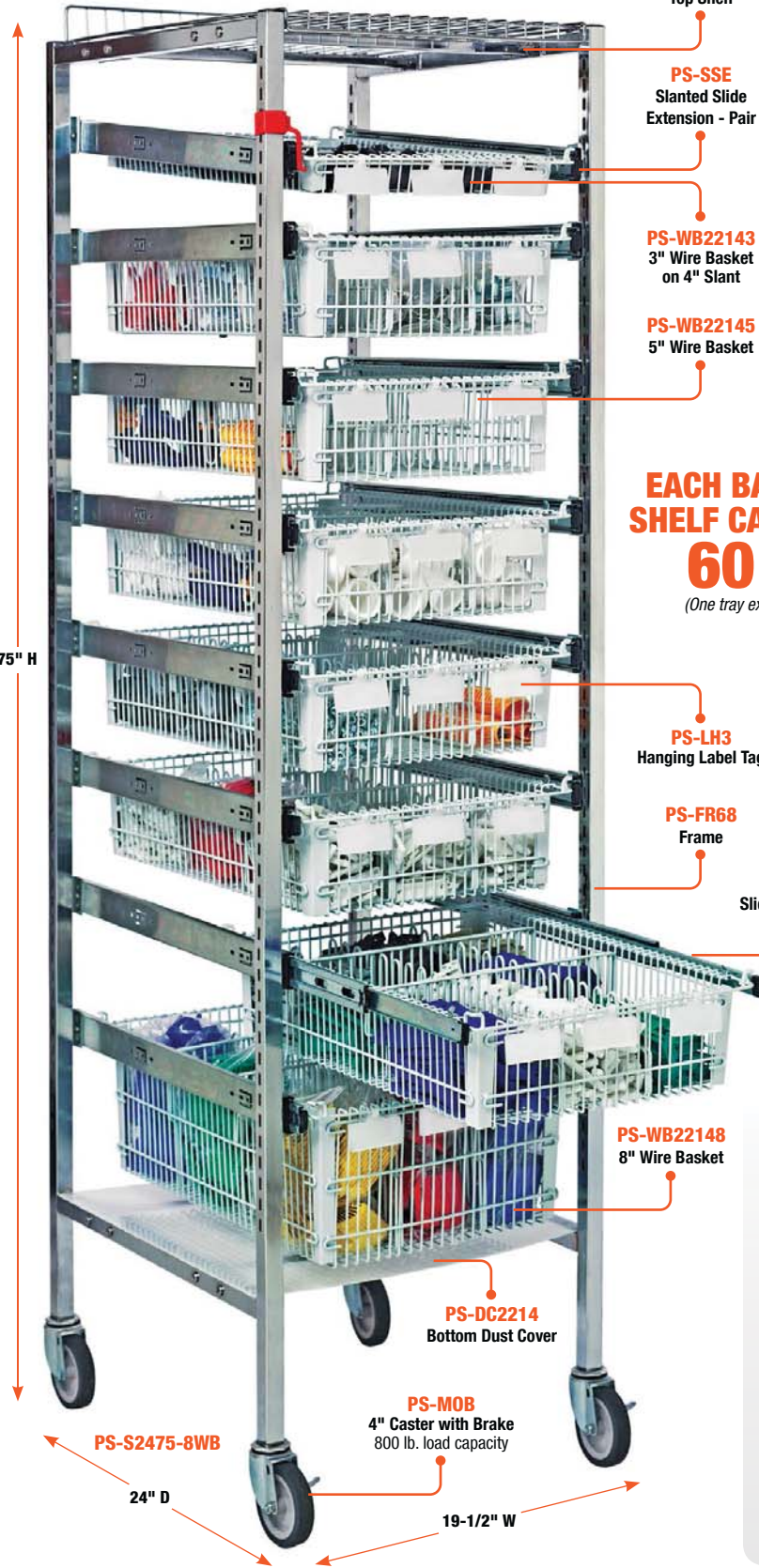

PS-TS22184
Top Shelf

PS-SSE
Slanted Slide Extension - Pair

PS-WB22143
3" Wire Basket on 4" Slant

PS-WB22145
5" Wire Basket

EACH BASKET AND SHELF CAN SUPPORT 60 lbs.
(One tray extended at a time)

PS-LH3
Hanging Label Tag

PS-FR68
Frame

PS-SE
Slide Extension - Pair

PS-WB22148
8" Wire Basket

PS-DC2214
Bottom Dust Cover

PS-MOB
4" Caster with Brake
800 lb. load capacity

PS-S2475-8WB

PARTition Store Starter Unit

Starter units come complete with 2 frames, 4 cross bars, top wire shelf, full extension slides, bottom dust cover and four 4"H poly casters, 2 with brakes. Load capacity of 800 lb.



PS-S2475-8WB
Starter Unit with Wire Baskets

- 24"D x 19-1/2"W x 75"H
- 1 - 3" wire basket with 2 long and 2 short-dividers
- 6 - 5" wire baskets with 2 long and 2 short-dividers
- 1 - 8" wire basket with 2 long and 2 short-dividers
- 1 - safety stop
- 1 - bottom dust cover
- 25 - PS-LH3 clear hanging label tags

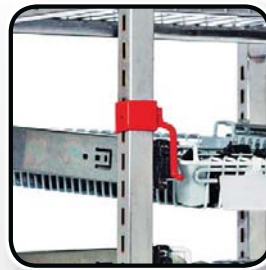

PS-RSS
Red Safety Stop
Used to secure wire baskets from sliding out when used on slanted slide.



PS-LH3
Hanging Label Tag
Fits 1-3/8"H x 3"W adhesive label.
Package of 25. (Sold separately)

- Available in:
- Clear
 - Red
 - Yellow
 - Blue
 - Green
 - Orange
 - Pink
 - Purple



PARTition Store Starter Unit

Starter units come complete with 2 frames, 4 cross bars, top wire shelf, full extension slides, bottom dust cover and four 4"H poly casters, 2 with brakes. Load capacity of 800 lb.



PS-S2475-7S
Starter Unit with Wire Shelves
24"D x 19-1/2"W x 75"H
7 - wire shelves on slides
1 - bottom dust cover
25 - PS-LH3 clear hanging label tags

PARTition Store Single Bay Carts

- Ideal for transport of your needed parts or tools
- All-welded 1" square tubular epoxy-coated steel frame
- Sturdy base with solid shelf
- Heavy-duty 1,200 lb. capacity



PS-SBC58-6WB
Single Bay Cart with Wire Baskets
29-1/2"D x 25"W x 58-1/2"H
1 - 3" wire basket with 2 long and 2 short dividers
4 - 5" wire baskets with 2 long and 2 short dividers
1 - 8" wire basket with 2 long and 2 short dividers
25 - PS-LH3 clear hanging label tags

HEAVY-DUTY PULL OUT BASKET AND SHELF TRANSPORT CARTS



PS-SBC58-6S
Single Bay Cart with Wire Shelves
29-1/2"D x 25"W x 58-1/2"H
6 - wire shelves
25 - PS-LH3 clear hanging label tags

EACH BASKET AND SHELF CAN SUPPORT 60 lbs.

(One tray extended at a time)

1,200 lb. MOBILE LOAD CAPACITY FOR BAY CARTS

PARTition Store Add-On Unit

Add-on units come complete with 1 frame, 4 cross bars, top wire shelf, full extension slides, bottom dust cover and two 4"H casters, 1 with brake.

EXPAND YOUR STARTER UNIT



PS-A2475-8WB
Add-on with Wire Baskets



PS-A2475-7S
Add-on with Wire Shelves

FULL CAPACITY COMPARTMENTS



PS-WB22148
Wire Basket
See *pg. 126* for additional sizes



PS-WS2414
Wire Shelves
Available in White or Chrome Finish



PARTITION Store Double Bay Carts

**1,200 lb.
MOBILE LOAD CAPACITY
FOR BAY CARTS**

- Ideal for transport of your needed parts or tools
- All-welded 1-1/2" square tubular epoxy-coated steel frame
- Sturdy base with solid shelf insert
- 5" quiet poly swivel casters
- Standard donut bumpers on corners which protect walls and provide cushion impact
- Accessories include dividers and label holders
- Custom configurations are available, call for details



PS-DBC-7WB7S

Double Bay Cart with Wire Baskets and Shelves
29-1/2"D x 44"W x 74-1/2"H
7 - 5" wire baskets with 2 long and 2 short dividers
7 - wire shelves on slides
50 - PS-LH3 clear hanging label tags

Also available:
PS-DBC-14WB

Double Bay Cart with Wire Baskets
29-1/2"D x 44"W x 74-1/2"H
14 - 5" wire baskets with 2 long and 2 short dividers
50 - PS-LH3 clear hanging label tags

PS-DBC-14S

Double Bay Cart with Wire Shelves
29-1/2"D x 44"W x 74-1/2"H
14 - wire shelves on slides
50 - PS-LH3 clear hanging label tags

**EACH BASKET AND
SHELF CAN SUPPORT
60 lbs.**

(One tray extended at a time)

**DOUBLE BAY
HEAVY-DUTY
PULL OUT BASKET
TRANSPORT CARTS**

Accessories

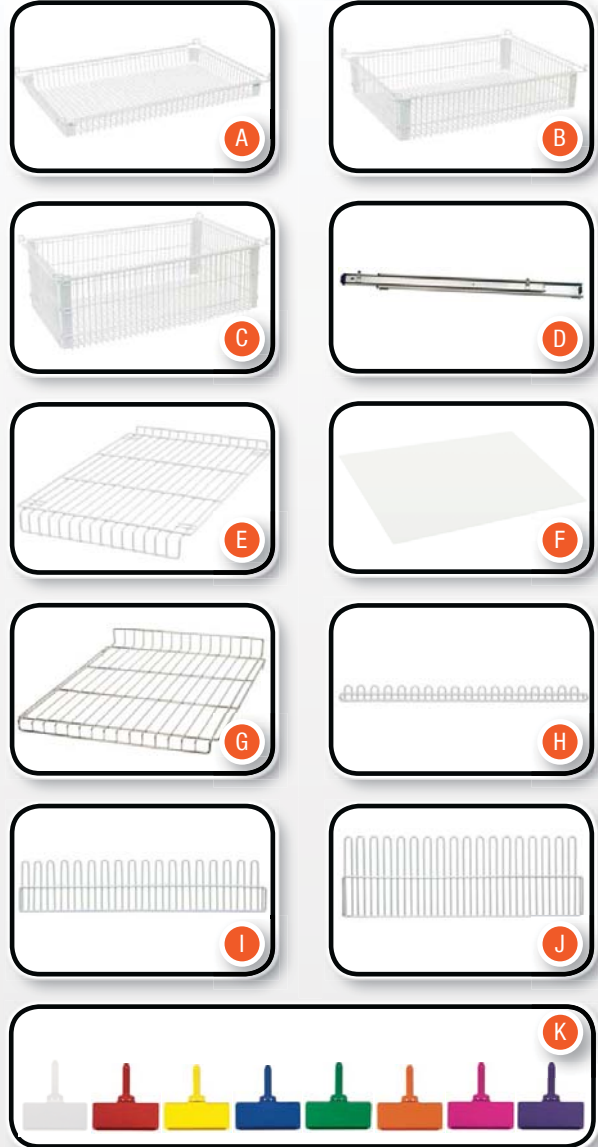

- (A) PS-WB22143**
3" Wire Basket
22" x 14" x 3"
- (B) PS-WB22145**
5" Wire Basket
22" x 14" x 5"
- (C) PS-WB22148**
8" Wire Basket
22" x 14" x 8"
- (D) PS-SE**
Slide Extension - Pair
PS-SSE
Slant Slide Extension - Pair
- (E) PS-WS2414**
Flat Shelf available in:
- White
- Chrome
- (F) PS-DC2214**
Bottom Dust Cover
22" x 14"
- (G) PS-TS22184C**
Chrome Top Shelf
- (H) PS-WBLD-3**
3" Basket Long Divider
PS-WBSD-3
3" Basket Short Divider
- (I) PS-WBLD-5**
5" Basket Long Divider
PS-WBSD-5
5" Basket Short Divider
- (J) PS-WBLD-8**
8" Basket Long Divider
PS-WBSD-8
8" Basket Short Divider
- (K) PS-LH3**
Hanging Label Tag
1-3/8" x 3" Available in:
- Clear - Red - Yellow
- Blue - Green - Orange
- Pink - Purple



1836DS

1836DSGY
NEWNEW
FINISH

ENDURANCE MODEL NO.	GRAY NEW MODEL NO.	DIMENSIONS W" x L"	SHIP WGT
1836DS	1836DSGY	18" x 36"	21 lbs
1848DS	1848DSGY	18" x 48"	28 lbs
1860DS	1860DSGY	18" x 60"	34 lbs
2436DS	2436DSGY	24" x 36"	24 lbs
2448DS	2448DSGY	24" x 48"	30 lbs
2460DS	2460DSGY	24" x 60"	37 lbs

1,300-1,600 lb.
LOAD CAPACITY PER SHELF

Dunnage Shelves

NSF

Dunnage shelves are constructed of 1" square tubular steel with removable wire decking. Utilized in extreme load applications. 1,300-1,600 lb. load capacity depending of shelf length. **Finishes:** Blue Endurance or Gray Epoxy - Excellent for high humidity or corrosive applications and is fortified with an antimicrobial agent.

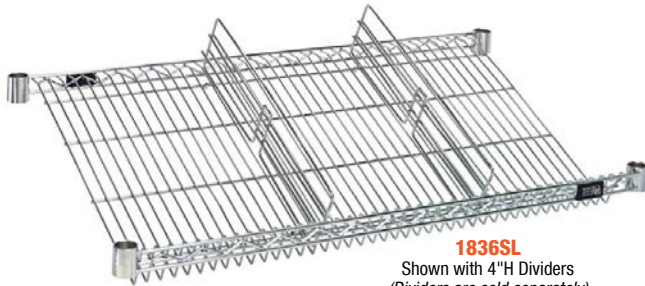
1836SL
Shown with 4"H Dividers
(Dividers are sold separately)

Slanted Shelves

NSF

Designed with a 25° slant to add structure to various applications and retain products. Perfect angle for gravity flow as well as bin storage. **Finish:** Chrome

CHROME MODEL NO.	DIMENSIONS W" x L"	SHIP WGT	DIVIDER MODEL NO.
1836SL	18" x 36"	7 lbs	DIV18SL
1848SL	18" x 48"	8 lbs	DIV18SL
2436SL	24" x 36"	8 lbs	DIV24SL
2448SL	24" x 48"	9 lbs	DIV24SL

TUBULAR FRAME

1836FGY
NEWNEW
FINISH

GRAY NEW MODEL NO.	DIMENSIONS W" x L"	SHIP WGT
1836FGY	18" x 36"	7 lbs
1848FGY	18" x 48"	8 lbs
1860FGY	18" x 60"	9 lbs
2436FGY	24" x 36"	8 lbs
2448FGY	24" x 48"	9 lbs
2460FGY	24" x 60"	10 lbs

Tubular 3 Sided
Frames

NSF

Constructed of 1" square tubing, frame is designed for added structure to the perimeter of a dunnage or shelving unit. **Finish:** Gray Epoxy

SNAKE FRAMES

1836FC
NEW

1836FS

1836FP
NEWNEW
FINISHES

CHROME MODEL NO. NEW	STAINLESS MODEL NO.	PROFORM MODEL NO. NEW	DIMENSIONS W" x L"	SHIP WGT
1836FC	1836FS	1836FP	18" x 36"	6 lbs
1848FC	1848FS	1848FP	18" x 48"	7 lbs
1860FC	1860FS	1860FP	18" x 60"	8 lbs
2436FC	2436FS	2436FP	24" x 36"	8 lbs
2448FC	2448FS	2448FP	24" x 48"	9 lbs
2460FC	2460FS	2460FP	24" x 60"	10 lbs

Wire 3 Sided
Snake Frames

NSF

Designed to add structure to various applications and retain products. **Finishes:** Chrome, 304 Stainless Steel and Proform Green Epoxy

48BH
Shown with QUS220
(Bins are sold separately)

Bin Rail Holders

NSF

Creates a more functional work area with the bin rail which allows you to adapt bins to your shelving unit. Bin rail holder adjusts on 1" increments.

Finish: Chrome

MODEL NO.	DESCRIPTION	SHIP WGT
36BH	One 36" Bin Holder	5 lbs
48BH	One 48" Bin Holder	7 lbs
60BH	One 60" Bin Holder	9 lbs

MODEL NO.	QUS 210	QUS 220	QUS 221	QUS 224	QUS 230
36BH	8	8	5	8	6
48BH	11	11	7	11	8
60BH	14	14	9	14	10

See pg. 5 for bin dimensions

Mobile Dunnage Platform Racks



Units can be used for moving case goods and other heavy items for cleaning, warehouse and stock room applications. Non-marking casters add flexibility. **Finish:** Gray Epoxy

Each unit consists of:

- 4 - 6" posts
- 1 - 3 sided frame
- 1 - dunnage shelf
- 4 - 5" swivel thermoplastic resin casters, 2 with brakes
- 4 - donut bumpers

1,200 lb.
MOBILE LOAD CAPACITY



GRAY NEW MODEL NO.	DIMENSIONS W" x L" x H"	SHIP WGT
M18366DGY	18" x 36" x 12"	36 lbs
M18486DGY	18" x 48" x 12"	44 lbs
M18606DGY	18" x 60" x 12"	51 lbs
M24366DGY	24" x 36" x 12"	40 lbs
M24486DGY	24" x 48" x 12"	47 lbs
M24606DGY	24" x 60" x 12"	55 lbs

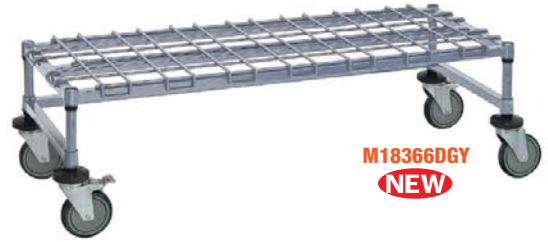

M18366DGY
NEW

Modular Dunnage Racks



Ideal for extreme load capacities (1,300-1,600 lb.). Includes tubular 1" square frame super structure and removable wire top mat. **Finish:** Gray Epoxy

Each unit consists of:

- 4 - 14" posts
- 1 - 3 sided frame
- 1 - dunnage shelf

1,300-1,600 lb.
LOAD CAPACITY



GRAY NEW MODEL NO.	DIMENSIONS W" x L" x H"	SHIP WGT
183614DGY	18" x 36" x 14"	28 lbs
184814DGY	18" x 48" x 14"	36 lbs
186014DGY	18" x 60" x 14"	43 lbs
243614DGY	24" x 36" x 14"	32 lbs
244814DGY	24" x 48" x 14"	39 lbs
246014DGY	24" x 60" x 14"	47 lbs



183614DGY
NEW

Tank & Beverage Container Racks



Represents a cost effective way to keep containers off the floor for cleanliness. This unit is an effective way to tidy up and increase available storage capacity. Used frequently in cafeterias and warehouse applications. **Finish:** Gray Epoxy

Each 1 Tier unit consists of:

- 4 - 34" posts
- 1 - 3 sided frame
- 1 - dunnage shelf

1,300-1,600 lb.
LOAD CAPACITY

Each 2 Tier unit consists of:

- 4 - 54" posts
- 2 - 3 sided frames
- 2 - dunnage shelves

2,600-3,200 lb.
LOAD CAPACITY



GRAY NEW MODEL NO.	DIMENSIONS W" x L" x H"	SHIP WGT
1 Tier		
183634DGY	18" x 36" x 34"	40 lbs
184834DGY	18" x 48" x 34"	48 lbs
186034DGY	18" x 60" x 34"	55 lbs
243634DGY	24" x 36" x 34"	44 lbs
244834DGY	24" x 48" x 34"	51 lbs
246034DGY	24" x 60" x 34"	59 lbs
2 Tier		
183654DGY	18" x 36" x 54"	68 lbs
184854DGY	18" x 48" x 54"	84 lbs
186054DGY	18" x 60" x 54"	98 lbs
243654DGY	24" x 36" x 54"	76 lbs
244854DGY	24" x 48" x 54"	90 lbs
246054DGY	24" x 60" x 54"	106 lbs



183654DGY
NEW

Shelf Platform Racks



Represents an ergonomic solution for keeping case goods off the floor. Platforms are often used at workstations and prep storage areas. **Finish:** Chrome

Each unit consists of:

- 4 - 14" posts
- 1 - shelf

600-800 lb.
LOAD CAPACITY PER SHELF

CHROME MODEL NO.	DIMENSIONS W" x L" x H"	SHIP WGT
183614PC	18" x 36" x 14"	14 lbs
184814PC	18" x 48" x 14"	18 lbs
186014PC	18" x 60" x 14"	21 lbs
243614PC	24" x 36" x 14"	17 lbs
244814PC	24" x 48" x 14"	20 lbs
246014PC	24" x 60" x 14"	25 lbs



183614PC



Polymer Dunnage Racks



Our Dunnage Racks are as portable as they are versatile. Made from lightweight, heavy-duty high density polyethylene, these are the perfect match for wet or chemically intense manufacturing environments. A simple snap together design makes it a breeze to raise finished goods and raw materials off the ground and away from moisture, dirt and traffic. When it comes to cleanup time, just sweep underneath! We offer the largest commercially available sizes in a high-capacity, low-cost dunnage solution that lets you reset and move workstations as often as you see fit. Plus, the grid-top design simplifies working with fluids and bagged goods because any spilled items will flow through the surface to the floor below.



662412DPP



662412DPS

MODEL NO.	DIMENSIONS W" x L" x H"	LOAD CAPACITY	SHIP WGT
Ventilated Top			
362412DPP	24" x 36" x 12"	500 lbs	13 lbs
363612DPP	36" x 36" x 12"	750 lbs	22 lbs
482412DPP	24" x 48" x 12"	700 lbs	19 lbs
662412DPP	24" x 66" x 12"	1,000 lbs	23 lbs
663612DPP	36" x 66" x 12"	1,500 lbs	37 lbs
962412DPP	24" x 96" x 12"	1,400 lbs	34 lbs
963612DPP	36" x 96" x 12"	2,000 lbs	53 lbs
Solid Top			
362412DPS	24" x 36" x 12"	700 lbs	17 lbs
363612DPS	36" x 36" x 12"	1,000 lbs	26 lbs
482412DPS	24" x 48" x 12"	900 lbs	21 lbs
662412DPS	24" x 66" x 12"	1,400 lbs	28 lbs
663612DPS	36" x 66" x 12"	1,900 lbs	49 lbs
962412DPS	24" x 96" x 12"	1,800 lbs	41 lbs
963612DPS	36" x 96" x 12"	2,700 lbs	64 lbs



Expandable EZ Lock Platform Rack & Pallet



Quantum's EZ Lock platform and pallet allows you to customize your storage space in seconds. Its patented interlocking design allows true flexibility in building the exact size pallet or platform you need. Using 12" x 40" footprints, each unit locks together making this an all-purpose storage, moving, and shipping solution. Manufactured of recycled high density polyethylene, the vented deck is freezer safe and chemical resistant. Its one piece body design and structure allows for a 4 way forklift and hand truck entry, and it meets GMA industry standards. Enhances any 5S Lean initiative. Withstands temperatures from -30°F – 200°F and offers a 2,500 lb. load capacity when connected. Once built, the structure will maintain its dimensions with no sagging or stretching. Plastic will not absorb any liquids or chemicals and is resistant to insect infestation. Perfect for use in hospitals, pharmacies, clean rooms, food and beverage areas, manufacturing environments, and supermarket and grocery store back rooms.

EASILY STORE SUPPLIES AND MATERIALS OFF THE GROUND

Available in: ● Black

MODEL NO.	DIMENSIONS W" x L" x H"	CTN QTY	SHIP WGT
EL-12406	12" x 40" x 6"	1 Pair (2 Pieces)	14 lbs

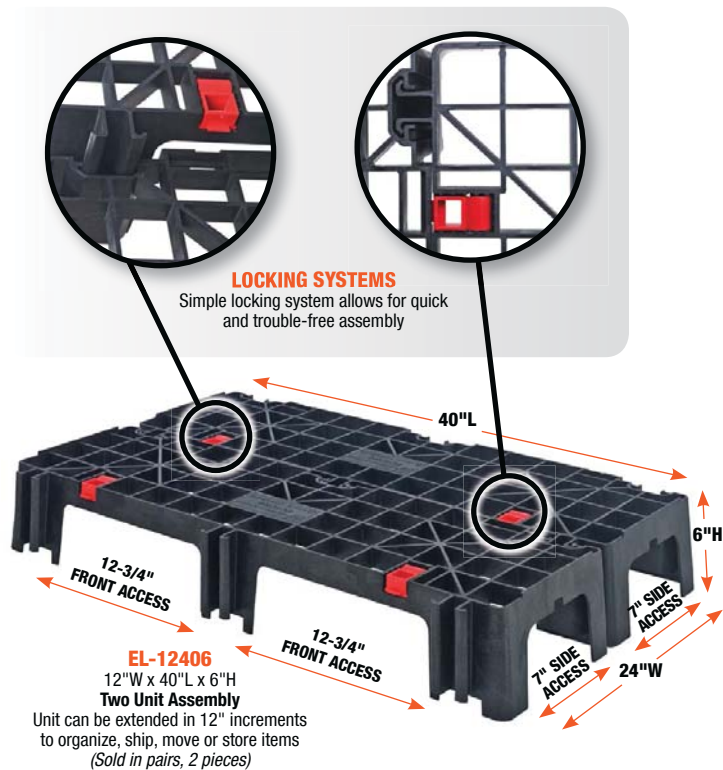

QUICK AND TROUBLE-FREE ASSEMBLY
2,500 LB. LOAD CAPACITY



STACKABLE FOR EASY STORAGE



Work Station Carts - The ideal work-in-process cart

The sloped shelves allow for high visibility, productive rotations and gravity feed. **Cart Finish:** Chrome

Each unit consists of:

- 2 - 34" longer back posts
- 2 - 29" shorter front posts
- 1 - flat wire shelf
- 1 - slanted wire shelf
- 4 - 5" swivel thermoplastic resin casters, 2 with brakes
- 4 - donut bumpers



M1836SL34C
Shown with Bins
(Bins are sold separately)

MOBILE MODEL NO.	SHELF DIMENSIONS W" x L"	NO. OF SHELVES	SHIP WGT
40"H - Work Station Carts			
M1836SL34C	18" x 36"	2	38 lbs
M1848SL34C	18" x 48"	2	48 lbs
M2436SL34C	24" x 36"	2	44 lbs
M2448SL34C	24" x 48"	2	50 lbs



MWRS-5-92060



WRSL6-74-1848-260

NO. OF BINS	BIN DIMENSIONS L" x W" x H"	NO. OF SHELVES	STATIONARY		MOBILE	
			MODEL NO.	SHIP WGT	MODEL NO.	SHIP WGT
18"W x 36"L x 63"H - Wire Shelving System with 2 Flat Shelves and 3 Slanted Shelves Includes Dividable Grid Containers Available in Blue, Gray, Red and Clear						
12	DG92035 16-1/2" x 10-7/8" x 3-1/2"	5	WRS-5-92035	89 lbs	MWRS-5-92035	100 lbs
12	DG92060 16-1/2" x 10-7/8" x 6"	5	WRS-5-92060	96 lbs	MWRS-5-92060	107 lbs
12	DG92080 16-1/2" x 10-7/8" x 8"	5	WRS-5-92080	107 lbs	MWRS-5-92080	118 lbs
18"W x 36"L x 74"H - Wire Shelving System with 2 Flat Shelves and 5 Slanted Shelves Includes Economy Shelf Bins Available in Blue, Green, Ivory, Red, Yellow, Black and Clear						
48	QSB103 17-7/8" x 4-1/8" x 4"	7	WRS-7-103	118 lbs	MWRS-7-103	129 lbs
30	QSB104 17-7/8" x 6-5/8" x 4"	7	WRS-7-104	110 lbs	MWRS-7-104	121 lbs
24	QSB108 17-7/8" x 8-3/8" x 4"	7	WRS-7-108	113 lbs	MWRS-7-108	124 lbs
18	QSB110 17-7/8" x 11-1/8" x 4"	7	WRS-7-110	111 lbs	MWRS-7-110	122 lbs
18"W x 36"L x 74"H - Wire Shelving System with 2 Flat Shelves and 5 Slanted Shelves Includes Euro Drawers Available in Blue, Red, Yellow and Gray						
48	QED604 17-5/8" x 3-3/4" x 4-5/8"	7	WRS-7-604	144 lbs	MWRS-7-604	155 lbs
30	QED602 17-5/8" x 5-9/16" x 4-5/8"	7	WRS-7-602	126 lbs	MWRS-7-602	137 lbs
18	QED606 17-5/8" x 8-3/8" x 4-5/8"	7	WRS-7-606	132 lbs	MWRS-7-606	143 lbs
18"W x 48"L x 74"H - Wire Shelving System with 2 Flat Shelves and 4 Slanted Shelves Includes Ultra Bins Available in Blue, Green, Ivory, Red, Yellow, Black and Clear						
16	QUS260 18" x 11" x 10"	6	WRSL6-74-1848-260	168 lbs	WRCSL6-74-1848-260	179 lbs
24"W x 48"L x 74"H - Wire Shelving System with 2 Flat Shelves and 4 Slanted Shelves Includes Hulk 24" Containers Available in Blue, Red, Yellow and Clear						
16	QUS953 23-7/8" x 11" x 10"	6	WRSL6-74-2448-953	184 lbs	WRCSL6-74-2448-953	195 lbs

Slanted Shelf Carts - Stationary and Mobile

Stationary and Mobile Slanted Shelf units create a unique combination of modular components to enhance supply distribution applications. The sloped shelves allow for high visibility, productive rotations and gravity feed. **(Note: Build a system with your bin requirements or consult a product specialist for appropriate components)**

Each unit consists of:

- 4 - 63" posts
- 2 - flat wire shelves
- 3 - slanted wire shelves

Each mobile unit consists of:

- 4 - 63" posts
- 2 - flat wire shelves
- 3 - slanted wire shelves
- 4 - 5" swivel thermoplastic resin casters, 2 with brakes
- 4 - donut bumpers

63"H - SLANTED SHELF CARTS

SHELF DIMENSIONS W" x L"	NO. OF SHELVES	STATIONARY		MOBILE	
		MODEL NO.	SHIP WGT	MODEL NO.	SHIP WGT
18" x 36"	5	1836SL6C	66 lbs	M1836SL6C	76 lbs
18" x 48"	5	1848SL6C	86 lbs	M1848SL6C	96 lbs
24" x 36"	5	2436SL6C	81 lbs	M2436SL6C	91 lbs
24" x 48"	5	2448SL6C	96 lbs	M2448SL6C	106 lbs

COMPLETE PACKAGES WITH BINS



MWRS-7-104

1,200 lb. MOBILE LOAD CAPACITY



Slanted Shelf with Bin Holders Combo Carts

A systems cart that offers hanging bins, slanted bins and bins on a flat surface all in one unit. Carts offer the ability to store pre-packed items or sloped storage for dispensing small parts. This combination creates a highly customized exchange and storage system. **Cart Finish:** Chrome

Bins available in: ● Blue ● Green ● Ivory ● Red ● Yellow
 ● Black ● Clear (One color per unit)

MODEL NO.	NO. OF SHELVES	NO. OF BINS	BIN DIMENSIONS L" x W" x H"	SHIP WGT
18"W x 36"L x 80"H - Slanted Wire Shelf Cart with Bin Holders and Bins				
WRCSL5-74-1836-104220	5	20 QSB104 24 QUS220	17-7/8" x 6-5/8" x 4" 7-3/8" x 4-1/8" x 3"	105 lbs
WRCSL5-74-1836-104230	5	20 QSB104 18 QUS230	17-7/8" x 6-5/8" x 4" 10-7/8" x 5-1/2" x 5"	112 lbs
18"W x 48"L x 80"H - Slanted Wire Shelf Cart with Bin Holders and Bins				
WRCSL5-74-1848-104220	5	24 QSB104 30 QUS220	17-7/8" x 6-5/8" x 4" 7-3/8" x 4-1/8" x 3"	128 lbs

COMPLETE PACKAGES WITH BINS



WRCSL5-74-1836-104230

Slanted Shelf Carts - Open or Enclosed

Units are designed for quick and easy accessibility for pre-packed items. The wire end panel maintains product while the slanted shelf allows for gravity feed. Available with or without side enclosures. **Cart Finish:** Chrome

OPEN		ENCLOSED	
MODEL NO.	SHIP WGT	MODEL NO.	SHIP WGT
5 Shelf - Slanted Cart 2 Flat Shelves and 3 Slanted Shelves			
WRCSL5-63-1836	76 lbs	WRCSL5-63-1836EP	88 lbs
WRCSL5-63-1848	96 lbs	WRCSL5-63-1848EP	108 lbs
WRCSL5-63-2436	91 lbs	WRCSL5-63-2436EP	105 lbs
WRCSL5-63-2448	106 lbs	WRCSL5-63-2448EP	120 lbs

QUANTUM HAS A NEW ANGLE FOR STORAGE



WRCSL5-63-1836EP



WRCSL5-63-1836-104

1,200 lb. MOBILE LOAD CAPACITY

Dividers, Bin Cups and Clear Label Holders
See pg. 48

Bins available in: ● Blue ● Green ● Ivory ● Red ● Yellow ● Black ● Clear (One color per unit)

		OPEN		ENCLOSED	
NO. OF BINS	BIN DIMENSIONS L" x W" x H"	MODEL NO.	SHIP WGT	MODEL NO.	SHIP WGT
5 Shelf - Slanted Shelf Cart with Bins 2 Flat Shelves and 3 Slanted Shelves					
20 QSB104	17-7/8" x 6-5/8" x 4"	WRCSL5-63-1836-104	94 lbs	WRCSL5-63-1836EP-104	103 lbs
28 QSB104	17-7/8" x 6-5/8" x 4"	WRCSL5-63-1848-104	114 lbs	WRCSL5-63-1848EP-104	123 lbs
20 QSB106	23-5/8" x 6-5/8" x 4"	WRCSL5-63-2436-106	115 lbs	WRCSL5-63-2436EP-106	131 lbs
28 QSB106	23-5/8" x 6-5/8" x 4"	WRCSL5-63-2448-106	136 lbs	WRCSL5-63-2448EP-106	152 lbs

Bin Cart Systems

Bin carts can be used for transporting and holding product. A modular drawer system allows for storage of smaller specialty components while the open shelf design maximizes the storage area. The option of cart covers *pg. 136*, enclosure panels *pg. 146*, ledges and dividers *pg. 147* add to the flexibility of the unit. **Cart Finish:** Chrome

Bins available in: ● Blue ● Red ● Gray ● Clear (One color per unit)

MODEL NO.	NO. OF BINS	BIN DIMENSIONS L" x W" x H"	SHIP WGT
24"W x 36"L x 69"H - Bin Cart with Dividable Grids			
WRC5-63-2436-93060	4 DG93060	22-1/2" x 17-1/2" x 6"	113 lbs
24"W x 48"L x 69"H - Bin Cart with Dividable Grids			
WRC5-63-2448-93060	4 DG93060	22-1/2" x 17-1/2" x 6"	128 lbs
24"W x 60"L x 69"H - Bin Cart with Dividable Grids			
WRC5-63-2460-93060	4 DG93060	22-1/2" x 17-1/2" x 6"	153 lbs

COMPLETE PACKAGES WITH BINS



WRC5-63-2436-93060

- Each unit consists of:
- 4 - 63" posts
 - 5 - wire shelves
 - 4 - DS18-24 bin slides
 - 4 - 5" swivel thermoplastic resin casters, 2 with brake
 - 4 - donut bumpers
 - 4 - DG93060 bins (Blue, Red, Gray or Clear)



1,200 lb. MOBILE LOAD CAPACITY

ALL MOBILE UNITS INCLUDE FOUR 5" x 1-1/4" SWIVEL CASTERS, 2 WITH BRAKES



DIVIDERS

Containers can be divided by length and/or width allowing a subdivision down to a 1-1/8" square compartment size. See *pg. 65*



CLEAR ACRYLIC INLAYS

Keep stored items visible while protecting against airborne dust and other contaminants. Cover lays inside on rim of container. See *pg. 65*

Bin Carts

Offering two heights and four bin quantity designs, these modular carts are the ultimate work-in-process and transport carts. Dividable grids slide easily in and out and with their ability to be divided into multiple compartments with long and short dividers, truly any type of storage is possible, see *pg. 65* for dividers and label holders. **Cart Finish:** Chrome

Bins available in: ● Blue ● Red ● Gray ● Clear (One color per unit)

MODEL NO.	NO. OF BINS	BIN DIMENSIONS L" x W" x H"	SHIP WGT
21"W x 24"L x 45"H - Bin Cart with Dividable Grid Containers			
BC212434M1	4 DG93060	22-1/2" x 17-1/2" x 6"	58 lbs
BC212439M2	7 DG93030	22-1/2" x 17-1/2" x 3"	79 lbs
21"W x 24"L x 69"H - Bin Cart with Dividable Grid Containers			
BC212469M1	7 DG93060	22-1/2" x 17-1/2" x 6"	107 lbs
BC212469M2	11 DG93030	22-1/2" x 17-1/2" x 3"	111 lbs
21"W x 24"L x 45"H - Bin Cart with No Dividable Grid Containers			
BC212439M4	No Containers (includes slides for 4 bin levels)		46 lbs
BC212439M7	No Containers (includes slides for 7 bin levels)		55 lbs
21"W x 24"L x 69"H - Bin Cart with No Dividable Grid Containers			
BC212469M	No Containers (includes slides for 7 bin levels)		63 lbs
BC212469M11	No Containers (includes slides for 11 bin levels)		75 lbs
One Pair - 24" Wire Bin Slides			
WR-S24W	-	-	3 lbs



BC212434M1



BC212469M1



CLEAR BINS AVAILABLE VIEW



BC214069M1D

Double & Triple Bay Bin Carts

Offering double or triple bays and four bin quantity designs, these modular carts are the ultimate work-in-process and transport carts. Dividable grids slide easily in and out and with their ability to be divided into multiple compartments with long and short dividers, truly any type of storage is possible, see pg. 65 for dividers and label holders. Bins can be covered by using our clear acrylic inlays, see below. **Cart Finish:** Chrome

1,200 lb. MOBILE LOAD CAPACITY

Double Bay Bin Carts

Bins available in: Blue Red Gray Clear (One color per unit)

MODEL NO.	NO. OF BINS	BIN DIMENSIONS L" x W" x H"	SHIP WGT
24"W x 40"L x 69"H - Bin Cart with Dividable Grid Containers			
BC214069M1D	14 DG93060	22-1/2" x 17-1/2" x 6"	163 lbs
BC214069M2D	22 DG93030	22-1/2" x 17-1/2" x 3"	164 lbs
24"W x 40"L x 69"H - Bin Cart with No Dividable Grid Containers			
BC214069M14D	No Containers (includes slides for 14 bin levels)		75 lbs
BC214069M22D	No Containers (includes slides for 22 bin levels)		91 lbs
One Pair - 24" Wire Single Bin Slides			
WR-S24W	-	-	3 lbs
One - 24" Wire Double Bin Slide			
WR-D24W	-	-	2 lbs

COMPLETE PACKAGES WITH BINS



DIVIDERS

Containers can be divided by length and/or width allowing a subdivision down to a 1-1/8" square compartment size. See pg. 65



CLEAR ACRYLIC INLAYS

Keep stored items visible while protecting against airborne dust and other contaminants. Cover lays inside on rim of container. See pg. 65

1,200 lb. MOBILE LOAD CAPACITY

Triple Bay Bin Carts

Bins available in: Blue Red Gray Clear (One color per unit)

MODEL NO.	NO. OF BINS	BIN DIMENSIONS L" x W" x H"	SHIP WGT
24"W x 60"L x 69"H - Bin Cart with Dividable Grid Containers			
BC216069M1T	21 DG93060	22-1/2" x 17-1/2" x 6"	233 lbs
BC216069M2T	33 DG93030	22-1/2" x 17-1/2" x 3"	234 lbs
24"W x 60"L x 69"H - Bin Cart with No Dividable Grid Containers			
BC216069M21T	No Containers (includes slides for 21 bin levels)		100 lbs
BC216069M33T	No Containers (includes slides for 33 bin levels)		124 lbs
One Pair - 24" Wire Single Bin Slides			
WR-S24W	-	-	3 lbs
One - 24" Wire Double Bin Slide			
WR-D24W	-	-	2 lbs



BC216069M2T

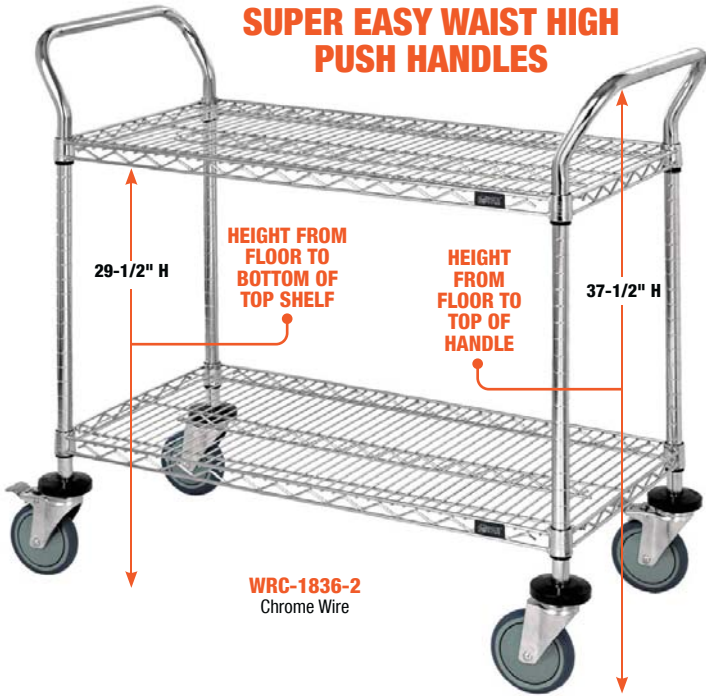

SUPER EASY WAIST HIGH PUSH HANDLES

29-1/2" H
HEIGHT FROM FLOOR TO BOTTOM OF TOP SHELF
37-1/2" H
HEIGHT FROM FLOOR TO TOP OF HANDLE

WRC-1836-2
Chrome Wire

**Cylinder Transport/
Inhalation Therapy Cart**

Mobile unit can transport up to 12 of the D and/or E cylinders. Protective vinyl coated wires separate and protect cylinders. Unit consists of two u-handles, 4 donut bumpers, 4 conductive swivel casters (2 with brakes), 1 wire shelf and 2 frames with coated wire grid shelf.
Wire Finish: Chrome



MODEL NO. SHIP WGT
Mobile Cylinder Cart
18"W x 24"L x 37-1/2"H
WRC-IT1824 45 lbs

WRC-IT1824
(Cylinders not included)

1,200 lb.
MOBILE LOAD CAPACITY



WRC-1836-2CG
Chrome Wire and Solid Galvanized



WRSC-1836-3SS
Solid Stainless Steel



WRC-1836BK-3
Black Epoxy Wire

Wire Utility Carts

UTILITY CARTS
IN ANY STYLE, FINISH, OR CONFIGURATION

Give versatility to any operation: food service, hospitals and maintenance. Carts consists of 2 u-handles, 4 donut bumpers, 4 swivel casters (2 with brakes) and wire or solid shelf combinations.

DIMENSIONS W" x L" x H"	WIRE SHELF					SHIP WGT	WIRE & SOLID SHELF			SOLID SHELF		
	CHROME MODEL NO.	STAINLESS MODEL NO.	PROFORM GREEN EPOXY MODEL NO.	GRAY EPOXY MODEL NO.	BLACK EPOXY MODEL NO.		CHROME MODEL NO.	STAINLESS MODEL NO.	SHIP WGT	GALVANIZED MODEL NO.	STAINLESS MODEL NO.	SHIP WGT
	2 Wire Shelf Mobile Utility Cart						1 Wire and 1 Solid Shelf Mobile Utility Cart			2 Solid Shelf Mobile Utility Cart		
18" x 36" x 37-1/2"	WRC-1836-2	WRSC-1836-2	WRC-1836P-2	WRC-1836GY-2	WRC-1836BK-2	30 lbs	WRC-1836-2CG	WRSC-1836SS-2S	37 lbs	WRC-1836-2G	WRSC-1836-2SS	44 lbs
18" x 42" x 37-1/2"	WRC-1842-2	WRSC-1842-2	WRC-1842P-2	WRC-1842GY-2	WRC-1842BK-2	32 lbs	WRC-1842-2CG	WRSC-1842SS-2S	41 lbs	WRC-1842-2G	WRSC-1842-2SS	50 lbs
18" x 48" x 37-1/2"	WRC-1848-2	WRSC-1848-2	WRC-1848P-2	WRC-1848GY-2	WRC-1848BK-2	37 lbs	WRC-1848-2CG	WRSC-1848SS-2S	45 lbs	WRC-1848-2G	WRSC-1848-2SS	56 lbs
24" x 36" x 37-1/2"	WRC-2436-2	WRSC-2436-2	WRC-2436P-2	WRC-2436GY-2	WRC-2436BK-2	36 lbs	WRC-2436-2CG	WRSC-2436SS-2S	42 lbs	WRC-2436-2G	WRSC-2436-2SS	48 lbs
24" x 42" x 37-1/2"	WRC-2442-2	WRSC-2442-2	WRC-2442P-2	WRC-2442GY-2	WRC-2442BK-2	40 lbs	WRC-2442-2CG	WRSC-2442SS-2S	47 lbs	WRC-2442-2G	WRSC-2442-2SS	54 lbs
24" x 48" x 37-1/2"	WRC-2448-2	WRSC-2448-2	WRC-2448P-2	WRC-2448GY-2	WRC-2448BK-2	44 lbs	WRC-2448-2CG	WRSC-2448SS-2S	52 lbs	WRC-2448-2G	WRSC-2448-2SS	60 lbs
	3 Wire Shelf Mobile Utility Cart						2 Wire and 1 Solid Shelf Mobile Utility Cart			3 Solid Shelf Mobile Utility Cart		
18" x 36" x 37-1/2"	WRC-1836-3	WRSC-1836-3	WRC-1836P-3	WRC-1836GY-3	WRC-1836BK-3	37 lbs	WRC-1836-3CG	WRSC-1836SS-3S	46 lbs	WRC-1836-3G	WRSC-1836-3SS	60 lbs
18" x 42" x 37-1/2"	WRC-1842-3	WRSC-1842-3	WRC-1842P-3	WRC-1842GY-3	WRC-1842BK-3	42 lbs	WRC-1842-3CG	WRSC-1842SS-3S	49 lbs	WRC-1842-3G	WRSC-1842-3SS	68 lbs
18" x 48" x 37-1/2"	WRC-1848-3	WRSC-1848-3	WRC-1848P-3	WRC-1848GY-3	WRC-1848BK-3	48 lbs	WRC-1848-3CG	WRSC-1848SS-3S	52 lbs	WRC-1848-3G	WRSC-1848-3SS	76 lbs
24" x 36" x 37-1/2"	WRC-2436-3	WRSC-2436-3	WRC-2436P-3	WRC-2436GY-3	WRC-2436BK-3	49 lbs	WRC-2436-3CG	WRSC-2436SS-3S	55 lbs	WRC-2436-3G	WRSC-2436-3SS	67 lbs
24" x 42" x 37-1/2"	WRC-2442-3	WRSC-2442-3	WRC-2442P-3	WRC-2442GY-3	WRC-2442BK-3	55 lbs	WRC-2442-3CG	WRSC-2442SS-3S	62 lbs	WRC-2442-3G	WRSC-2442-3SS	76 lbs
24" x 48" x 37-1/2"	WRC-2448-3	WRSC-2448-3	WRC-2448P-3	WRC-2448GY-3	WRC-2448BK-3	60 lbs	WRC-2448-3CG	WRSC-2448SS-3S	68 lbs	WRC-2448-3G	WRSC-2448-3SS	84 lbs



LOWEST PRICE GUARANTEED

Modular Trays



Heavy-duty 18" x 26" white trays are NSF approved and can be used in any application. Perimeter ends are reinforced for additional strength. 20" x 26" size offers a deep stacking tray. Both tray sizes are available in ESD material complying to ANSI/ESD standards for the use in PC board assembly and handling. All trays are manufactured from fiberglass reinforced thermoset material, allowing up to 200 lb. weight capacity when evenly distributed. Quantum's modular trays will withstand temperatures of -40°F to +350°F. 18" x 26" Trays available in White and ESD, 20" x 26" Trays are available in Gray, White and ESD.

Available in: ● Gray ○ White ● Black (ESD)

MODEL NO.	DIMENSIONS W" x L" x H"	SHIP WGT
18" x 26" - Trays		
1826TR	18" x 26" x 1-1/8" White Tray	4 lbs
1826ESD	18" x 26" x 1-1/8" Black ESD Tray	4 lbs
20" x 26" - Stackable Trays		
2026TRGY	20" x 26" x 1-1/2" Gray Tray	5 lbs
2026TRWT	20" x 26" x 1-1/2" White Tray	5 lbs
2026ESD	20" x 26" x 1-1/2" Black ESD Tray	5 lbs



Tray Slides



Efficiently utilize space between shelves using standard trays and/or bins.

- Available in 18" and 24" depths, overall height 23"
- Accommodates up to 10 trays

MODEL NO.	DESCRIPTION	SHIP WGT
Tray Slide		
TS18C	18" Tray Slide Set	10 lbs
TS24C	24" Tray Slide Set	11 lbs



Modular Tray Carts

200 lb. LOAD CAPACITY PER TRAY

Tray Carts are offered in half size and full size units, designed to handle work in process. ESD trays can be used on tray cart for conductive applications with the addition of conductive plastic split sleeves (WR-SSCO) and a drag chain (ESD-DC). Optional Tray Stop prevents trays from falling out. **Cart Finish:** Chrome

MODEL NO.	DIMENSIONS W" x L" x H"	SHIP NO. OF TRAY WGT	TRAY MODEL NO.	TRAY STOP MODEL NO.
39"H - Side Load Tray Cart				
TC-19	18" x 30" x 39"	45 lbs 19	1826ESD 1826TR	TS32C
69"H - Side Load Tray Carts				
TC-39	18" x 30" x 69"	74 lbs 39	1826ESD 1826TR	TS62C
TC-31	21" x 30" x 69"	68 lbs 31	2026ESD 2026TR	TS62C
69"H - End Load Tray Cart				
TC-EL38	21-3/4" x 27" x 69"	74 lbs 38	1826ESD 1826TR	TS62C

Trays are sold separately



TC-19 + 1826TR
(Trays sold separately)



TC-EL38 + 1826TR
End Load Cart
(Trays sold separately)



TC-39 + 1826ESD
Side Load Cart
Tray Stops can be used on back as shown here or one in the back and one in the front.
(Trays sold separately)



Conductive Options

WR-00CO
Conductive Casters
4 swivel
- 2 brakes
- 2 non-brakes



ESD-DC
Drag Chain



WR-SSCO
Plastic Conductive Split Sleeve

Cart Covers

Protect against pilferage, airborne dust, water, and other contaminants. Velcro and zipper flap are available in clear-vinyl and blue and white denier nylon fabric. Clear vinyl is 10 gauge. Blue and white nylon fabric is 400 Denier. Specify zipper or velcro for closure.

CART COVERS OPTIONS AVAILABLE

- Custom sizes
- Hand openings
- Handle holes/slits
- Bottom tie tapes (attach to posts)
- Extra velcro strips
- Double flap
- Clear front flap
- Metal grommets
- 9" x 12" pocket/document holder
- Custom logos

TO ORDER:

1. Choose size
2. Select color:
Clear Vinyl add suffix CV
Blue Nylon add suffix BN
White Nylon add suffix WN
3. Choose Zipper or Velcro



CLEAR VINYL

COVERS PROTECT AGAINST PILFERAGE, AIRBORNE DUST, MOISTURE AND OTHER CONTAMINANTS

CUSTOM SIZES AND ADDITIONAL COLORS ALONG WITH ESD/CONDUCTIVE MATERIAL AVAILABLE

call for details



BLUE NYLON



WHITE NYLON

63"H - CART COVER				74"H - CART COVER			
DIMENSIONS W" x L" x H"	SHIP WGT	400 DENIER MODEL NO.	CLEAR VINYL MODEL NO.	DIMENSIONS W" x L" x H"	SHIP WGT	400 DENIER MODEL NO.	CLEAR VINYL MODEL NO.
18" x 36" x 63"	3 lbs	CC183663	CC183663CV	18" x 36" x 74"	4 lbs	CC183674	CC183674CV
18" x 48" x 63"	4 lbs	CC184863	CC184863CV	18" x 48" x 74"	5 lbs	CC184874	CC184874CV
18" x 60" x 63"	5 lbs	CC186063	CC186063CV	18" x 60" x 74"	6 lbs	CC186074	CC186074CV
18" x 72" x 63"	6 lbs	CC187263	CC187263CV	18" x 72" x 74"	7 lbs	CC187274	CC187274CV
24" x 36" x 63"	3 lbs	CC243663	CC243663CV	24" x 36" x 74"	4 lbs	CC243674	CC243674CV
24" x 48" x 63"	4 lbs	CC244863	CC244863CV	24" x 48" x 74"	5 lbs	CC244874	CC244874CV
24" x 60" x 63"	5 lbs	CC246063	CC246063CV	24" x 60" x 74"	6 lbs	CC246074	CC246074CV
24" x 72" x 63"	6 lbs	CC247263	CC247263CV	24" x 72" x 74"	7 lbs	CC247274	CC247274CV



Stem Caster Carts

4 or 5 Wire Shelf Mobile Carts

Mobile wire stem caster carts add versatility and flexibility to any operation, creating a transport system.

- Supply and distribution
- Stock rotation
- Laundry
- Staging

Each unit consists of:

- 4 - posts
- 4 or 5 - wire shelves
- 4 - donut bumpers
- 4 - 5" thermoplastic resin casters, 2 with brakes

3 or 4 Wire/1 Solid Shelf Mobile Carts

Stem caster cart with solid bottom shelf. The unique combination of wire and solid shelves allows for air circulation and high visibility. The solid shelf in the bottom position prevents dust and dirt to rise and contains spillage.

Each unit consists of:

- 4 - posts
- 3 or 4 - wire shelves
- 1 - solid shelf
- 4 - donut bumpers
- 4 - 5" thermoplastic resin casters, 2 with brakes

1,200 lb. MOBILE LOAD CAPACITY

4 or 5 Solid Shelf Mobile Carts

Stem caster solid shelf cart is an easy way to transport tools and inventories.

Each unit consists of:

- 4 - posts
- 4 or 5 - solid shelves
- 4 - donut bumpers
- 4 - 5" thermoplastic resin casters, 2 with brakes



M1836C46

CHROME WIRE SHELVES

DIMENSIONS W" x L" x H"	4 SHELF CARTS		5 SHELF CARTS	
	MODEL NO.	SHIP WGT	MODEL NO.	SHIP WGT
63"H - Post, 5" Stem Caster Carts				
18" x 36" x 69"	M1836C46	68 lbs	M1836C46-5	72 lbs
18" x 48" x 69"	M1848C46	76 lbs	M1848C46-5	84 lbs
18" x 60" x 69"	M1860C46	97 lbs	M1860C46-5	107 lbs
24" x 36" x 69"	M2436C46	80 lbs	M2436C46-5	87 lbs
24" x 48" x 69"	M2448C46	94 lbs	M2448C46-5	102 lbs
24" x 60" x 69"	M2460C46	116 lbs	M2460C46-5	127 lbs
74"H - Post, 5" Stem Caster Carts				
18" x 36" x 80"	M1836C47	70 lbs	M1836C47-5	74 lbs
18" x 48" x 80"	M1848C47	78 lbs	M1848C47-5	86 lbs
18" x 60" x 80"	M1860C47	99 lbs	M1860C47-5	109 lbs
24" x 36" x 80"	M2436C47	82 lbs	M2436C47-5	89 lbs
24" x 48" x 80"	M2448C47	96 lbs	M2448C47-5	104 lbs
24" x 60" x 80"	M2460C47	118 lbs	M2460C47-5	129 lbs



M1836CG46-5

CHROME WIRE AND 18 GAUGE SOLID GALVANIZED STEEL SHELVES

DIMENSIONS W" x L" x H"	4 SHELF CARTS		5 SHELF CARTS	
	MODEL NO.	SHIP WGT	MODEL NO.	SHIP WGT
63"H - Post, 5" Stem Caster Carts				
18" x 36" x 69"	M1836CG46	68 lbs	M1836CG46-5	78 lbs
18" x 48" x 69"	M1848CG46	76 lbs	M1848CG46-5	90 lbs
18" x 60" x 69"	M1860CG46	97 lbs	M1860CG46-5	114 lbs
24" x 36" x 69"	M2436CG46	80 lbs	M2436CG46-5	93 lbs
24" x 48" x 69"	M2448CG46	94 lbs	M2448CG46-5	110 lbs
24" x 60" x 69"	M2460CG46	116 lbs	M2460CG46-5	137 lbs
74"H - Post, 5" Stem Caster Carts				
18" x 36" x 80"	M1836CG47	70 lbs	M1836CG47-5	80 lbs
18" x 48" x 80"	M1848CG47	78 lbs	M1848CG47-5	92 lbs
18" x 60" x 80"	M1860CG47	99 lbs	M1860CG47-5	116 lbs
24" x 36" x 80"	M2436CG47	82 lbs	M2436CG47-5	95 lbs
24" x 48" x 80"	M2448CG47	96 lbs	M2448CG47-5	112 lbs
24" x 60" x 80"	M2460CG47	118 lbs	M2460CG47-5	139 lbs



M1836SG46

18 GAUGE SOLID GALVANIZED STEEL

DIMENSIONS W" x L" x H"	4 SHELF CARTS		5 SHELF CARTS	
	MODEL NO.	SHIP WGT	MODEL NO.	SHIP WGT
63"H - Post, 5" Stem Caster Carts				
18" x 36" x 69"	M1836SG46	86 lbs	M1836SG46-5	102 lbs
18" x 48" x 69"	M1848SG46	102 lbs	M1848SG46-5	122 lbs
18" x 60" x 69"	M1860SG46	118 lbs	M1860SG46-5	142 lbs
24" x 36" x 69"	M2436SG46	98 lbs	M2436SG46-5	117 lbs
24" x 48" x 69"	M2448SG46	102 lbs	M2448SG46-5	126 lbs
24" x 60" x 69"	M2460SG46	146 lbs	M2460SG46-5	177 lbs
74"H - Post, 5" Stem Caster Carts				
18" x 36" x 80"	M1836SG47	88 lbs	M1836SG47-5	104 lbs
18" x 48" x 80"	M1848SG47	104 lbs	M1848SG47-5	124 lbs
18" x 60" x 80"	M1860SG47	120 lbs	M1860SG47-5	144 lbs
24" x 36" x 80"	M2436SG47	100 lbs	M2436SG47-5	119 lbs
24" x 48" x 80"	M2448SG47	104 lbs	M2448SG47-5	128 lbs
24" x 60" x 80"	M2460SG47	148 lbs	M2460SG47-5	179 lbs

Enclosure Carts

Enclosure carts are an effective way to keep contents from moving or falling off during transportation.

Enclosure carts using rods and tabs are adaptable to any shelf position.

Enclosure dolly base truck using rods and tabs allows for heavier load transport. The rods and tabs act as a perimeter to retain product.

For additional shelves, refer to **pg. 98**.

All units consist of:

- 4 - posts
- 4 or 5 - wire shelves
- 4, 5 or 6 - rods and tabs kits

Mobile unit also includes:

- 4 - 5" swivel thermoplastic resin casters, 2 with brakes
- 4 - donut bumpers

Dolly Base unit also includes:

- 1 - dolly base
- 4 - plate thermoplastic resin casters (2 rigid and 2 swivel with brake)

COMPLETE CARTS INCLUDE CASTER KIT FOR MOBILITY

1,200 lb. MOBILE LOAD CAPACITY

Rods & Tabs

Rods and tabs represent an economical, alternate solution for enclosure on backs and sides of mobile and stationary units.

Each kit includes:

- 3 - rods
- 9 - front/back tabs
- 9 - side/solid shelf tabs.

MODEL NO.	DESCRIPTION	SHIP WGT
Rods & Tabs		
52RT	3 - 52" Rods with Tabs	1 lb
61RT	3 - 61" Rods with Tabs	1 lb
72RT	3 - 72" Rods with Tabs	2 lbs
84RT	3 - 84" Rods with Tabs	2 lbs



M1836C46RE



MD1836C46RE-5



QSRT Side or Solid Shelf Tab



QAT Front or Back Tab

3 SIDED, 4 OR 5 WIRE SHELF CART WITH RODS AND TABS

DIMENSIONS W" x L" x H"	4 SHELF CARTS		5 SHELF CARTS	
	MODEL NO.	SHIP WGT	MODEL NO.	SHIP WGT
63"H - Post, Cart with Rods and Tabs				
18" x 36" x 69"	M1836C46RE	74 lbs	M1836C46RE-5	84 lbs
18" x 48" x 69"	M1848C46RE	84 lbs	M1848C46RE-5	98 lbs
18" x 60" x 69"	M1860C46RE	100 lbs	M1860C46RE-5	117 lbs
24" x 36" x 69"	M2436C46RE	88 lbs	M2436C46RE-5	101 lbs
24" x 48" x 69"	M2448C46RE	104 lbs	M2448C46RE-5	120 lbs
24" x 60" x 69"	M2460C46RE	124 lbs	M2460C46RE-5	145 lbs
74"H - Post, Cart with Rods and Tabs				
18" x 36" x 80"	M1836C47RE	80 lbs	M1836C47RE-5	90 lbs
18" x 48" x 80"	M1848C47RE	92 lbs	M1848C47RE-5	106 lbs
18" x 60" x 80"	M1860C47RE	104 lbs	M1860C47RE-5	121 lbs
24" x 36" x 80"	M2436C47RE	94 lbs	M2436C47RE-5	107 lbs
24" x 48" x 80"	M2448C47RE	112 lbs	M2448C47RE-5	128 lbs
24" x 60" x 80"	M2460C47RE	132 lbs	M2460C47RE-5	153 lbs

CHROME WIRE SHELVES

DOLLY BASE 3 SIDED, 4 OR 5 WIRE SHELF CART WITH RODS AND TABS

DIMENSIONS W" x L" x H"	4 SHELF CARTS		5 SHELF CARTS	
	MODEL NO.	SHIP WGT	MODEL NO.	SHIP WGT
63"H - Post, Dolly Base Carts with Rods and Tabs				
18" x 36" x 70"	MD1836C46RE	86 lbs	MD1836C46RE-5	96 lbs
18" x 48" x 70"	MD1848C46RE	96 lbs	MD1848C46RE-5	110 lbs
18" x 60" x 70"	MD1860C46RE	124 lbs	MD1860C46RE-5	141 lbs
24" x 36" x 70"	MD2436C46RE	113 lbs	MD2436C46RE-5	126 lbs
24" x 48" x 70"	MD2448C46RE	121 lbs	MD2448C46RE-5	137 lbs
24" x 60" x 70"	MD2460C46RE	144 lbs	MD2460C46RE-5	165 lbs
74"H - Post, Dolly Base Carts with Rods and Tabs				
18" x 36" x 81"	MD1836C47RE	92 lbs	MD1836C47RE-5	102 lbs
18" x 48" x 81"	MD1848C47RE	106 lbs	MD1848C47RE-5	120 lbs
18" x 60" x 81"	MD1860C47RE	120 lbs	MD1860C47RE-5	137 lbs
24" x 36" x 81"	MD2436C47RE	108 lbs	MD2436C47RE-5	121 lbs
24" x 48" x 81"	MD2448C47RE	129 lbs	MD2448C47RE-5	145 lbs
24" x 60" x 81"	MD2460C47RE	152 lbs	MD2460C47RE-5	173 lbs

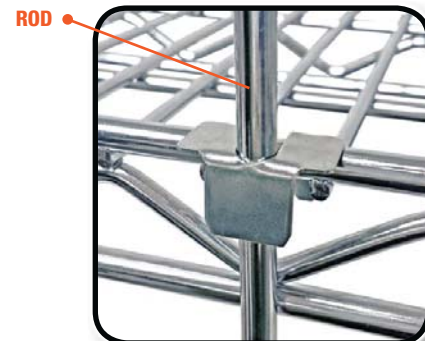



3 SIDED STEM CASTER WIRE SHELF CART WITH 3 OR 4 WIRE SHELVES AND 1 SOLID SHELF WITH RODS AND TABS

DIMENSIONS W" x L" x H"	4 SHELF CARTS		5 SHELF CARTS	
	MODEL NO.	SHIP WGT	MODEL NO.	SHIP WGT
63"H - Post, Cart with Rods and Tabs				
18" x 36" x 69"	M1836CG46RE	83 lbs	M1836CG46RE-5	93 lbs
18" x 48" x 69"	M1848CG46RE	94 lbs	M1848CG46RE-5	108 lbs
18" x 60" x 69"	M1860CG46RE	114 lbs	M1860CG46RE-5	131 lbs
24" x 36" x 69"	M2436CG46RE	96 lbs	M2436CG46RE-5	109 lbs
24" x 48" x 69"	M2448CG46RE	112 lbs	M2448CG46RE-5	128 lbs
24" x 60" x 69"	M2460CG46RE	136 lbs	M2460CG46RE-5	157 lbs
74"H - Post, Cart with Rods and Tabs				
18" x 36" x 80"	M1836CG47RE	89 lbs	M1836CG47RE-5	99 lbs
18" x 48" x 80"	M1848CG47RE	101 lbs	M1848CG47RE-5	115 lbs
18" x 60" x 80"	M1860CG47RE	123 lbs	M1860CG47RE-5	140 lbs
24" x 36" x 80"	M2436CG47RE	102 lbs	M2436CG47RE-5	115 lbs
24" x 48" x 80"	M2448CG47RE	119 lbs	M2448CG47RE-5	135 lbs
24" x 60" x 80"	M2460CG47RE	144 lbs	M2460CG47RE-5	166 lbs

CHROME WIRE AND 18 GAUGE SOLID GALVANIZED STEEL SHELVES

DOLLY BASE 3 SIDED WIRE SHELF CART WITH 3 OR 4 WIRE SHELVES AND 1 SOLID SHELF WITH RODS AND TABS

DIMENSIONS W" x L" x H"	4 SHELF CARTS		5 SHELF CARTS	
	MODEL NO.	SHIP WGT	MODEL NO.	SHIP WGT
63"H - Post, Dolly Base Carts with Rods and Tabs				
18" x 36" x 70"	MD1836CG46RE	93 lbs	MD1836CG46RE-5	102 lbs
18" x 48" x 70"	MD1848CG46RE	106 lbs	MD1848CG46RE-5	116 lbs
18" x 60" x 70"	MD1860CG46RE	128 lbs	MD1860CG46RE-5	147 lbs
24" x 36" x 70"	MD2436CG46RE	109 lbs	MD2436CG46RE-5	132 lbs
24" x 48" x 70"	MD2448CG46RE	127 lbs	MD2448CG46RE-5	145 lbs
24" x 60" x 70"	MD2460CG46RE	154 lbs	MD2460CG46RE-5	175 lbs
74"H - Post, Dolly Base Carts with Rods and Tabs				
18" x 36" x 81"	MD1836CG47RE	99 lbs	MD1836CG47RE-5	108 lbs
18" x 48" x 81"	MD1848CG47RE	113 lbs	MD1848CG47RE-5	126 lbs
18" x 60" x 81"	MD1860CG47RE	137 lbs	MD1860CG47RE-5	143 lbs
24" x 36" x 81"	MD2436CG47RE	115 lbs	MD2436CG47RE-5	127 lbs
24" x 48" x 81"	MD2448CG47RE	134 lbs	MD2448CG47RE-5	153 lbs
24" x 60" x 81"	MD2460CG47RE	163 lbs	MD2460CG47RE-5	183 lbs



M1836CG46RE



MD1836CG46RE-5

Enclosure Carts

Enclosure carts are an effective way to keep contents from moving or falling off during transportation.

Enclosure carts using rods and tabs are adaptable to any shelf position.

Enclosure dolly base truck using rods and tabs allows for heavier load transport. The rods and tabs act as a perimeter to retain product.

For additional shelves, refer to [pg. 98](#).

All units consist of:

- 4 - posts
- 3 or 4 - wire shelves
- 1 - solid shelf
- 4, 5 or 6 - rods and tabs kits

Mobile unit also includes:

- 4 - 5" swivel thermoplastic resin casters, 2 with brakes
- 4 - donut bumpers

Dolly Base unit also includes:

- 1 - dolly base
- 4 - plate thermoplastic resin casters (2 rigid and 2 swivel with brake)

COMPLETE CARTS INCLUDE CASTER KIT FOR MOBILITY

1,200 lb. MOBILE LOAD CAPACITY

NYLON FABRIC OR CLEAR VINYL CART COVERS AVAILABLE

See [pg. 136](#)



WHITE NYLON

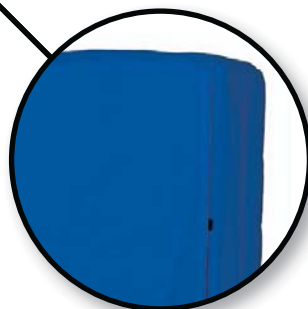

BLUE NYLON



CLEAR VINYL

CART COVERS

Protect against pilferage, airborne dust, moisture, and other contaminants

Enclosure Carts

Finish: Chrome

Each unit consists of:

- 4 - posts
- 4 or 5 - wire shelves
- 4 - enclosure panels
- 4 - 5" swivel thermoplastic resin casters, 2 with brakes
- 4 - donut bumpers

NYLON FABRIC OR CLEAR VINYL CART COVERS AVAILABLE

See pg. 136



BLUE NYLON CART COVER

Protect against pilferage, airborne dust, moisture and other contaminants

All units consist of:

- 4 - posts
- 3 or 4 - wire shelves
- 1 - solid shelf
- 4 or 5 - enclosure panels

Mobile unit also includes:

- 4 - 5" swivel thermoplastic resin casters, 2 with brakes
- 4 - donut bumpers

Dolly Base unit also includes:

- 1 - dolly base
- 4 - plate thermoplastic resin casters (2 rigid and 2 swivel with brake)



M2436C46E



WRCS4-63-2460EP-5



WRDBS4-63-2460EP

CHROME WIRE SHELVES

3 SIDED, 4 OR 5 WIRE SHELF CART WITH ENCLOSURE PANELS

DIMENSIONS W" x L" x H"	4 SHELF CARTS		5 SHELF CARTS	
	MODEL NO.	SHIP WGT	MODEL NO.	SHIP WGT
63"H - Post, Cart with Enclosure Panels				
24" x 36" x 69"	M2436C46E	145 lbs	M2436C46E-5	158 lbs
24" x 48" x 69"	M2448C46E	179 lbs	M2448C46E-5	195 lbs
24" x 60" x 69"	M2460C46E	197 lbs	M2460C46E-5	218 lbs

COMPLETE CARTS INCLUDE CASTER KIT FOR MOBILITY

1,200 lb. MOBILE LOAD CAPACITY

3 SIDED STEM CASTER ENCLOSURE CART WITH 3 OR 4 WIRE SHELVES AND 1 SOLID SHELF WITH ENCLOSURE PANELS

DIMENSIONS W" x L" x H"	4 SHELF CARTS		5 SHELF CARTS	
	MODEL NO.	SHIP WGT	MODEL NO.	SHIP WGT
63"H - Post, Cart with Solid Bottom Shelf and Enclosure Panels				
24" x 36" x 69"	WRCS4-63-2436EP	113 lbs	WRCS4-63-2436EP-5	126 lbs
24" x 48" x 69"	WRCS4-63-2448EP	131 lbs	WRCS4-63-2448EP-5	147 lbs
24" x 60" x 69"	WRCS4-63-2460EP	158 lbs	WRCS4-63-2460EP-5	179 lbs
74"H - Post, Cart with Solid Bottom Shelf and Enclosure Panels				
24" x 36" x 80"	WRCS4-74-2436EP	113 lbs	WRCS4-74-2436EP-5	126 lbs
24" x 48" x 80"	WRCS4-74-2448EP	131 lbs	WRCS4-74-2448EP-5	147 lbs
24" x 60" x 80"	WRCS4-74-2460EP	158 lbs	WRCS4-74-2460EP-5	179 lbs

CHROME WIRE AND 18 GAUGE SOLID GALVANIZED STEEL SHELVES

3 SIDED DOLLY BASE ENCLOSURE CART WITH 3 OR 4 WIRE SHELVES AND 1 SOLID SHELF WITH ENCLOSURE PANELS

DIMENSIONS W" x L" x H"	4 SHELF CARTS		5 SHELF CARTS	
	MODEL NO.	SHIP WGT	MODEL NO.	SHIP WGT
63"H - Post, Dolly Base Cart with Solid Bottom Shelf and Enclosure Panels				
24" x 36" x 70"	WRDBS4-63-2436EP	124 lbs	WRDBS4-63-2436EP-5	137 lbs
24" x 48" x 70"	WRDBS4-63-2448EP	142 lbs	WRDBS4-63-2448EP-5	158 lbs
24" x 60" x 70"	WRDBS4-63-2460EP	169 lbs	WRDBS4-63-2460EP-5	190 lbs
74"H - Post, Dolly Base Cart with Solid Bottom Shelf and Enclosure Panels				
24" x 36" x 81"	WRDBS4-74-2436EP	124 lbs	WRDBS4-74-2436EP-5	137 lbs
24" x 48" x 81"	WRDBS4-74-2448EP	142 lbs	WRDBS4-74-2448EP-5	158 lbs
24" x 60" x 81"	WRDBS4-74-2460EP	169 lbs	WRDBS4-74-2460EP-5	190 lbs



Security Units

Stationary and Mobile Units prevent pilferage while allowing high visibility of contents at all times. All side and back panels are heavy gauge wire construction and are manufactured of all-welded heavy-duty 1/4" diameter wire on 2" x 2" centers. Assembly is quick and easy. **Finish:** Chrome and Proform Green Epoxy

WANT TO SECURE YOUR EXISTING SHELVING UNITS?



Thick wire gauge ensures strong and dependable security yet easy visibility



2436-63SEC

Security Panel Doors

Each door set has left and right panel with 4 hinge bars. Assembly is quick and easy and adapts to the appropriate shelf size, with standard post of 63" high.

CHROME	GREEN EPOXY	NEW FINISH	
MODEL NO.	MODEL NO. (NEW)	DIMENSIONS L" x H"	SHIP WGT
Security Panel Door Set with Hinges			
SD36C	SD36P	36" x 60"	54 lbs
SD48C	SD48P	48" x 60"	66 lbs
SD60C	SD60P	60" x 60"	78 lbs



DOOR TOP SECURITY
Channel reinforced door frame with heavy-duty top hinge pin



DOOR MIDDLE SECURITY
Channel reinforced door frame with middle clasp for lock (*Sold separately*)



DOOR BOTTOM SECURITY
Channel reinforced door frame with heavy-duty bottom hinge pin



M2436-69SEC



MD2436-70SEC

NYLON FABRIC OR CLEAR VINYL UNIT COVERS AVAILABLE FOR ALL SECURITY UNITS See pg. 140

1,200 lb.
MOBILE LOAD CAPACITY

Stationary Security Units

Intermediate shelves can be purchased separately, see [pg. 98](#). **Finish:** Chrome and Proform Green Epoxy

Each unit consists of:

- 4 - posts
- 2 - wire shelves (*for top and bottom*)
- 1 - security panel set (*includes back and sides*)
- 1 - pair security panel doors

MODEL NO.	DIMENSIONS W" x L" x H"	SHIP WGT
Stationary Security Units		
2436-63SEC	24" x 36" x 63"	165 lbs
2448-63SEC	24" x 48" x 63"	192 lbs
2460-63SEC	24" x 60" x 63"	224 lbs

ADD SUFFIX "P" TO MODEL NO. TO ORDER GREEN EPOXY FINISH

Ex. 2436-63SECP

Stem Caster Security Carts

Mobility adds flexibility to a unit and is beneficial in all types of operations. Intermediate shelves can be purchased separately, see [pg. 98](#). **Finish:** Chrome and Proform Green Epoxy

Each unit consists of:

- 4 - posts
- 2 - wire shelves (*for top and bottom*)
- 1 - security panel set (*includes back and sides*)
- 1 - pair security panel doors
- 4 - 5" thermoplastic resin casters, 2 with brake
- 4 - donut bumpers

MODEL NO.	DIMENSIONS W" x L" x H"	SHIP WGT
Stem Caster Security Carts		
M2436-69SEC	24" x 36" x 69"	173 lbs
M2448-69SEC	24" x 48" x 69"	200 lbs
M2460-69SEC	24" x 60" x 69"	232 lbs

Dolly Base Security Carts

Dollies can add stability and support in heavy-duty load applications. Intermediate shelves can be purchased separately, see [pg. 98](#). **Finish:** Chrome and Proform Green Epoxy

Each unit consists of:

- 4 - posts
- 2 - wire shelves (*for top and bottom*)
- 1 - security panel set (*includes back and sides*)
- 1 - pair security panel doors
- 1 - dolly base
- 4 - plate thermoplastic resin casters (*2 rigid and 2 swivel with brake*)

MODEL NO.	DIMENSIONS W" x L" x H"	SHIP WGT
Dolly Base Security Carts		
MD2436-70SEC	24" x 36" x 70"	186 lbs
MD2448-70SEC	24" x 48" x 70"	215 lbs
MD2460-70SEC	24" x 60" x 70"	250 lbs

High Density Sliding Floor Track System



High Density Sliding Track System offers a unique way to maximize and efficiently move wire shelving systems. The patented design allows for quick and easy installation. Bearings in the skate are located under each post for a load capacity of 1,500 lb. per shelving unit. The v-groove floor track allows the shelving unit to slide back and forth with ease. Layout assistance is available.

PERFORMANCE FEATURES AND BENEFITS

- Low shipping cost
- NSF approved
- Uses industrial bearings
- Corrosion free construction
- Easy to roll construction
- Fast installation
- Utilizes the structure of existing shelving
- Complies with ADA regulations
- 1,500 lb. load capacity per unit
- Can increase storage areas up to 150%



SYSTEMS SLIDE BACK AND FORTH WITH EASE

QESTP

End Stop Kit

Includes 2 ends and 1 drill bit. Serves the dual purpose of stopping a skate and is the anchor for the track. Manufactured from shock absorbing polymer. One kit is required per track.

QVTRK

V-Groove Track

Aluminum design with 304 stainless steel inserts with a gradual taper, non-tripping hazard, 7/16" max height. (Sold by the inch)

HD18 - HD36
One Skate

Aluminum with engineered plastic wheel housing and industrial 2,000 lb. bearings on each end.

WK
Wing Kit

Includes four 1/4" thick aluminum plates and hardware and allows for the joining of 2 units side by side, sharing one track.

SK
Shim Kit

48"L thick aluminum strips which can be placed underneath track to help create a level surface. (6 per kit)

MODEL NO.	DESCRIPTION	SHIP WGT
Stationary Security Units		
HD18	One 18" Skate	4 lbs
HD21	One 21" Skate	5 lbs
HD24	One 24" Skate	6 lbs
HD30	One 30" Skate	7 lbs
HD36	One 36" Skate	8 lbs
Additional Components		
QESTP	End Stop Kit	1 lb
QVTRK	V-Track (Sold per inch)	1 lb
WK	Wing Kit	2 lbs
SK*	Shim Kit	3 lbs

*Shim kit comes with (6) 2" x 48" x 1/16" thick aluminum strips which can be placed underneath track to help create a level surface

STEP BY STEP ORDERING INSTRUCTIONS:

- (Note: Shelves and posts to be purchased separately on pgs. 98-99)
- Step 1.** Select desired length (in inches) of track. Use QVTRK to order track. (Note: single units require two tracks and double units will require three tracks)
- Step 2.** Select corresponding skate size from the chart, which will be the same as the depth of shelving unit to be utilized. Two skates required per single unit and three skates required per double unit. (Note: post height should not exceed a 4 to 1 ratio of skate size)
- Step 3.** Purchase one End Stop Kit QESTP per track length. For each double unit being used, a Wing Kit WK is required.



SINGLE UNIT TRACK SYSTEM

(Top View)

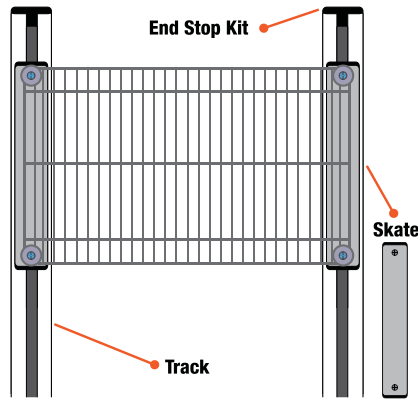

DOUBLE UNIT TRACK SYSTEM

(Top View)

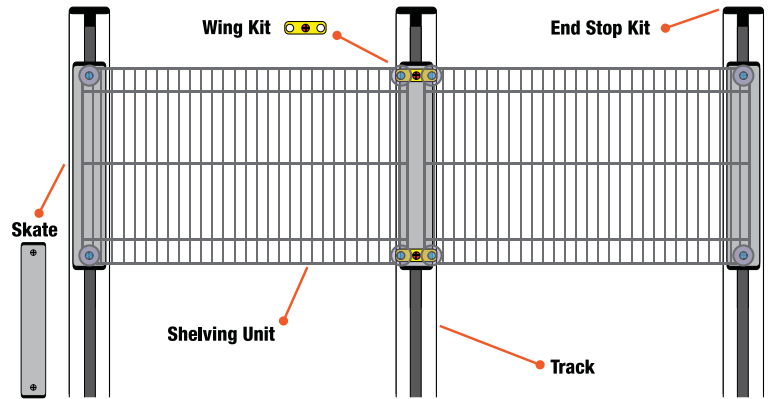

Single Unit Floor Track Assemblies



Assembly kit consists of a pair of aluminum tracks with end stop kits. Hardware and assembly instructions included. (Note: custom lengths may be purchased, see pg. 142)

Table with 4 columns: MODEL NO., TRACK L' (FT), TRACK L' (IN), SHIP WGT. Lists various single unit floor track assembly kits.

1,500 lb. SLIDE LOAD CAPACITY PER SHELVING UNIT

STEP BY STEP ORDERING INSTRUCTIONS:

- 1. Select desired length of track and if you require:
- Single Unit track (use charts on left)
- Double Unit track (use charts on right)
2. Select corresponding skate size from single or double unit charts below. Skate size should match the depth of shelving unit being utilized.
3. Using the chart on the bottom of this page, determine how many shelving units will fit on your track.
4. Pre-configured 4 and 5 shelf wire units are available on pgs. 100-103. Additional intermediate shelves are available on pg. 98.

Double Unit Floor Track Assemblies



Each assembly kit consists of three aluminum tracks with end stop kits. Hardware and assembly instructions included. (Note: custom lengths may be purchased, see pg. 142)

Table with 4 columns: MODEL NO., TRACK L' (FT), TRACK L' (IN), SHIP WGT. Lists various double unit floor track assembly kits.

Single Unit Skate Assembly Kits



Each kit includes two skates and all appropriate hardware. One kit is required for each single mobile unit. (Shelves and posts sold separately on pgs. 98 & 99)

Table with 3 columns: MODEL NO., DESCRIPTION, SHIP WGT. Lists single unit skate assembly kits.

Double Unit Skate Assembly Kits



Each kit includes three skates and all appropriate hardware. One kit is required for each double mobile unit. (Shelves and posts sold separately on pgs. 98 & 99)

Table with 3 columns: MODEL NO., DESCRIPTION, SHIP WGT. Lists double unit skate assembly kits.

QUANTITY OF SHELVING UNITS BY WIDTH TO FIT ON LENGTH OF TRACK*

Chart showing the quantity of shelving units that can fit on tracks of various lengths (6' to 20') for different skate widths (18", 21", 24", 30", 36").

*Using a minimum 36" aisle space Note: Post height should not exceed the skate length by a 4 to 1 ration (example 18" skate should not exceed a 74" post)

UNITS SLIDE BACK AND FORTH WITH EASE

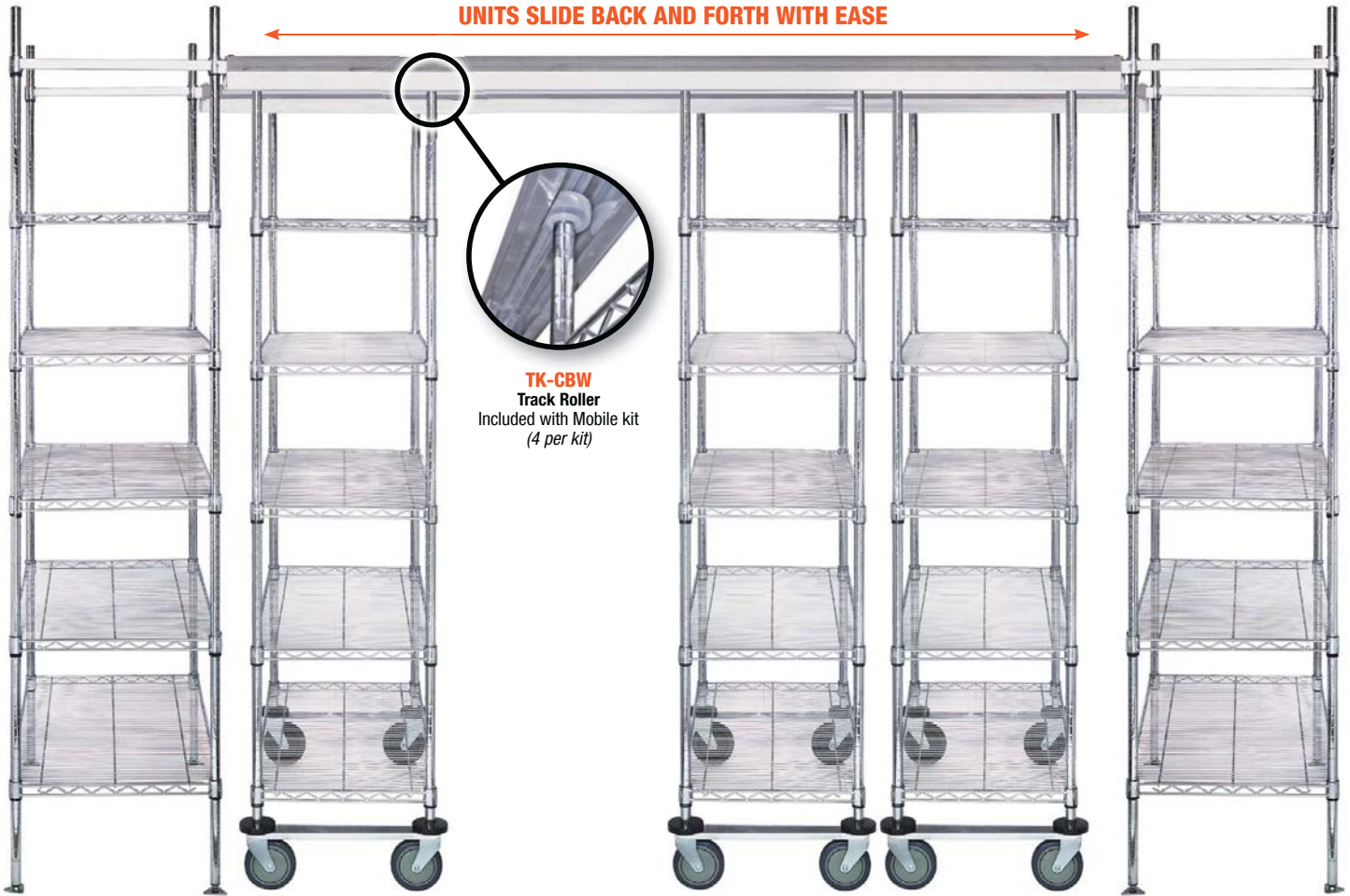

TK-CBW
Track Roller
 Included with Mobile kit
 (4 per kit)

Sliding Overhead Track System



Quantum's Overhead Track wire shelving system provides maximum storage using a minimum of space. All kits include all necessary sections of track for assembling lengths that range from 8' to 24' (*note: shelves and posts sold separately*). Assembly is quick and easy and the whole system requires only single-aisle access. Casters are 5" x 1-1/4" rigid thermoplastic resin. Overhead Track design provides a clear walkway and clear aisles underneath eliminating any tripping hazard. Overhead Track extrusion manufactured of heavy-duty aluminum ensuring years of heavy-duty and reliable service.

MODEL NO.	DESCRIPTION	SHIP WGT
Overhead Track		
TK-2	One Track - 2 Feet	7 lbs
TK-26	One Track - 2-1/2 Feet	9 lbs
TK-5	One Track - 5 Feet	17 lbs
TK-6	One Track - 6 Feet	21 lbs
TK-7	One Track - 7 Feet	24 lbs
TK-EP	Track End Plates with Hardware (Set of 4)	1 lb
TK-CA	Track Connector with Hardware (Set of 4)	6 lbs
End Unit Single Sided Track Bracket Pair		
TK-STB18	18" Single Overhead Track Bracket Pair	4 lbs
TK-STB21	21" Single Overhead Track Bracket Pair	5 lbs
TK-STB24	24" Single Overhead Track Bracket Pair	6 lbs
Intermediate Unit Double Sided Track Bracket Pair		
TK-DTB18	18" Double Overhead Track Bracket Pair	4 lbs
TK-DTB21	21" Double Overhead Track Bracket Pair	5 lbs
TK-DTB24	24" Double Overhead Track Bracket Pair	6 lbs
Mobile Unit Track Rollers		
TK-CBW	Set of 4 Track Rollers	2 lbs

PERFORMANCE FEATURES AND BENEFITS

- NSF approved
- Uses industrial bearings
- Corrosion free construction
- Easy to roll construction
- Fast installation
- Utilizes the structure of existing shelving
- 1,200 lb. load capacity per unit
- Can increase storage areas up to 150%



TK-EP
Track End Plate
 (4 per kit)



TRACK WITHOUT END PLATE



TRACK WITH END PLATE



INCREASE STORAGE AREAS UP TO 150%

SLIDING OVERHEAD TRACK SYSTEM



STATIONARY END KIT
(Shelves sold separately)



INTERMEDIATE KIT
(Shelves sold separately)



MOBILE KIT
(Shelves sold separately)

STEP BY STEP ORDERING INSTRUCTIONS:

- Step 1.** Select desired length of track.
- Step 2.** Select corresponding stationary end kit and intermediate kits from charts. Size should match the depth of shelving unit being utilized.
- Step 3.** Using the chart on the bottom of this page, determine how many Mobile Kits will fit on your track.
- Step 4.** Wire shelves are available on [pg. 98](#).



OVERHEAD TRACK KIT WITH END PLATES

Overhead Track Kits

Each kit includes two track of the same length and end plates.

MODEL NO.	TRACK L' (FT)	TRACK L' (IN)	SHIP WGT
Overhead Track Kit			
TTK-8	8'	96"	53 lbs
TTK-9	9'	108"	60 lbs
TTK-10	10'	120"	67 lbs
TTK-11	11'	132"	73 lbs
TTK-12	12'	144"	80 lbs
TTK-13	13'	156"	87 lbs
TTK-14	14'	168"	93 lbs
TTK-15	15'	180"	100 lbs
TTK-16	16'	192"	107 lbs
TTK-17	17'	204"	113 lbs
TTK-18	18'	216"	120 lbs
TTK-19	19'	228"	127 lbs
TTK-20	20'	240"	133 lbs
TTK-21	21'	252"	140 lbs

Stationary End Kits



SINGLE SUPPORT BRACKET

- Unit consists of:
- 8 - 86" Posts
 - 8 - Foot plates
 - 4 - Single sided overhead track support brackets

MODEL NO.	DESCRIPTION	SHIP WGT
TTK-E18	18" Stationary End Kits	64 lbs
TTK-E21	21" Stationary End Kits	72 lbs
TTK-E24	24" Stationary End Kits	80 lbs

Intermediate Kits



DOUBLE SUPPORT BRACKET

- Unit consists of:
- 4 - 86" Posts
 - 4 - Foot plates
 - 2 - Double sided overhead track support brackets

MODEL NO.	DESCRIPTION	SHIP WGT
TTK-C18	18" Intermediate Kits	32 lbs
TTK-C21	21" Intermediate Kits	36 lbs
TTK-C24	24" Intermediate Kits	40 lbs

Mobile Kits



MOBILE KITS

- Unit consists of:
- 4 - 74" Posts
 - 4 - Track rollers
 - 2 - Tie bars
 - 4 - Rigid casters
 - 4 - Donut bumpers

MODEL NO.	DESCRIPTION	SHIP WGT
TTK-M18	18" Mobile Kit	34 lbs
TTK-M21	21" Mobile Kit	36 lbs
TTK-M24	24" Mobile Kit	38 lbs

QUANTITY OF SHELVING UNITS BY WIDTH TO FIT ON LENGTH OF TRACK*

	8'	9'	10'	11'	12'	13'	14'	15'	16'	17'	18'	19'	20'	21'
18"	3	3	4	4	5	6	6	7	7	8	9	9	10	10
21"	2	3	3	4	4	5	5	6	6	7	7	8	8	9
24"	2	2	3	3	4	4	5	5	6	6	6	7	7	8

*Using a minimum 36" aisle space



Modular Enclosure Panels

NEW FINISH

Are easily adaptable to standard shelving units to create a secured storage area.

- Panels are fabricated from 6 gauge wire on 3" x 3" squares
- Modular enclosure panels work with four shelf depths: 14", 18", 21" and 24" and three heights: 63", 74" and 86"
- One modular enclosure panel is needed for each side and two or three panels are needed for the back
- New **EP-CLIP** hardware package allows enclosure panels to be fastened tight to the shelves to help eliminate any rattling noise while in transit. One package needed per enclosure panel.

CHROME	STAINLESS STEEL	PROFORM GREEN EPOXY <small>NEW</small>		
MODEL NO.	MODEL NO.	MODEL NO.	DESCRIPTION	SHIP WGT
EP126	EP126S	EP126P	One 12" x 62" Panel	5 lbs
EP166	EP166S	EP166P	One 16" x 62" Panel	6 lbs
EP196	EP196S	EP196P	One 19" x 62" Panel	7 lbs
EP226	EP226S	EP226P	One 22" x 62" Panel	8 lbs
EP127	EP127S	EP127P	One 12" x 73" Panel	6 lbs
EP167	EP167S	EP167P	One 16" x 73" Panel	7 lbs
EP197	EP197S	EP197P	One 19" x 73" Panel	8 lbs
EP227	EP227S	EP227P	One 22" x 73" Panel	9 lbs
EP128	EP128S	EP128P	One 12" x 84" Panel	7 lbs
EP168	EP168S	EP168P	One 16" x 84" Panel	8 lbs
EP198	EP198S	EP198P	One 19" x 84" Panel	9 lbs
EP228	EP228S	EP228P	One 22" x 84" Panel	10 lbs



MOBILE CART SHOWN WITH 4 ENCLOSURE PANELS. MOBILE ENCLOSURE CARTS AVAILABLE

See pgs. 138-140



HB18C

Hang Rails

CHROME	STAINLESS STEEL		
MODEL NO.	MODEL NO.	DESCRIPTION	SHIP WGT
HB18C	HB18S	One 18" Hang Rail	3 lbs
HB24C	HB24S	One 24" Hang Rail	4 lbs
HB36C	HB36S	One 36" Hang Rail	5 lbs
HB48C	HB48S	One 48" Hang Rail	6 lbs
HB60C	HB60S	One 60" Hang Rail	7 lbs



Collar Hooks

Used to secure baskets to posts or as a hook for longer items. Sold in packs of four.

MODEL NO.	DESCRIPTION	SHIP WGT
SCH1-5	1-1/2" Hook (4 Packs)	1 lb
SCH1	1/2" Hook (4 Packs)	1 lb



DB1836S

Modular Dolly Frames

Dolly Frames allow standard shelving units to be converted to heavy-duty transport trucks. Frames are fabricated from heavy gauge steel. Bumpers are attached to each corner to protect walls and help cushion impact. **Finishes:** Chrome and Stainless Steel (Plate casters sold separately)

CHROME	STAINLESS STEEL		
MODEL NO.	MODEL NO.	DIMENSIONS W" x L"	SHIP WGT
DB1836C	DB1836S	18" x 36"	10 lbs
DB1848C	DB1848S	18" x 48"	12 lbs
DB1860C	DB1860S	18" x 60"	14 lbs
DB2436C	DB2436S	24" x 36"	13 lbs
DB2448C	DB2448S	24" x 48"	15 lbs
DB2460C	DB2460S	24" x 60"	18 lbs



DS18-24

CHOOSE FROM ONE BIN/TRAY DESIGN OR TWO BIN/TRAY DESIGN

Single and Double Drawer Slides

Compliment any system with specialized areas for storage which allow bins and trays to be suspended between shelves. Single bin slide mounts 18", 21" and 24" shelves. Double bin slide adapts to 24" shelves only. (Bins sold separately) **Finish:** Chrome

MODEL NO.	DESCRIPTION	SHIP WGT
DS18-24	Single Bin Design	2 lbs
DDS-24	Double Bin Design	4 lbs



WCSD-1820

Wire Carton Dividers

NEW

Quantum's new wire carton dividers are the ideal storage tool to maintain and organize your boxes. Available for 18" and 24" shelf depths, the dividers fix in place and provide firm and convenient storage to your warehouse and workplace. Two convenient heights to choose from: 14" or 20-1/2". **Finish:** Chrome

MODEL NO.	DESCRIPTION	SHIP WGT
WCSD-1814	18" x 14" Divider	1 lb
WCSD-1820	18" x 20-1/2" Divider	1 lb
WCSD-2414	24" x 14" Divider	1 lb
WCSD-2420	24" x 20-1/2" Divider	1 lb



Push Handles

Comfortable grip design. Five widths available enabling easy movement of any mobile unit. To order a Proform Green, Gray or Black Epoxy finish, add **P**, **GY** or **BK** right after chrome model no. prefix (i.e. PH18**P**, PH18**GY** or PH18**BK**). **Finishes:** Chrome, Stainless Steel, Proform Green, Gray and Black Epoxy



CHROME	STAINLESS STEEL	AVAILABLE EPOXY			DESCRIPTION	SHIP WGT
MODEL NO.	MODEL NO.	NEW P	NEW GY	BK		
PH18	PH18S	Y	Y	Y	One 18" Push Handle	2 lbs
PH21	PH21S	Y	Y	N	One 21" Push Handle	3 lbs
PH24	PH24S	Y	Y	Y	One 24" Push Handle	3 lbs
PH30	-	N	N	N	One 30" Push Handle	3 lbs
PH36	PH36S	N	N	N	One 36" Push Handle	3 lbs

U-Handles

Build your own special size utility cart with three different width choices: 18", 21" or 24". Overall height 32", not including casters. To order a Proform Green, Gray or Black Epoxy finish, add **P**, **GY** or **BK** right after chrome model no. prefix (i.e. UH18**P**, UH18**GY** or UH18**BK**). **Finishes:** Chrome, Stainless Steel, Proform Green, Gray and Black Epoxy



CHROME	STAINLESS STEEL	AVAILABLE EPOXY			DESCRIPTION	SHIP WGT
MODEL NO.	MODEL NO.	NEW P	NEW GY	BK		
UH18	UH18S	Y	Y	Y	18" U-Handle	2 lbs
UH21	UH21S	Y	Y	N	21" U-Handle	3 lbs
UH24	UH24S	Y	Y	Y	24" U-Handle	3 lbs

Shelf Inlay Mats

An economical solution to convert a wire shelf to a solid surface preventing items from falling through. White shelf inlay mat is easily removable for cleaning. Manufactured of polyethylene, .5 mm thickness.

MODEL NO.	DESCRIPTION	SHIP WGT
1836SM	One 18" x 36" Inlay Mat	1 lb
1848SM	One 18" x 48" Inlay Mat	2 lbs
1860SM	One 18" x 60" Inlay Mat	2 lbs
1872SM	One 18" x 72" Inlay Mat	2 lbs
2436SM	One 24" x 36" Inlay Mat	2 lbs
2448SM	One 24" x 48" Inlay Mat	2 lbs
2460SM	One 24" x 60" Inlay Mat	2 lbs
2472SM	One 24" x 72" Inlay Mat	3 lbs



Tie Bars

Required with rigid casters to ensure rigid alignment. Tie bar length should match up to shelf depth. Rigid casters sold separately. **Finish:** Chrome

MODEL NO.	DESCRIPTION	SHIP WGT
18TB	One 18" Tie Bar which Fits 2 Casters	2 lbs
21TB	One 21" Tie Bar which Fits 2 Casters	2 lbs
24TB	One 24" Tie Bar which Fits 2 Casters	2 lbs
30TB	One 30" Tie Bar which Fits 2 Casters	2 lbs
36TB	One 36" Tie Bar which Fits 2 Casters	3 lbs



Side and Back Ledges

Ledges are 4"H and act as a perimeter to retain shelf items and prevent anything from falling off. To order a Proform Green, Gray or Black Epoxy finish, add **P**, **GY** or **BK** right after chrome model no. prefix (i.e. SL12**P**, SL12**GY** or SL12**BK**). **Finishes:** Chrome, Stainless Steel, Proform Green, Gray and Black Epoxy

CHROME	STAINLESS STEEL	AVAILABLE EPOXY			DESCRIPTION	SHIP WGT
MODEL NO.	MODEL NO.	NEW P	NEW GY	BK		
4"H - Side Ledges						
SL12	SL12S	Y	Y	Y	12" Side Ledge	1 lb
SL14	SL14S	Y	Y	Y	14" Side Ledge	1 lb
SL18	SL18S	Y	Y	Y	18" Side Ledge	1 lb
SL21	SL21S	Y	Y	Y	21" Side Ledge	2 lbs
SL24	SL24S	Y	Y	Y	24" Side Ledge	2 lbs
SL30	SL30S	Y	Y	Y	30" Side/Back Ledge	2 lbs
4"H - Back Ledges						
BL36	BL36S	Y	Y	Y	36" Back/Side Ledge	3 lbs
BL42	BL42S	Y	Y	Y	42" Back Ledge	3 lbs
BL48	BL48S	Y	Y	Y	48" Back Ledge	3 lbs
BL54	BL54S	Y	Y	Y	54" Back Ledge	4 lbs
BL60	BL60S	Y	Y	Y	60" Back Ledge	5 lbs
BL72	BL72S	Y	Y	Y	72" Back Ledge	6 lbs

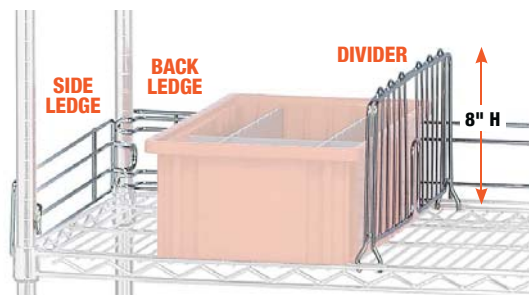

Dividers

Dividers are 8"H and are available in 7 depths to be used with all shelves. To order a Proform Green, Gray or Black Epoxy finish, add **P**, **GY** or **BK** right after chrome model no. prefix (i.e. DIV12**P**, DIV12**GY** or DIV12**BK**). **Finishes:** Chrome, Stainless Steel, Proform Green, Gray and Black Epoxy

CHROME	STAINLESS STEEL	AVAILABLE EPOXY			DESCRIPTION	SHIP WGT
MODEL NO.	MODEL NO.	NEW P	NEW GY	BK		
Dividers						
DIV12	DIV12S	Y	Y	Y	One 12" Divider	2 lbs
DIV14	DIV14S	Y	Y	Y	One 14" Divider	2 lbs
DIV18	DIV18S	Y	Y	Y	One 18" Divider	2 lbs
DIV21	DIV21S	Y	Y	Y	One 21" Divider	3 lbs
DIV24	DIV24S	Y	Y	Y	One 24" Divider	3 lbs
DIV30	DIV30S	Y	Y	Y	One 30" Divider	4 lbs
DIV36	DIV36S	Y	Y	Y	One 36" Divider	4 lbs

Post Clamps

Joins multiple units of shelving. **Finish:** Chrome

MODEL NO.	DESCRIPTION	SHIP WGT
PCL1	1/2" Post Clamp	4 lbs
PCL2	3-1/3" Post Clamp	5 lbs



Hang Bars

- Holds 75 lb. weight capacity evenly distributed

Finish: Chrome

MODEL NO.	DESCRIPTION	SHIP WGT
Intermediate		
GR24	One 24" Hang Bar	2 lbs
Full Length		
GR36	One 36" Hang Bar	3 lbs
GR48	One 48" Hang Bar	4 lbs
GR60	One 60" Hang Bar	5 lbs



GR24



GR36, GR48, GR60

Conductive Accessories



ESD-SS
Aluminum Split Sleeve
Aluminum Split Sleeves required when grounding standard wire shelving in conductive applications. Sold as a pack of 4 pairs.



WR-SSCO
Plastic Conductive Split Sleeve
Sold as a pack of 4 pairs.



ESD-DC
Drag Chain
Drag chain is mounted to bottom of shelf and is used to ground standard wire shelving units. Recommended to be used in conjunction with aluminum or plastic conductive split sleeves and conductive casters.



S-Hooks

NEW FINISH

For continuous runs of shelving. Two hooks should be used per shelf where two posts are not utilized. Sold as an 8 pack. **Finishes:** Chrome, Stainless Steel, Proform Green, Gray and Black Epoxy



- S-HOOK**
Chrome
- S-HOOKSS**
Stainless Steel
- S-HOOKP**
Proform Green Epoxy
- NEW**
S-HOOKGY
Gray Epoxy
- S-HOOKBK**
Black Epoxy



UB10
Utility Basket
An additional storage or display area outside the perimeter of the shelf. Measures 18-7/8"W x 11-1/4"D x 7-5/8"H
Finish: Chrome



DH8
Document Holder
Provides an effective way to secure documents or folders. Measures 12-3/8"W x 2"D x 8-5/8"H
Finish: Chrome

Seismic Foot Plates

NEW

Quantum's seismic foot plates are used to anchor stationary shelving units to the floor.

MODEL NO.	DESCRIPTION	SHIP WGT
WR-SFP NEW	Single Seismic Foot Plate	3 lbs
WR-DFP NEW	Double Seismic Foot Plate	4 lbs



OSHPD
Certification

Single and Double Foot Plates
Shown with Posts and 2 Cotter Pins per plate upright



KEYBD
Keyboard Shelf
Mounts under any size wire shelf and accepts keyboards up to 21"W x 11"D. Has a 6" height adjustment. Measures 25-1/4"W x 15"D x 4-1/4"H
Finish: Chrome



WR-WMB
Post Wall Mount Bracket
Mounts post to wall securely. 2" clearance required.
Finish: Chrome



FG
Non-Marring Floor Glides
Affixes to bottom of bolt. Serves as protection to prevent marring of floors. Sold as a 4 pack.



WR-SS
Split Sleeve
Sold as a pack of 4 pairs.



WR-SP
Shelf Collar Plug
Sold as a pack of 4 pieces.
Finish: Chrome



FP
Foot Plate
Triangular plate allows additional surface to disperse weight.
Finish: Chrome



ADD YOUR CASTER KIT TO YOUR UNIT FOR MOBILITY

1,200-3,200 lb. MOBILE LOAD CAPACITY

Donut Bumper



Non-marking, 3" diameter plastic bumper used to protect walls and help cushion impact.

MODEL NO.	DESCRIPTION	SHIP WGT
DB	One 3" Diameter Donut Bumper	1 lb

Casters

MODEL NO.	DESCRIPTION	LOAD CAPACITY PER CASTER	SHIP WGT
Stem Casters			
WR-00H	Four Swivel 5" x 1-1/4" Thermoplastic Resin Casters, 2 with brake	300 lbs	10 lbs
WR-00HS	Four Swivel 5" x 1-1/4" Thermoplastic Resin Stainless Steel Casters with Zerk Grease Fittings, 2 with brake	300 lbs	12 lbs
WR-00CO	Four Swivel ESD/Conductive 5" x 1-1/4" Casters, 2 with brake	300 lbs	12 lbs
WR-SB2R2*	Two Swivel 5" x 1-1/4" Thermoplastic Resin Caster with brake, 2 Rigid	300 lbs	12 lbs
WR-3	Four Swivel 3" Polyurethane Casters, all with brake	200 lbs	8 lbs
WR-RG*	One Rigid 5" x 1-1/4" Thermoplastic Resin Caster	300 lbs	3 lbs
WR-PS	One Swivel 8" x 2-1/2" Pneumatic Caster	325 lbs	4 lbs
Plate Casters			
PT-PS	One Swivel 5" x 1-1/4" Thermoplastic Resin Caster	300 lbs	3 lbs
PT-PR	One Rigid 5" x 1-1/4" Thermoplastic Resin Caster	300 lbs	3 lbs
PT-PSB	One Swivel 5" x 1-1/4" Thermoplastic Resin Caster with brake	300 lbs	3 lbs
PT-PS-S	One Swivel 5" x 1-1/4" Polyurethane Stainless Steel Caster with Zerk Grease Fittings	300 lbs	3 lbs
PT-PR-S	One Rigid 5" x 1-1/4" Polyurethane Stainless Steel Caster with Zerk Grease Fittings	300 lbs	3 lbs
PT-PSB-S	One Swivel 5" x 1-1/4" Polyurethane Stainless Steel Caster with brake with Zerk Grease Fittings	300 lbs	3 lbs
PT-PS6	One Swivel 6" x 2" Polyurethane Caster	800 lbs	5 lbs
PT-PR6	One Rigid 6" x 2" Polyurethane Caster	800 lbs	5 lbs
PT-PSB6	One Swivel 6" x 2" Polyurethane Caster with brake	800 lbs	5 lbs
PT-NS	One Swivel 8" x 2-1/2" Pneumatic Caster	325 lbs	4 lbs
PT-NR	One Rigid 8" x 2-1/2" Pneumatic Caster	325 lbs	4 lbs

*Requires Tie Bars for rigid alignment (See pg. 147)



WR-00H
Shown with and without brake
Sold as a set of 4 casters, 2 with brake



WR-00CO
Shown with and without brake
Sold as a set of 4 casters, 2 with brake



WR-00HS
Shown with and without brake
Sold as a set of 4 casters, 2 with brake



PT-PR

PT-PS



PT-PSB



PT-PR6



PT-PS6



PT-PSB6



WR-3
Sold as a set of 4 casters, all with brake



WR-PS



PT-NR



PT-NS



WR-RG
Requires Tie Bar
(See chart pg. 147)



Hamper

Single bag hamper offers foot activated metal heavy-duty lid for quick accessibility. Double ring bag holder allows for quick bag insertion and bag lock. Supports 36-42 gallon multi-purpose bags with a ring to keep bag in place. Four 3" casters (2 with brake) allows for easy mobility. **Finish:** Chrome

MODEL NO.	DIMENSIONS W" x L" x H"	SHIP WGT
18-M-HAMP	20" x 18" x 38"	21 lbs



36-42 GAL. CAPACITY

Sterile Wrap Carts

Hang bars keep sterile wraps separated and accessible for special preps. Bars are easy to adjust. Neoprene gaskets hold wraps in position. Two designs to choose from: cascading or low profile. **Finish:** Chrome

MODEL NO.	DIMENSIONS W" x L" x H"	SHIP WGT
Cascading, Sterile Wrap Cart		
WRC-SW2448	24" x 48" x 69"	103 lbs
WRC-SW2460	24" x 60" x 69"	110 lbs
Low Profile, Sterile Wrap Cart		
WRC-LPSW1863	18" x 63" x 39-1/2"	46 lbs

CARTS INCLUDE CASTER KIT FOR MOBILITY

1,200 lb. MOBILE LOAD CAPACITY

TWO DESIGNS AVAILABLE



LOW PROFILE

WRC-LPSW1863



CASCADING

WRC-SW2448



WRSC3-42-2436FS
24"W x 36"L x 48"H

Open Surgical Case Carts

Corrosion-free surgical case cart transports and delivers surgical instrumentation packs from the OR supply center to the operating room. **Finish:** 304 Stainless Steel

Each unit consists of:

- 4 - 42" stainless steel posts
- 2 - stainless steel wire shelves
- 1 - stainless steel solid shelf
- 1 - stainless steel 3-sided frame
- 1 - stainless steel push handle
- 4 - 5" swivel, stainless steel thermoplastic resin casters, 2 with brakes (casters come with Zerk grease fittings)

3 Sided Frames

Finish: 304 Stainless Steel

STAINLESS MODEL NO.	DIMENSIONS W" x L" x H"	SHIP WGT
2436FS	24" x 36"	8 lbs
2448FS	24" x 48"	9 lbs
2460FS	24" x 60"	10 lbs

MODEL NO.	DIMENSIONS W" x L" x H"	NO. OF SHELVES	SHIP WGT
WRSC3-42-2436FS	24" x 36" x 48"	3	77 lbs
WRSC3-42-2448FS	24" x 48" x 48"	3	88 lbs
WRSC3-42-2460FS	24" x 60" x 48"	3	106 lbs



WRSC4-54-2436FS
24"W x 36"L x 60"H

CARTS INCLUDE CASTER KIT FOR MOBILITY

1,200 lb. MOBILE LOAD CAPACITY

Each unit consists of:

- 4 - 54" stainless steel posts
- 3 - stainless steel wire shelves
- 1 - stainless steel solid shelf
- 1 - stainless steel 3-sided frame
- 1 - stainless steel push handle
- 4 - 5" swivel, stainless steel thermoplastic resin casters, 2 with brakes (casters come with Zerk grease fittings)

MODEL NO.	DIMENSIONS W" x L" x H"	NO. OF SHELVES	SHIP WGT
WRSC4-54-2436FS	24" x 36" x 60"	4	94 lbs
WRSC4-54-2448FS	24" x 48" x 60"	4	108 lbs
WRSC4-54-2460FS	24" x 60" x 60"	4	131 lbs



Adjustable from 3" - 27" under top shelf

SST-2436U
24"W x 36"L x 34"H

SST-MOB
4" Stainless Steel Casters

Stainless Steel Work Tables with Adjustable Underself



Heavy-duty 304 stainless steel processing tables are ideal for pack and prep in sterile environments. Units consist of a flat top work surface with hemmed edges and the lower flat bottom shelf is adjustable from 3" to 27" high. Tables are NSF approved. The support legs are 1-5/8" diameter with a leveling foot which can be converted to a mobile unit with a 4" stainless steel caster kit, all swivel and 2 with brake. (Sold separately) **Finish:** 304 Stainless Steel

MODEL NO.	DIMENSIONS W" x L" x H"	NO. OF SHELVES	SHIP WGT
Stationary Instrument Table with Shelf			
SST-2436U	24" x 36" x 34"	1	50 lbs
SST-2448U	24" x 48" x 34"	1	60 lbs
SST-2460U	24" x 60" x 34"	1	70 lbs
SST-2472U	24" x 72" x 34"	1	80 lbs
Mobile Kit			
SST-MOB	4 Swivel Casters, 2 with Brake		4 lbs



Catheter Cart - Complete with Bins

Uniquely designed, the catheter bin cart replaces the wire basket concept with color coded bins allowing for quicker identification. The combination of modular wire and plastic bins minimizes shrinkage and reduces unit cost. Bins are molded from high density polypropylene and are available in 7 colors. **Cart Finish:** Chrome

Bins available in: ● Blue ● Green ● Ivory ● Red ● Yellow ● Black
● Clear (One color per unit)

MODEL NO.	BIN DIMENSIONS L" x W" x H"	SHIP WGT
24"W x 48"L x 69"H - Wire Catheter Cart with 9 Wire Shelves Complete with 80 QSB105 Bins		
WRC9-63-2448-105	23-5/8" x 4-1/8" x 4"	246 lbs



WRC9-63-2448-105

**CARTS INCLUDE
CASTER KIT FOR
MOBILITY**

**1,200 lb.
MOBILE LOAD CAPACITY**



Catheter Hooks

Package includes 6 catheter hooks.
Finish: Chrome

MODEL NO.	DESCRIPTION	CTN WGT
Catheter Hooks - 6 Pack		
WR-CH	6 Catheter Hooks	2 lbs

Catheter Hold & Store Cart

The catheter hold and store cart allows separation and easy accessibility to pre-packed catheters. Ideal for central or OR supply centers, this style cart is modular in design. Includes 36 or 42 catheter hooks. **Finish:** Chrome

MODEL NO.	DIMENSIONS W" x L" x H"	SHIP WGT
Catheter Hold and Store Cart Includes 36 Catheter Hooks		
WRC-BC2448	24" x 48" x 69"	105 lbs
Catheter Hold and Store Cart Includes 42 Catheter Hooks		
WRC-BC2460	24" x 60" x 69"	125 lbs



WRC-BC2448
Shown with Dividable Grid Containers
Sold separately on pg. 67



WRCGR-63-2436



RACK AND CART COVERS
Protect against pilferage, airborne dust, moisture and other contaminants.

Stationary and Mobile Wire Garment Racks

Ideal storage rack for hanging any type of coat or garment. Includes handy bottom shelf for additional storage.

Finish: Chrome

Each unit consists of:

- 4 - 63" posts
- 2 - wire shelves
- 1 - hang bar (75 lb. hang capacity evenly distributed)

Mobile unit also includes:

- 4 - 5" swivel thermoplastic resin casters, 2 with brakes
- 4 - donut bumpers

MODEL NO.	DIMENSIONS W" x L" x H"	NO. OF SHELVES	SHIP WGT
Stationary Wire Garment Racks			
WRGR-63-2436	24" x 36" x 63"	2	45 lbs
WRGR-63-2448	24" x 48" x 63"	2	52 lbs
WRGR-63-2460	24" x 60" x 63"	2	63 lbs
Mobile Wire Garment Racks			
WRCGR-63-2436	24" x 36" x 69"	2	59 lbs
WRCGR-63-2448	24" x 48" x 69"	2	66 lbs
WRCGR-63-2460	24" x 60" x 69"	2	77 lbs

NYLON FABRIC OR CLEAR VINYL RACK AND CART COVERS AVAILABLE

See pg. 136

CARTS INCLUDE CASTER KIT FOR MOBILITY

1,200 lb. MOBILE LOAD CAPACITY



WRCP-63-2460

Patient Apparel Cart

Ideal for patient care situations where the distribution and holding of apparel is required. The horizontal bar accommodates hangers and the shelves are divided into separate visible compartments.

Finish: Chrome

Each unit consists of:

- 4 - 63" posts
- 2 - 54" posts
- 2 - 24"W x 60"L wire shelves
- 3 - 24"W x 36"L wire shelves
- 8 - 24" dividers
- 2 - 61" rods and tabs kits
- 1 - 24" hang bar (75 lb. hang capacity evenly distributed)
- 4 - 5" swivel thermoplastic resin casters, 2 with brakes
- 4 - donut bumpers

MODEL NO.	DIMENSIONS W" x L" x H"	NO. OF SHELVES	SHIP WGT
WRCP-63-2460	24" x 60" x 69"	5	146 lbs

Bin Transport Cart

The combination of bins and modular shelving creates a highly efficient method of visually identifying and transporting multiple items. The large capacity bins allow for color coding and the rotation of inventories. This multi-tasked unit is excellent for a wide variety of applications and transport solutions. **Cart Finish:** Chrome

Each unit consists of:

- 4 - 63" posts
- 2 - 54" posts
- 2 - 24"W x 60"L wire shelves
- 3 - 24"W x 36"L wire shelves
- 4 - 5" swivel thermoplastic resin casters, 2 with brakes
- 4 - donut bumpers
- 4 - QUS955 (23-7/8"L x 18-1/4"W x 12"H)

Bins available in: ● Blue ● Red ● Yellow ● Clear (One color per unit)

MODEL NO.	DIMENSIONS W" x L" x H"	NO. OF BINS	SHIP WGT
WRCPL-63-2460-955	24" x 60" x 69"	4 QUS955	165 lbs

COMPLETE PACKAGES WITH BINS



WRCPL-63-2460-955

CARTS INCLUDE CASTER KIT FOR MOBILITY

1,200 lb. MOBILE LOAD CAPACITY

Bin Transport Carts

Modular in design, the Bin Transport Cart provides an integrated system to transfer items. Carts enable you to color code, hold, or transport inventories and supplies. Ideal for use in central supply and laundry. Bins are autoclavable up to 250°F. **Cart Finish:** Chrome

Bins available in: ● Blue ● Red ● Yellow (One color per unit)

MODEL NO.	NO. OF SHELVES	NO. OF BINS	BIN DIMENSIONS L" x W" x H"	SHIP WGT
30"W x 36"L x 69"H - Wire Shelving Unit with HULK Containers				
WRC2-63-3036-974976	2	2	29-7/8" x 16-1/2" x 11"	150 lbs
		6	29-7/8" x 16-1/2" x 15"	
30"W x 36"L x 42"H - Wire Shelving Unit with HULK Containers				
WRC2-36-3036-976	2	4	29-7/8" x 16-1/2" x 15"	88 lbs



WRC2-36-3036-976



WRC2-63-3036-974976

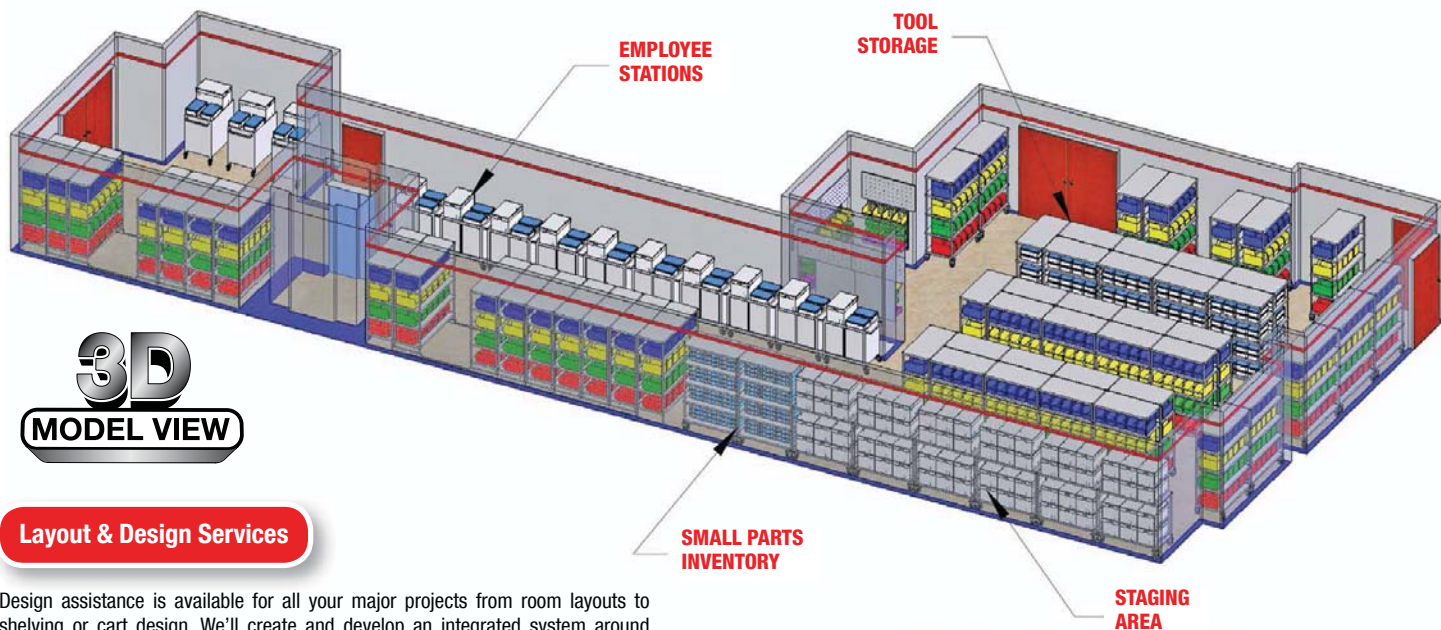

3D MODEL VIEW

Layout & Design Services

Design assistance is available for all your major projects from room layouts to shelving or cart design. We'll create and develop an integrated system around your requirements. Layouts can be created to accommodate your space with the appropriate product mix consisting of:

- Wire Shelving
- Stationary Shelving
- Bins
- Wall Systems
- Baskets
- Containers
- Hi-Density Mobile Track Systems
- Overhead Track Systems

TO ACHIEVE THE BEST RESULTS, PLEASE PROVIDE THE FOLLOWING INFORMATION:

- Room dimensions with door locations and door clearances, column locations (L x W) and ceiling height
- For shelving units, provide the number of shelf tiers, post height and indicate stationary or mobile
- If bins are required, indicate the appropriate size and whether they are to be used on shelving or wall mounted louvered panels

Quantum Storage offers the most complete package of storage products to satisfy all your requirements. Let us review your next project to maximize your storage space.

- Industry Exclusive 3D Modeling
- Revit Blueprint and AutoCAD Compatible
- Space Utilization and Maximization
- Plan-o-grams



DESIGN ASSISTANCE AVAILABLE

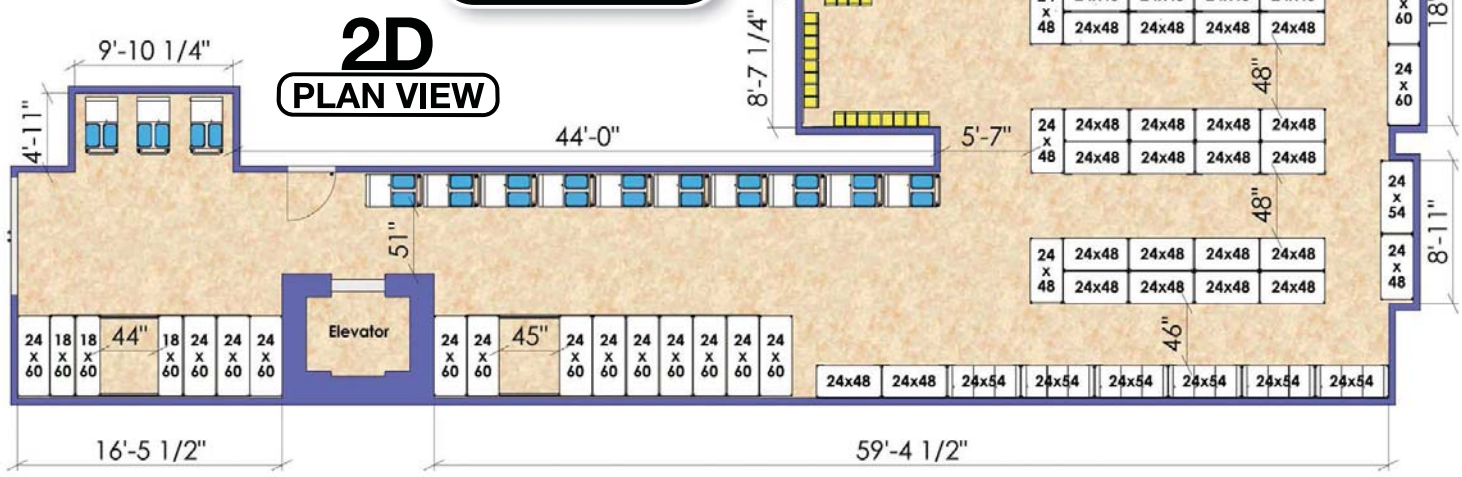

M1836CG47 - M2460CG47-5.....	137	PS-WS2414.....	126	QIC-270-122.....	95	QPRD-109CL.....	25	QRU-12D-240-48.....	12
M1836CG47RE - M2460CG47RE-5....	139	PT-NR.....	149	QIC-270-161.....	95	QPRD-110.....	50	QRU-12D-240-48CL.....	21
M1836SG46 - M2460SG46-5.....	137	PT-NS.....	149	QIC-270-64.....	95	QPRD18-000.....	50,62	QRU-1W - QRU-1WHC.....	11
M1836SG47 - M2460SG47-5.....	137	PT-PR - PT-PR6.....	149	QIC-270-83.....	95	QPRD18-6.....	55	QRU-12S.....	11
M1836SL34C-M2448SL34C.....	130	PT-PS - PT-PS6.....	149	QIC-4163.....	94	QPRD-201.....	55	QRU-12S-220-96.....	12
M1836SL6C - M2448SL6C.....	130	PT-PSB - PT-PSB6.....	149	QIC-4244.....	94	QPRD-201CL.....	27	QRU-12S-220-96CL.....	21
M2036BD - M2048BD.....	120	PWB.....	118	QIC-64.....	94	QPRD-202.....	55	QRU-12S-240-24.....	12
M2430CLAN.....	86	Q		QIC-8143.....	94	QPRD-202CL.....	27	QRU-12S-240-24CL.....	21
M2436-69SEC - M2460-69SEC.....	141	QB200 - QB900.....	80	QIC-8224.....	94	QPRD-203.....	55	QRU-16D.....	11
M2436-69SECP - M2460-69SECP.....	141	QBB-4845-34.....	72	QIC-83.....	94	QPRD-204.....	55	QRU-16D-230-96.....	12
M2436C46E - M2460C46E-5.....	140	QBC111.....	48,53,57	QIP-1819 - QLP-1819HC.....	8	QPRD-207.....	55	QRU-16D-230-96CL.....	21
MD1836C46RE - MD2460C46RE-5.....	138	QBC112.....	48,53,57	QLP-1819-210-16.....	12	QPRD-207CL.....	27	QRU-16S.....	11
MD1836C47RE - MD2460C47RE-5.....	138	QBR-1819.....	9	QLP-1819-210-16CL.....	21	QPRD-208.....	55	QRU-16S-220230240.....	12
MD1836CG46RE - MD2460CG46RE-5.....	139	QBR-2721.....	9	QLP-1819-220-16.....	12	QPRD-209.....	55	QRU-16S-220230240CL.....	21
MD1836CG47RE - MD2460CG47RE-5.....	139	QBR-2721-210-24.....	12	QLP-1819-220-16CL.....	21	QPRD-209CL.....	27	QRU-16S-230-48.....	12
MD2436-70SEC - MD2460-70SEC.....	141	QBR-2721-210-24CL.....	21	QLP-1819-230-9.....	12	QPRD-210.....	55	QRU-16S-230-48CL.....	21
MD2436-70SECP - MD2460-70SECP.....	141	QBR-2721-220-24.....	12	QLP-1819-230-9CL.....	21	QPRD-501.....	62	QRU-MOB.....	11,12,21
MESH-240.....	16	QBR-2721-230-12.....	12	QLP-1861 - QLP-1861HC.....	8	QPRD-5678.....	62	QS-000.....	92
MESH-240250.....	16	QBR-2721-230-12CL.....	21	QLP-2721.....	8	QPRD-6.....	55	QS-304-28.....	92
MESH-250.....	16	QBR-3612.....	9	QBR-3612.....	8	QPRD-601.....	62	QS-305306-52.....	92
MSU-16-MIX.....	46	QBR-3619.....	9	QLP-3619 - QLP3619HC.....	8	QPRD-602.....	62	QS-305-36.....	92
MSU-531.....	46	QBR-3619-210-32.....	12	QLP-3619-210-32.....	12	QPRD-604.....	62	QS-306-56.....	92
MSU-532.....	46	QBR-3619-210-32CL.....	21	QLP-3619-210-32CL.....	21	QPRD-606.....	62	QS-309-80.....	92
MSU-533.....	46	QBR-3619-220-32.....	12	QLP-3619-220-32.....	12	QPRD-701.....	62	QS-569-56.....	92
MSU-543.....	46	QBR-3619-220-32CL.....	21	QLP-3619-220-32CL.....	21	QPRD-801.....	62	QS-725.....	92
MTT-1842-543.....	74	QBR-3619-230-18.....	12	QLP-3619-230-18.....	12	QPRHA-000.....	50,62	QS-BIG-101.....	92
MTT-1860-543.....	74	QBR-3619-230-18CL.....	21	QLP-3661 - QLP-3661HC.....	8	QPRHA-100.....	50	QSB100.....	48
MTT-1878-543.....	74	QDC2012-7.....	71	QLP-3661-220-120.....	12	QPRHA-100CL.....	25	QSB100BR.....	81
MTT-3042-743.....	74	QDC2115-9.....	71	QLP-3661-220-120CL.....	21	QPRHA-101.....	25	QSB100CL.....	24
MTT-3060-743.....	74	QDC2115-12.....	71	QLP-3661-230-60.....	12	QPRHA-101CL.....	25	QSB100CO.....	83
MTT-3078-743.....	74	QDC2115-17.....	71	QLP-3661-230-60CL.....	21	QPRHA-102.....	50	QSB101.....	48
MWR4-2419-9.....	67	QDC21213-12.....	71	QLP-3661-240-28.....	12	QPRHA-102CL.....	25	QSB101BR.....	81
MWR5-1711-12.....	67	QDC2420-12.....	71	QLP-3661-240-28CL.....	21	QPRHA-107CL.....	25	QSB101CL.....	24
MWR7-1711-8.....	67	QDC2515-14.....	71	QLP-4819.....	8	QPRHA-109.....	50	QSB101CO.....	83
MWRS-5-92035.....	130	QDC2717-12.....	71	QLP-4861 - QLP-4861HC.....	8	QPRHA-109CL.....	25	QSB102.....	48
MWRS-5-92060.....	130	QDC2820-15.....	71	QLP-4861-220-165.....	12	QPRHA-201.....	55	QSB102BR.....	81
MWRS-5-92080.....	130	QDL-2115.....	71	QLP-4861-220-165CL.....	21	QPRHA-201CL.....	27	QSB102CL.....	24
MWRS-7-103.....	130	QDS300.....	89,91	QLP-4861-230-80.....	12	QPRHA-202.....	55	QSB102CO.....	83
MWRS-7-104.....	130	QDS-3666H.....	10	QLP-4861-230-80CL.....	21	QPRHA-202CL.....	27	QSB103.....	48
MWRS-7-108.....	130	QDU-00.....	50,55,62	QLP-4861-240-35.....	12	QPRHA-207.....	55	QSB103BR.....	81
MWRS-7-110.....	130	QDU-18.....	50,55,62	QLP-4861-240-35CL.....	21	QPRHA-207CL.....	27	QSB103CL.....	24
MWRS-7-602.....	130	QED401.....	60	QLR500.....	87,89	QPRHA-209.....	55	QSB103CO.....	83
MWRS-7-604.....	130	QED501.....	60	QMB510C.....	6	QPRHA-209CL.....	27	QSB104.....	48
MWRS-7-606.....	130	QED601.....	60	QMB520C.....	6	QPRHA-501.....	62	QSB104BR.....	81
		QED602.....	60	QMB524C.....	6	QPRHA-567.....	62	QSB104CL.....	24
		QED603.....	60	QMB530C.....	6	QPRHA-6.....	55	QSB104CO.....	83
		QED604.....	60	QMB534C.....	6	QPRHA-601.....	62	QSB105.....	48
		QED606.....	60	QMB535C.....	6	QPRHA-701.....	62	QSB105BR.....	81
		QED701.....	60	QMB539C.....	6	QPRS-000.....	50	QSB105CL.....	24
		QED801.....	60	QMB540C.....	6	QPRS-100.....	50,62	QSB105CO.....	83
N		QESTP.....	142	QMB550C.....	6	QPRS-100CL.....	25	QSB106.....	48
NPB1076.....	76	QFS124 - QFS270.....	91	QMB560C.....	6	QPRS-101.....	50	QSB106BR.....	81
O		QFS124-31.....	90	QMB565C.....	6	QPRS-101CL.....	25	QSB106CL.....	24
ORG80032.....	79	QFS148-38.....	90	QMB570C.....	6	QPRS-102.....	50	QSB106CO.....	83
ORG80322.....	79	QFS170-36.....	90	QMD-36H.....	10	QPRS-102CL.....	25	QSB107.....	48
ORG81532.....	79	QFS224-24+QFS400.....	91	QMD-36H-220.....	12	QPRS-103.....	50	QSB107BR.....	81
ORG81832.....	79	QFS224-24.....	90	QMD-36H-220CL.....	21	QPRS-103CL.....	25	QSB107CL.....	24
P		QFS248-76+QFS400.....	91	QMD-36H-230.....	12	QPRS-104.....	50	QSB107CO.....	83
P6BK - P96BK.....	99	QFS248-76.....	90	QMD-36H-230CL.....	21	QPRS-107.....	50	QSB107C0.....	48
P6C - P96C.....	99	QFS270-72+QFS400.....	91	QMD-36H-230CL.....	21	QPRS-107CL.....	25	QSB108.....	48
P6GY - P96GY.....	99	QFS270-72.....	90	QMD-36H-230240.....	12	QPRS-108.....	50	QSB108BR.....	81
P6P - P96P.....	99	QFS400.....	91,95	QMD-36H-230240CL.....	21	QPRS-109.....	50	QSB108CL.....	24
P6S - P96S.....	99	QGH600.....	42	QMD-36H-240.....	12	QPRS-109CL.....	25	QSB108CO.....	83
PC3518-33.....	75	QGH600CL.....	23	QMD-36H-240CL.....	21	QPRS-110.....	50	QSB109.....	48
PC3518-33-3.....	75	QGH700.....	42	QMS531.....	45	QPRS-110CL.....	25	QSB109BR.....	81
PC3518SHELF.....	75	QGH700BR.....	81	QMS531BR.....	45	QPRS18-000.....	50,62	QSB109CL.....	24
PC4026-33.....	75	QGH700CL.....	23	QMS532.....	45	QPRS18-6.....	55	QSB109CO.....	83
PC4026-33-3.....	75	QGH705MOB.....	42	QMS532BR.....	45	QPRS-201.....	55	QSB110.....	48
PC4026SHELF.....	75	QGH705MOBCL.....	23	QMS533.....	45	QPRS-201CL.....	27	QSB110BR.....	81
PC-CAS-RG - PC-CAS-SW.....	75	QGH800.....	42	QMS533BR.....	81	QPRS-202.....	55	QSB110CL.....	24
PCL1 - PCL2.....	147	QGH800CL.....	23	QMS543.....	45	QPRS-202CL.....	27	QSB110CO.....	83
PCTH.....	75	QGH805MOB.....	42	QMS743.....	45	QPRS-203.....	55	QSB114.....	48
PDC-12BK.....	78	QGH805MOBCL.....	23	QMS743BR.....	81	QPRS-204.....	55	QSB114BR.....	81
PDC-18BK.....	78	QIC-12123.....	94	QMS843MOB.....	45	QPRS-207.....	55	QSB114CL.....	24
PDC-22BK.....	78	QIC-122.....	94	QP965.....	63	QPRS-207CL.....	27	QSB114CO.....	83
PDC-39BK.....	78	QIC-124-122.....	95	QP1265.....	63	QPRS-208.....	55	QSB116.....	48
PDC-60BK.....	78	QIC-124-161.....	95	QP1285.....	63	QPRS-209.....	55	QSB116BR.....	81
PDC-930BK.....	78	QIC-124-64.....	95	QP1496.....	63	QPRS-209CL.....	27	QSB116CL.....	24
PFTC4026-33-2.....	75	QIC-124-83.....	95	QP1867.....	63	QPRS-210.....	55	QSB116CO.....	83
PFTC4026-33-3.....	75	QIC-148-122.....	95	QP1887.....	63	QPRS-501.....	62	QSB201.....	53
PH18 - PH36.....	147	QIC-148-161.....	95	QPR-101.....	16	QPRS-5678.....	62	QSB201CL.....	26
PH18BK - PH24BK.....	147	QIC-148-64.....	95	QPR-102.....	16	QPRS-6.....	55	QSB202.....	53
PH18GY - PH36GY.....	147	QIC-148-83.....	95	QPR-107.....	16	QPRS-601.....	62	QSB202CL.....	26
PH18P - PH36P.....	147	QIC-161.....	94	QPRD-000.....	50,62	QPRS-602.....	62	QSB203.....	53
PH18S - PH36S.....	147	QIC-170-122.....	95	QPRD-100.....	50	QPRS-604.....	62	QSB203CL.....	26
PLH1X6C - PLH2X4C.....	99	QIC-170-161.....	95	QPRD-100CL.....	25	QPRS-606.....	62	QSB204.....	53
PS-A2475-7S.....	125	QIC-170-64.....	95	QPRD-101.....	50	QPRS-701.....	62	QSB204CL.....	26
PS-A2475-8WB.....	125	QIC-170-83.....	95	QPRD-101CL.....	25	QPRS-801.....	62	QSB205.....	53
PS-DBC-14S.....	126	QIC-170-83.....	95	QPRD-102.....	50	QRB166.....	40	QSB205CL.....	26
PS-DBC-14WB.....	126	QIC-224-122.....	95	QPRD-102CL.....	25	QRB176MOB.....	40	QSB206.....	53
PS-DBC-7WB7S.....	126	QIC-224-161.....	95	QPRD-103.....	50	QRB206.....	40	QSB206CL.....	26
PS-LH3.....	123,124	QIC-224-83.....	95	QPRD-104.....	50	QRB216MOB.....	40	QSB207.....	53
PS-S2475-7S.....	125	QIC-248-122.....	95	QPRD-104CL.....	25	QRB246.....	40	QSB207CL.....	26
PS-S2475-8WB.....	124	QIC-248-161.....	95	QPRD-107.....	50	QRB256MOB.....	40	QSB208.....	53
PS-SBC58-6S.....	125	QIC-248-64.....	95	QPRD-107CL.....	25	QRC-4D.....	18	QSB208CL.....	26
PS-SBC58-6WB.....	125	QIC-248-83.....	95	QPRD-108.....	50	QRU-12D.....	11	QSB209.....	53
PS-SE - PS-SSE.....	126	QIC-248-83.....	95	QPRD-109.....	50	QRU-12D-220-192.....	12	QSB209CL.....	26
PS-WB22143 - PS-WB22148.....	126			QPRD-109CL.....	25			QSB210.....	53
PS-WBLD-3 - PS-WBLD-8.....	126								
PS-WBLS-3 - PS-WBLS-8.....	126								

QSB210CL.....26	QTB309.....87	QUS275MOBCL.....20	snt195CL.....30	WR10-230240.....14
QSB214.....53	QTB405.....88	QUS950.....34	snt200.....66	WR10-230240CL.....20
QSB214CL.....26	QTB406.....88	QUS950CL.....22	snt200CL.....30	WR12-101 - WR12-116.....51
QSB216.....53	QTB409.....88	QUS951.....34	snt225.....66	WR12-101CL - WR12-116CL.....24
QSB216CL.....26	QTB410.....88	QUS951CL.....22	snt225CL.....30	WR12-101CO - WR12-116CO.....83
QSB801.....57	QTB411.....88	QUS952.....34	snt230.....66	WR12-93030.....67
QSB801CL.....28	QTB412.....88	QUS952CL.....22	snt230CL.....30	WR12-93030CL.....31
QSB802.....57	QTB669.....88	QUS953.....34	snt240.....66	WR-3.....108,149
QSB802CL.....28	QTB-LP-BKT.....87,112	QUS953CL.....22	snt240CL.....30	WR4-12225.....67
QSB803.....57	QTB-SPIN148.....93	QUS954.....34	snt300.....66	WR4-12225CL.....30
QSB803CL.....28	QTF24.....89	QUS954CL.....22	snt300CL.....30	WR4-39-1236-801.....59
QSB804.....57	QTF320.....89	QUS955.....34	SSB423.....32	WR4-39-1236-801CL.....29
QSB804CL.....28	QTF320-42.....89	QUS955CL.....22	SSB425.....32	WR4-39-1236-802.....59
QSB805.....57	QTF48.....89	QUS957.....34	SSB441.....32	WR4-39-1236-802CL.....29
QSB805CL.....28	QTF70.....89	QUS957CL.....22	SSB443.....32	WR4-39-1236-807.....59
QSB806.....57	QTR24.....89	QUS964MOB.....34	SSB445.....32	WR4-39-1236-807CL.....29
QSB806CL.....28	QTR48.....89	QUS964MOBCL.....22	SSB461.....32	WR4-39-1236-809.....59
QSB807.....57	QTR70.....89	QUS965MOB.....34	SSB463.....32	WR4-39-1236-809CL.....29
QSB807CL.....28	QUS200.....5	QUS965MOBCL.....22	SSB465.....32	WR5-270.....14
QSB808.....57	QUS200BR.....81	QUS967MOB.....34	SSB483.....32	WR5-270CL.....20
QSB808CL.....28	QUS200CL.....20	QUS967MOBCL.....22	SSB485.....32	WR5-36MSBA.....120
QSB809.....57	QUS200CO.....82	QUS970.....37	SST-2436U - SST-2472U.....151	WR5-36MSBA-MOB.....120
QSB809CL.....28	QUS210.....5	QUS973.....37	SST-MOB.....151	WR5-39-1236-201.....56
QSB810.....57	QUS210BR.....81	QUS974.....37	T	WR5-39-1236-201CL.....26
QSB810CL.....28	QUS210CL.....20	QUS975.....37	TB12 - TB12CL.....76	WR5-39-1236-202.....56
QSB814.....57	QUS210CO.....82	QUS976.....37	TBC-32WT.....93	WR5-39-1236-202CL.....26
QSB814CL.....28	QUS220.....5	QUS984MOB.....37	TC-19 - TC-39.....135	WR5-39-1236-207.....56
QSB816.....57	QUS220BR.....81	QUS985MOB.....37	TC-19CO - TC-39CO.....85	WR5-39-1236-207CL.....26
QSB816CL.....28	QUS220CL.....20	QUS986MOB.....37	TC-500.....76	WR5-39-1236-209.....56
QSB816CL.....28	QUS220CO.....82	QUS993.....37	TC-EL38.....135	WR5-39-1236-209CL.....26
QSB816CL.....28	QUS221.....5	QUS994MOB.....37	TC-EL38CO.....85	WR54-1236BK - WR54-3672BK-5.....100
QSB816CL.....28	QUS221BR.....81	QUS995.....37	TK-2 - TK-7.....144	WR54-1236C - WR54-3672C-5.....100
QSB816CL.....28	QUS221CL.....20	QUS996MOB.....37	TK-CA.....144	WR54-1236GY - WR54-3672GY-5.....100
QSB816CL.....28	QUS222.....5	QUS997.....37	TK-CBW.....144	WR54-1236P - WR54-3672P-5.....100
QSB816CL.....28	QUS224BR.....81	QUS998MOB.....37	TK-DTB18 - TK-DTB24.....144	WR54-1236S - WR54-3672S-5.....100
QSB816CL.....28	QUS224CL.....20	QVTRK.....142	TK-EP.....144	WR54-1436SG - WR54-2472SG.....104
QSB816CL.....28	QUS230.....5	QVTRK-2-72EST - QVTRK-2-240EST.....143	TK-STB18 - TK-STB24.....144	WR54-1436SG-5 - WR54-2472SG-5.....105
QSB816CL.....28	QUS230BR.....81	QVTRK-3-72EST - QVTRK-3-240EST.....143	TR1-2516-8.....69	WR5-533.....47
QSB816CL.....28	QUS230CL.....20	R	TR2-2516-8.....69	WR5-543.....47
QSB816CL.....28	QUS230CO.....82	RLHX3C.....77	TR3-2516-8.....69	WR5-600.....44
QSB816CL.....28	QUS232.....5	RP63E - RP72E.....109	TR4-2516-8.....69	WR5-600CL.....23
QSB816CL.....28	QUS232BR.....81	RP1830E - RP2472E.....109	TR5-2516-8.....69	WR5-600CL.....23
QSB816CL.....28	QUS232CL.....20	RPWR72-1830E - RPWR72-2472E.....109	TR6-2516-8.....69	WR5-600800.....44
QSB816CL.....28	QUS234.....5	RSO1207-5.....70	TR12-2516-8.....69	WR5-600800CL.....23
QSB816CL.....28	QUS234BR.....81	RSO1215-5.....70	TR-96.....75	WR5-700.....44
QSB816CL.....28	QUS234CL.....20	RSO1215-7.....70	TS18C - TS24C.....135	WR5-700CL.....23
QSB816CL.....28	QUS235.....5	RSO2415-5.....70	TS32C - TS62C.....135	WR5-800.....44
QSB816CL.....28	QUS235BR.....81	RSO2415-7.....70	TT-C9 - TT-C15.....73	WR5-800CL.....23
QSB816CL.....28	QUS235CL.....20	RSO2415-9.....70	TTD-30 - TTD-40.....73	WR5-955.....36
QSB816CL.....28	QUS235CO.....82	RSO2422-11.....70	TTD-OT15-240.....73	WR5-955CL.....22
QSB816CL.....28	QUS236.....5	RWR72-1830LD - RWR72-2448LD.....108	TTK-8 - TTK-21.....145	WR5-975.....38
QSB816CL.....28	QUS236BR.....81	S	TTK-C18 - TTK-C24.....145	WR5-993.....39
QSB816CL.....28	QUS236CL.....20	SCH1 - SCH1-5.....146	TTK-E18 - TTK-E24.....145	WR5-995.....39
QSB816CL.....28	QUS238.....5	SD36C - SD60C.....141	TTK-M18 - TTK-M24.....145	WR5-997.....39
QSB816CL.....28	QUS238BR.....81	SD36P - SD60P.....141	TT-OT9 - TT-OT15.....73	WR6-13-MIX.....47
QSB816CL.....28	QUS238CL.....20	SG-1830P - SG-3354P.....116	TTS-18 - TTS-24.....73	WR6-191507 - WR6-191507CL.....64
QSB816CL.....28	QUS239.....5	SG-B1357P - SG-B17710P.....117	TUB1711-8.....68	WR6-24185.....67
QSB816CL.....28	QUS239BR.....81	SG-BH29P.....117	TUB1711-12.....68	WR6-24185CL.....30
QSB816CL.....28	QUS239CL.....20	SG-BR6P.....117	TUB2417-8.....20	WR6-260.....14
QSB816CL.....28	QUS239CO.....82	SG-CD14P - SG-CD24P.....117	TUB2417-12.....68	WR6-260CL.....20
QSB816CL.....28	QUS240.....5	SG-CH.....117	TUB2419-9.....68	WR6-265.....14
QSB816CL.....28	QUS240BR.....81	SG-CMBP.....117	TUB2516-8.....68	WR6-265CL.....20
QSB816CL.....28	QUS240CL.....20	SG-CS14P - SG-CS24P.....117	U	WR63-1236BK - WR63-3672BK-5.....101
QSB816CL.....28	QUS240CO.....82	SG-DWB.....117	UB10.....148	WR63-1236C - WR63-3672C-5.....101
QSB816CL.....28	QUS241.....5	SG-GBHP.....117	UH18 - UH24.....147	WR63-1236GY - WR63-3672GY-5.....101
QSB816CL.....28	QUS241BR.....81	SG-HFF.....117	UH18BK - UH24BK.....147	WR63-1236P - WR63-3672P-5.....101
QSB816CL.....28	QUS241CL.....20	SG-HOOK6P - SG-HOOKLG.....117	UH18GY - UH24GY.....147	WR63-1236S - WR63-3672S-5.....101
QSB816CL.....28	QUS242.....5	SG-IPH.....117	UH18P - UH24P.....147	WR63-1436SG - WR63-2472SG.....104
QSB816CL.....28	QUS242BR.....81	SG-LGBH.....117	UH18S - UH24S.....147	WR63-1436SG-5 - WR63-2472SG-5.....105
QSB816CL.....28	QUS242CL.....20	SG-LH1384P.....117	W	WR6-36-1236-101.....51
QSB816CL.....28	QUS245.....5	SG-PWM.....117	W7-12-24.....63	WR6-36-1236-101CL.....24
QSB816CL.....28	QUS245BR.....81	SG-S918P - SG-S1224P.....117	W7-12-26.....63	WR6-36-1236-101CO.....83
QSB816CL.....28	QUS245CL.....20	SG-SBH.....117	W7-12-28.....63	WR6-36-1236-102.....51
QSB816CL.....28	QUS248.....5	SG-SLH201412P.....117	W7-12-30.....63	WR6-36-1236-102CL.....24
QSB816CL.....28	QUS248BR.....81	SG-SMBH.....117	W7-14-18.....63	WR6-36-1236-102CO.....83
QSB816CL.....28	QUS248CL.....20	SG-SR2254P.....117	W7-18-24.....63	WR6-36-1236-107.....51
QSB816CL.....28	QUS250.....5	SG-TDR461410P.....117	W7-18-26.....63	WR6-36-1236-107CL.....24
QSB816CL.....28	QUS250BR.....81	SG-U16P - SG-U44P.....116	W7-18-28.....63	WR6-36-1236-107CO.....83
QSB816CL.....28	QUS250CL.....20	SG-UH4P - SG-UH10P.....117	W7-18-30.....63	WR6-36-1236-109.....51
QSB816CL.....28	QUS250CO.....82	SG-WT40P - SG-WT72P.....116	WCSD-1814 - WCSD-2420.....146	WR6-36-1236-109CL.....24
QSB816CL.....28	QUS255.....5	S-HOOK - S-HOOKSS.....148	WGH600 - WGH800.....23,42	WR6-36-1236-109CO.....83
QSB816CL.....28	QUS255BR.....81	SK.....142	WH-15.....76	WR6-36-1236-109CL.....36
QSB816CL.....28	QUS255CL.....20	SL12 - SL30.....147	WK.....142	WR6-953.....36
QSB816CL.....28	QUS255CO.....82	SL12BK - SL24BK.....147	WLP-1836C.....7,82	WR6-953CL.....22
QSB816CL.....28	QUS260.....5	SL12GY - SL24GY.....147	WLP-3036C.....7,82	WR6-953954CL.....22
QSB816CL.....28	QUS260BR.....81	SL12P - SL24P.....147	WLP-3048C.....7,82	WR6-954.....36
QSB816CL.....28	QUS260CL.....20	SL12S - SL30S.....147	WLP-DMC.....7	WR6-954CL.....22
QSB816CL.....28	QUS260CO.....82	SLP-A1236 - SLP-A1836.....9	WLP-OSC.....7	WR6-957.....36
QSB816CL.....28	QUS265.....5	SLP-1236 - SLP-1836.....9	WMS531 - WMS543.....45	WR6-957CL.....22
QSB816CL.....28	QUS265BR.....81	snh010.....66,68,77	W-PC.....99	WR6-973.....38
QSB816CL.....28	QUS265CL.....20	snt180.....66	W-PC-STUD.....99	WR6-973974.....38
QSB816CL.....28	QUS270.....5	snt180CL.....30	W-PLB.....99	WR6-974.....38
QSB816CL.....28	QUS270BR.....81	snt185.....66	W-PLI.....99	WR7-20-MIX.....36
QSB816CL.....28	QUS270CL.....20	snt185CL.....30	WR-00CO.....149	WR7-20-MIXCL.....24
QSB816CL.....28	QUS270CO.....82	snt190.....66	WR-00H.....149	WR7-245CL.....20
QSB816CL.....28	QUS275MOB.....5	snt190CL.....30	WR-00H-5.....111	WR74-1236BK - WR74-3672BK-5.....102
QSB816CL.....28	QUS275MOBCL.....81	snt195.....66	WR-00HS.....149	WR74-1236C - WR74-3672C-5.....102

WR74-1236GY - WR74-3672GY-5 102	WR8-801 59	WRC-1836-3G - WRC-1848-3G 134	WR-RG..... 149	WS-HBBA-D..... 115
WR74-1236P - WR74-3672P-5 102	WR8-801CL 29	WRC-1836BK-2 - WRC-1848BK-2 134	WR-S24W..... 132,133	WS-HBB-D..... 115
WR74-1236S - WR74-3672S-5 102	WR8-802 59	WRC-1836BK-3 - WRC-1848BK-3 134	WRS4-54-1436SS -	WS-HDS1 9,115
WR74-1248-101102 52	WR8-802CL 29	WRC-1836GY-2 - WRC-1848GY-2 134	WRS4-86-2472SS 106	WS-HDS6 9,115
WR74-1248-110101 52	WR8-803 59	WRC-1836GY-3 - WRC-1848GY-3 134	WRS5-54-1436SS -	WS-HTH 9,115
WR74-1248-66102 52	WR8-803CL 29	WRC-1836P-2 - WRC-1848P-2 134	WRS5-86-2472SS 107	WS-MOB..... 112
WR74-1260-101102 52	WR8-804 59	WRC-1836P-3 - WRC-1848P-3 134	WRS-5-92035 130	WS-PM18HC 114
WR74-1260-143101 52	WR8-804CL 29	WRC2-1836-1265 63	WRS-5-92060 130	WS-PM36HC 114
WR74-1260-88102 52	WR8-805 59	WRC2-1836-1285 63	WRS-5-92080 130	WS-PM48HC 114
WR74-1272-101102 52	WR8-805CL 29	WRC2-1836-1867 63	WRS-7-103 130	WS-SR9C 9,115
WR74-1272-110102 52	WR8-806 59	WRC2-1836-1887 63	WRS-7-104 130	WS-SSMOB 112
WR74-1272-176101 52	WR8-806CL 29	WRC2-36-3036-976 154	WRS-7-108 130	WS-VTH 9,115
WR74-1436SG - WR74-2472SG 104	WR8-807 59	WRC-2436-2 - WRC-2448-2 134	WRS-7-110 130	WUS221 - WUS270 5
WR74-1436SG-5 -	WR8-807CL 29	WRC-2436-2CG - WRC-2448-2CG 134	WRS-7-602 130	WUS950 - WUS957 34
WR74-2472SG-5 105	WR8-808 59	WRC-2436-2CG - WRC-2448-2CG 85	WRS-7-604 130	WUS970 - WUS976 37
WR74-1836CRNC -	WR8-808CL 29	WRC-2436-2G - WRC-2448-2G 134	WRS-7-606 130	
WR74-1836CRNC-5 110	WR8-809 59	WRC-2436-3 - WRC-2448-3 134	WRSAD4-54-1436SS -	
WR74-1848-103104 52	WR8-809CL 29	WRC-2436-3CG - WRC-2448-3CG 134	WRSAD4-86-2472SS 106	
WR74-1848-110103 52	WR8-810 59	WRC-2436-3CG - WRC-2448-3CG 85	WRSAD5-54-1436SS -	
WR74-1848-66104 52	WR8-810CL 29	WRC-2436-3G - WRC-2448-3G 134	WRSAD5-86-2472SS 107	
WR74-1860-103104 52	WR8-814 59	WRC-2436BK-2 - WRC-2448BK-2 134	WR-SB2R2 149	
WR74-1860-143103 52	WR8-814CL 29	WRC-2436BK-3 - WRC-2448BK-3 134	WRSC-1836-2 - WRSC-1848-2 134	
WR74-1860-88104 52	WR8-816 59	WRC-2436GY-2 - WRC-2448GY-2 134	WRSC-1836-2SS -	
WR74-1872-103104 52	WR8-816CL 29	WRC-2436GY-3 - WRC-2448GY-3 134	WRSC-1848-2SS 134	
WR74-1872-110104 52	WR8-950 36	WRC-2436P-2 - WRC-2448P-2 134	WRSC-1836-3 - WRSC-1848-3 134	
WR74-1872-176103 52	WR8-950952CL 22	WRC-2436P-3 - WRC-2448P-3 134	WRSC-1836-3SS 134	
WR74-2436C-22D 86	WR8-950CL 22	WRC2-63-3036-974976 154	WRSC-1848-3SS 134	
WR74-2442CRNC -	WR8-952 36	WRC3-1836-1265 63	WRSC-1836SS-2S -	
WR74-2442CRNC-5 110	WR8-952CL 22	WRC3-1836-1285 63	WRSC-1848SS-2S 134	
WR74-2448-105106 52	WR8-970 38	WRC3-1836-1867 63	WRSC-1836SS-3S -	
WR74-2448-110105 52	WR9-201 56	WRC3-1836-1887 63	WRSC-1848SS-3S 134	
WR74-2448-66106 52	WR9-201CL 26	WRC5-63-2436-93060 -	WRSC-2436-2 - WRSC-2448-2 134	
WR74-2460-105106 52	WR9-202 56	WRC5-63-2460-93060 132	WRSC-2436-2SS -	
WR74-2460-143105 52	WR9-202CL 26	WRC74-BSK1824C-5 -	WRSC-2448-2SS 134	
WR74-2460-88106 52	WR9-203 56	WRC74-BSK2460C-5 122	WRSC-2436-3 - WRSC-2448-3 134	
WR74-2472-105106 52	WR9-203CL 26	WRC9-63-2448-105 152	WRSC-2436-3SS -	
WR74-2472-110106 52	WR9-204 56	WRC-BC2448 - WRC-BC2460 152	WRSC-2448-3SS 134	
WR74-2472-176105 52	WR9-204CL 26	WRCGR-63-2436 -	WRSC-2436SS-2S -	
WR7-532 47	WR9-205 56	WRCGR-63-2460 153	WRSC-2448SS-2S 134	
WR7-92080 67	WR9-205CL 26	WR-CH 152	WRSC-2436SS-3S -	
WR7-92080CL 31	WR9-206 56	WRC-IT-1824 134	WRSC-2448SS-3S 134	
WR7-951 36	WR9-206CL 26	WRC-LPSW1863 150	WRSC3-42-2436FS -	
WR7-951CL 22	WR9-207 56	WRCP-63-2460 153	WRSC3-42-2460FS 151	
WR8-239 14	WR9-207CL 26	WRCP-63-2460-955 154	WRSC4-54-2436FS -	
WR8-239CL 20	WR9-208 56	WRC-R60C 111	WRSC4-54-2460FS 151	
WR8-240 14	WR9-208CL 26	WRC-R264C 86,111	WR-DFP 148	
WR8-240CL 20	WR9-209 56	WRC-R468C 111	WR-SFP 148	
WR8-245CL 20	WR9-209CL 26	WRCS4-63-2436EP -	WRSL6-74-1848-260 130	
WR8-250 14	WR9-210 56	WRCS4-63-2460EP-5 140	WRSL6-74-2448-953 130	
WR8-250CL 20	WR9-210CL 26	WRCS4-74-2436EP -	WR-SP 148	
WR8-255 14	WR9-214 56	WRCS4-74-2460EP-5 140	WR-SS - WR-SSCO 148	
WR8-255CL 20	WR9-214CL 26	WRCSL5-63-1836 -	WR-WMB 148	
WR8-423 33	WR9-216 56	WRCSL5-63-2448 131	WS-1218DSHC - WS-1848DSHC 115	
WR8-425 33	WR9-216CL 26	WRCSL5-63-1836-104 -	WS70-DS18ADHC -	
WR8-441 33	WR9-36180 67	WRCSL5-63-2448-106 131	WS70-DS48ADHC 114	
WR8-443 33	WR9-36180CL 30	WRCSL5-63-1836EP -	WS70-DS18HC - WS70-DS48HC 114	
WR8-445 33	WR9-531 47	WRCSL5-63-2448EP 131	WS70-SS18-4S3L -	
WR8-461 33	WR9-92060 67	WRCSL5-63-1836EP-104 -	WS70-SS18AD-7S 113	
WR8-463 33	WR9-92060CL 31	WRCSL5-63-2448EP-106 131	WS70-SS18ADHC -	
WR8-465 33	WR9-93060 67	WRCSL5-74-1836-104220 -	WS70-SS48ADHC 114	
WR8-483 33	WR9-93060CL 31	WRCSL5-74-1848-104220 131	WS70-SS18HC - WS70-SS48HC 114	
WR8-483485 33	WRA86-2136C-166 41	WRCSL6-74-1848-260 130	WS70-SS36-4S3L -	
WR8-485 33	WRA86-2142C-206 41	WRCSL6-74-2448-953 130	WS70-SS36AD-7S 113	
WR86-1236BK - WR86-3672BK-5 103	WRA86-2154C-166 41	WRC-SW2448 - WRC-SW2460 150	WS70-SS48-4S3L -	
WR86-1236G - WR86-3672G-5 103	WRC-1836-2 - WRC-1848-2 134	WR-D24W 133	WS70-SS48AD-7S 113	
WR86-1236GY - WR86-3672GY-5 103	WRC-1836-2CG - WRC-1848-2CG 134	WRDBS4-63-2436EP -	WS-DR10C 9,115	
WR86-1236P - WR86-3672P-5 103	WRC-1836-2CG - WRC-1848-2CG 85	WRDBS4-63-2460EP-5 140	WS-DSMOB 112	
WR86-1236S - WR86-3672S-5 103	WRC-1836-2G - WRC-1848-2G 134	WRDBS4-74-2436EP -	WS-HB36HC 115	
WR86-1436SG - WR86-2472SG 104	WRC-1836-3 - WRC-1848-3 134	WRDBS4-74-2460EP-5 140	WS-HB48HC 115	
WR86-1436SG-5 -	WRC-1836-3CG - WRC-1848-3CG 134	WRGR-63-2436 - WRGR-63-2460 153	WS-HBB 115	
WR86-2472SG-5 105	WRC-1836-3CG - WRC-1848-3CG 85	WR-PS 149	WS-HBBA 115	

COLOR OPTION ORDERING INSTRUCTIONS

In order to properly process your order, please include a color code suffix to any model number available with color options.

Use the two letter abbreviation listed below and add them to the end of the model number without any spaces or dashes.

(i.e. *QSB101* in Blue would be submitted as *QSB101BL*)

BK BLACK

BL BLUE

BR RECYCLED

CL CLEAR

CO CONDUCTIVE

GN GREEN

GY GRAY

IV IVORY

OR ORANGE

PK PINK

PU PURPLE

RD RED

SN STONE

WT WHITE

YL YELLOW

VISIT US ONLINE

to view our full product line

WWW.QUANTUMSTORAGE.COM

Great storage products, delivered quickly at the guaranteed lowest prices. Contact Quantum Storage Systems today and revolutionize the way you organize!



CATALOG NO. 030120

CORPORATE HEADQUARTERS

15800 NW 15th Avenue
Miami, FL 33169
Phone (305) 687-0405
Fax (305) 688-2790

Toll Free **1-800-685-4665**
sales@quantumstorage.com

MIDWEST DISTRIBUTION CENTER

2600 United Lane
Elk Grove Village, IL 60007
Phone (305) 687-0405
Fax (305) 688-2790

Toll Free **1-800-685-4665**
sales@quantumstorage.com

WEST COAST DISTRIBUTION CENTER

4603 N Brawley Avenue Suite 103
Fresno, CA 93722
Phone (559) 275-2467
Fax (559) 275-3249

sales@quantumwestcoast.com

CANADA DISTRIBUTION CENTER

1624 Concession Road
Cambridge, Ontario N3H 4L9
Phone (519) 653-8848
Fax (519) 653-7989

Toll Free **1-888-653-8848**
quantumstorage@bellnet.ca